

LANIER

Operator Guide

5505/5485

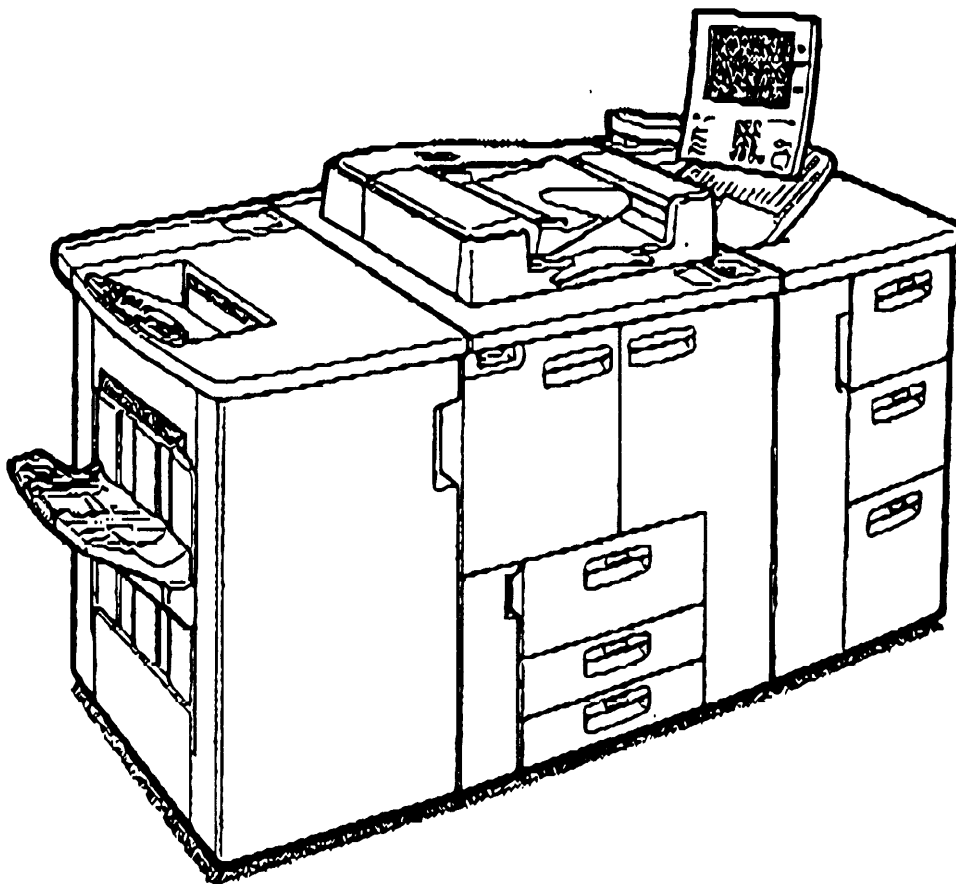

Digital Copier

When ordering supplies or requesting service for your copier, you will need to provide the model and serial number of your machine.

Please take a moment to enter your model and serial numbers here.

MODEL NUMBER: _____

SERIAL NUMBER: _____

To order supplies, call: () _____

To request service, call: () _____



Customer Vision® -
Our commitment to your
complete satisfaction



As an Energy Star Partner, Lanier Worldwide, Inc. has determined that this product meets the Energy Star guidelines for energy efficiency.

Introduction

This manual contains detailed instructions on the operation and maintenance of this machine. To get maximum versatility from this machine all operators should carefully read and follow the instructions in this manual. Please keep this manual in a handy place near the machine.

Please read the Safety Information before using this machine. It contains important information related to USER SAFETY and PREVENTING EQUIPMENT PROBLEMS.



Notes

Some illustrations may be slightly different from your machine.

Certain options may not be available in some countries. For details, please contact your local dealer.



Operator Safety

This machine is considered a CDRH Class I laser device, safe for office/EDP use. The machine contains a 10-milliwatt, 770-810 nanometer wavelength, GaAlAs laser diode. Direct (or indirect reflected) eye contact with the laser beam might cause serious eye damage. Safety precautions and interlock mechanism have been designed to prevent any possible laser beam exposure to the operator.

Laser Safety:

The Center for Devices and Radiological Health (CDRH) prohibits the repair of laser-based optical unit in the field. The optical housing unit can only be repaired in a factory or at a location with the requisite equipment. The laser subsystem is replaceable in the field by a qualified Customer Engineer. The laser chassis is not repairable in the field. Customer engineers are therefore directed to return all chassis and laser subsystems to the factory or service depot when replacement or the optical subsystem is required.

Warning:

Use of controls or adjustment or performance of procedures other than those specified in this manual might result in hazardous radiation exposure.

Two kinds of size notation are employed in this manual. With this machine refer to the inch version.

For good copy quality, Ricoh recommends that you use genuine Ricoh toner.

Ricoh shall not be responsible for any damage or expense that might result from the use of parts other than genuine Ricoh parts in your Ricoh office product.

Power Source

240V, 60Hz, 20 A or more

Please be sure to connect the power cord to a power source as above. For details about power source, see ⇒ P.335 "Power Connection".

In accordance with IEC 60417, this machine uses the following symbols for the main power switch:

I means **POWER ON.**

⏻ means **STAND BY.**

Safety Information

When using your equipment, the following safety precautions should always be followed.

Safety During Operation

In this manual, the following important symbols are used:

 **WARNING:**
Indicates a potentially hazardous situation which, if instructions are not followed, could result in death or serious injury.

 **CAUTION:**
Indicates a potentially hazardous situation which, if instructions are not followed, may result in minor or moderate injury or damage to property.

⚠ WARNING:

- ***Connect the power cord directly into a wall outlet and never use an extension cord.***
- ***Disconnect the power plug (by pulling the plug, not the cable) if the power cable or plug becomes frayed or otherwise damaged.***
- ***To avoid hazardous electric shock or laser radiation exposure, do not remove any covers or screws other than those specified in this manual.***
- ***Turn off the power and disconnect the power plug (by pulling the plug, not the cable) if any of the following conditions exists:***
 - ***You spill something into the equipment.***
 - ***You suspect that your equipment needs service or repair.***
 - ***Your equipment's cover has been damaged.***
- ***Do not incinerate spilled toner or used toner. Toner dust might ignite when exposed to an open flame.***
- ***Disposal can take place at our authorized dealer or at appropriate collection sites.***
- ***Dispose of the used toner bottle in accordance with the local regulation.***

⚠ CAUTION:

- *Protect the equipment from dampness or wet weather, such as rain, snow, and so on.*
- *Unplug the power cord from the wall outlet before you move the equipment. While moving the equipment, you should take care that the power cord will not be damaged under the equipment.*
- *When you disconnect the power plug from the wall outlet, always pull the plug (not the cable).*
- *Do not allow paper clips, staples, or other small metallic objects to fall inside the equipment.*
- *Keep toner (used or unused) and toner bottle out of the reach of children.*
- *For environmental reasons, do not dispose of the equipment or expended supply waste at household waste collection points. Disposal can take place at an authorized dealer or at appropriate collection sites.*
- *The inside of the machine could be very hot. Do not touch the parts with a label indicating the “hot surface”. Otherwise it could cause a personal burn.*
- *Our products are engineered to meet high standards of quality and functionality, and we recommend that you only use the expendable supplies available at an authorized dealer.*

How to Read this Manual

Symbols

In this manual, the following symbols are used:

 **WARNING:**

This symbol indicates a potentially hazardous situation that might result in death or serious injury when you misuse the machine without following the instructions under this symbol. Be sure to read the instructions, all of which are included in the Safety Information section.

 **CAUTION:**

This symbol indicates a potentially hazardous situation that might result in minor or moderate injury or property damage that does not involve personal injury when you misuse the machine without following the instructions under this symbol. Be sure to read the instructions, all of which are included in the Safety Information section.

- WARNINGS and CAUTIONS are notes for your safety.

 **Important**

If this instruction is not followed, paper might be misfeed, originals might be damaged, or data might be lost. Be sure to read this.

 **Preparation**

This symbol indicates the prior knowledge or preparations required before operating.

 **Note**

This symbol indicates precautions for operation or actions to take after misoperation.

 **Limitation**

This symbol indicates numerical limits, functions that cannot be used together, or conditions in which a particular function cannot be used.

 **Reference**

This symbol indicates a reference.

[]

Keys that appear on the machine's display panel.

[]

Keys built into the machine's control panel.

TABLE OF CONTENTS

What You Can Do with this Machine (Copy Mode)	2
Guide to Components	4
Options	6
Control Panel	7
Display Panel	9
Common Displays and Keys.....	9

1. Basics

Starting the Machine	13
Turning On the Main Power.....	13
Starting the Machine.....	14
Shutting Down the Machine.....	14
Turning Off the Main Power.....	14
Originals	15
Sizes and Weights of Recommended Originals.....	15
Sizes Detectable by Auto Paper Select.....	16
Scannable Area from the Exposure Glass.....	17
Copy Paper	18
Recommended Paper Sizes and Types.....	18
Non-recommended Paper.....	20
Paper Storage.....	20
Toner	21
Handling Toner.....	21
Toner Storage.....	21
Used Toner.....	21

2. Copying

Basic Procedure	23
Setting Originals	26
Setting Originals on the Exposure Glass.....	26
Setting Originals in the Document Feeder.....	27
Original Orientation.....	28
Setting Special Originals.....	31
Basic Functions	34
Adjusting Copy Image Density.....	34
Choosing the Original Type.....	36
Selecting Copy Paper.....	37
Auto Reduce/Enlarge.....	40
Copying onto OHP Transparencies.....	41
Copying onto Tab Stock.....	42
Sort	44

To stop scanning temporarily	45
If memory reaches 0 %	45
Stack	47
Staple	49
Punch	52
Programs	55
Storing a Program	55
Changing Stored Program	57
Deleting a Program	58
Recalling a Program.....	59
Job Preset	60
Editing Job Preset	61
Changing the Order of the Job Preset	64
Deleting Job Preset.....	66
Other Functions	68
Energy Saver Mode	68
Interrupt Copy	68
User Codes	70
Auto Start	70
Original Tone.....	71
Sample Copy.....	71
Preset Reduce/Enlarge	72
Zoom	75
Size Magnification	77
Directional Magnification (%)	79
Directional Size Magnification (inch)	82
Duplex	84
1 Sided → 2 Sided	84
2 Sided → 2 Sided	88
Combine	90
1 Sided 2 Pages → Combine 1 Side.....	92
1 Sided 4 Pages → Combine 1 Side.....	94
1 Sided 8 Pages → Combine 1 Side.....	95
1 Sided 4 Pages → Combine 2 Side.....	97
1 Sided 8 Pages → Combine 2 Side.....	99
1 Sided 16 Pages → Combine 2 Side.....	101
2 Sided 1 Page → Combine 1 Side	103
2 Sided 2 Pages → Combine 1 Side.....	105
2 Sided 4 Pages → Combine 1 Side.....	107
2 Sided 2 Pages → Combine 2 Side.....	109
2 Sided 4 Pages → Combine 2 Side.....	111
2 Sided 8 Pages → Combine 2 Side.....	113
Series Copies	116
2 Sided→1 Sided	116

Book → 1 Sided	118
Copying Book Originals.....	120
Book→2 Sided	120
Multi → 2 Sided.....	123
Booklet	125
Magazine.....	127
Margin Adjustment.....	130
Border Erase.....	132
Center/Border Erase.....	135
Delete Area.....	138
Delete Inside	138
Delete Outside	140
Additional.....	142
3 Side Full Bleed	142
Double Copies.....	143
Image Repeat.....	145
Centering.....	146
Front Cover	149
Back Covers.....	151
Designate/Chapters.....	153
Designate: Copy.....	154
Designate: Blank.....	156
Chapters.....	158
Slip Sheet Copy	160
Slip Sheets	163
Background Numbering.....	165
Preset Stamp.....	167
User Stamp.....	171
Program/Delete User Stamp	174
Date Stamp.....	180
Page Numbering.....	183
Choosing How Copies Are Delivered	190
Shift Tray Off In Sort/Stack	190
Separation.....	191
Copy Face Up	192
Combination Chart	193

3. Document Server

Overview.....	195
Document Server Features	195
Document Server Editor Features.....	196

Features and Benefits	197
On Demand Printing	197
Scanned File Printing	198
Scanning Originals	199
Printing Saved Documents	204
Sample Printing.....	209
Print First Page	210
Changing File Names	211
Merging Documents	214
Inserting Files	217
Deleting Pages	220
Deleting Saved Documents	224
Deleting Saved Documents in HDD	224
Deleting Saved Documents on the CD-ROM.....	226
Moving/Copying Files	229
Moving/Copying files from HDD to CD-ROM	229
Moving/Copying files from CD-ROM to HDD	234

4. Connect Copy (Option)

What is Connect Copy?	239
How Connect Copy Works	241
Connectable Copier Models	241
Functions Not Available with Connect Copy	242
Interrupt Functions	242
Before You Start.....	242
Connect Copy Display Panel	243
Using Connect Copy	246
Exiting Connect Copy Mode.....	251
Relationship between Master Unit and Sub-unit System Settings ...	252
Relationship between Master Unit and Sub-Unit Copier/ Document Server Features	255

5. What to do if Something Goes Wrong

If Your Machine Does Not Operate as You Want	261
General	261
Display	265
If Connect Copy is Cleared	268
If You Cannot Exit Connect Copy	269
If You Cannot Make Clear Copies	271
If You Cannot Make Copies As You Want	272
Adjust Image	272

Combine	273
Duplex	274
Stamp	275
Document Server	275
Connect Copy	276
When Memory is Full	276
📄 Loading Paper.....	277
To load paper in tray 1 (Tandem Tray)	277
Loading paper in Tray 2 or 3	279
Loading Paper in the Large Capacity Tray.....	280
Loading Paper in the Optional A3/11" × 17" Tray Kit	281
🔧 Changing the Toner Bottle	283
🧹 Clearing Misfeeds.....	286
Changing the Paper Size	294
Changing the paper size in Tray 1	294
Changing the paper size in Tray 2 and Tray 3	294
Changing The Paper Size Of The Optional Large Capacity Tray (Tray 4 and Tray 5).....	296
Changing The Paper Size Of The Optional Large Capacity Tray (Tray 6)...	298
📄 Adding Staples	299
🔧 Removing Jammed Staples.....	302
🗑️ Removing Punch Waste.....	305

6. User Tools (Copier/Document Server Features)

Accessing User Tools (Copier/Document Server Features)	307
Exiting User Tools	309
User Tools Menu (Copier/Document Server Features).....	310
Settings You Can Change with the User Tools	312
General Features	312
Adjust Image	318
Stamp	323
Input/Output.....	328
Document Server.....	330
Key Operator Tools	331

7. REMARKS

Do's And Don'ts.....	333
Where to Put Your Machine.....	334
Machine Environment	334
Power Connection	335
Access to Machine	336
Maintaining Your Machine	337

Cleaning the Exposure Glass.....	337
Cleaning the Document Feeder	337
Stapling Position	338

8. Specification

Mainframe.....	339
Document Feeder	343
Finisher.....	344
CD-RW (Option)	345
A3/11" × 17" Tray Kit (Option)	346
Punch Kit (Option).....	347
Large Capacity Tray (LCT) (Option).....	348
Copy Connector Cable (Option).....	349
INDEX.....	350

This page is intentionally blank.

What You Can Do with this Machine (Copy Mode)

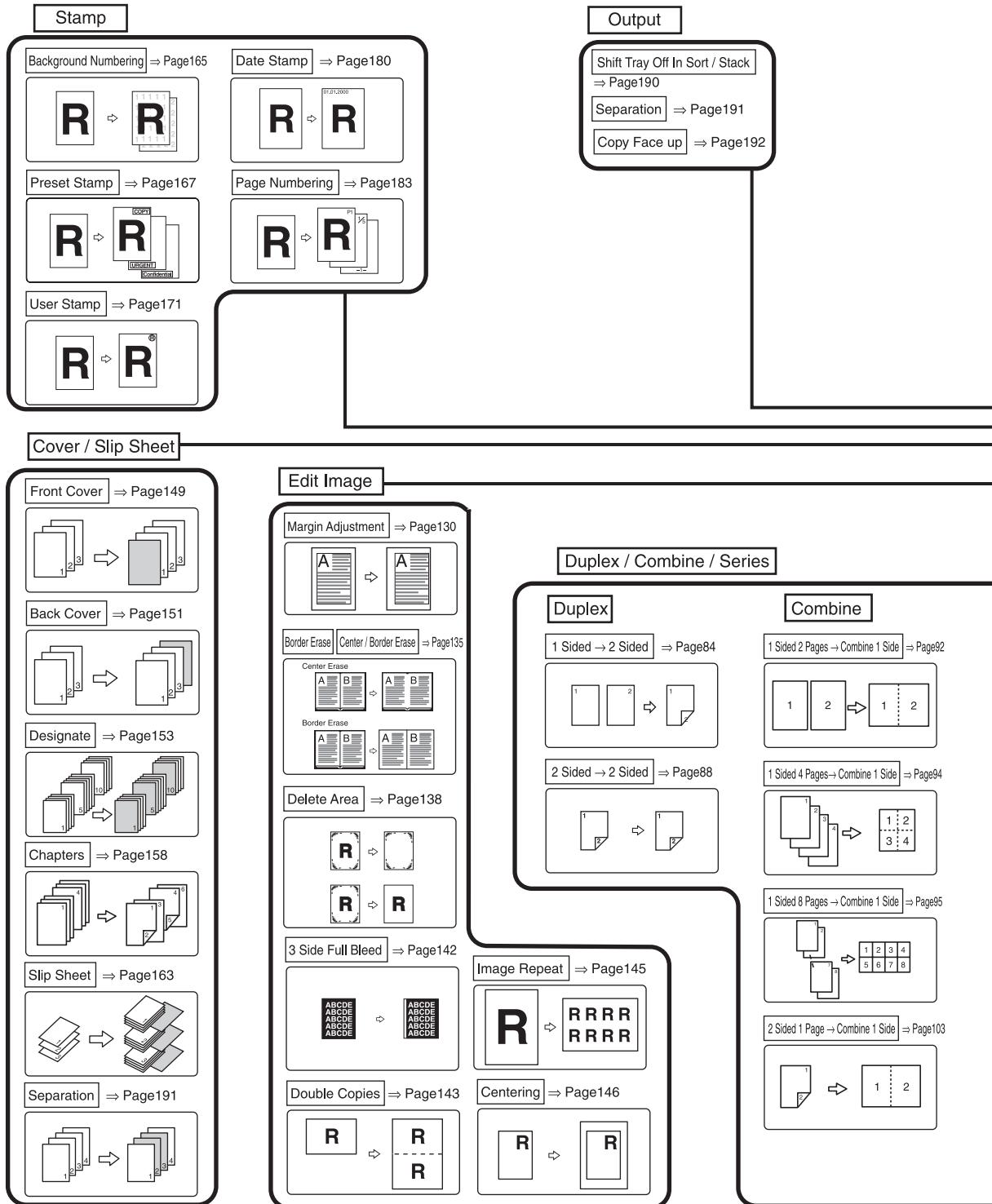

*1 Optional Punch kit required.

Sort	Stack	Staple	Punch
Sort ⇒ Page44 	Stack ⇒ Page47 	Staple ⇒ Page49 	Punch ⇒ Page52 *1

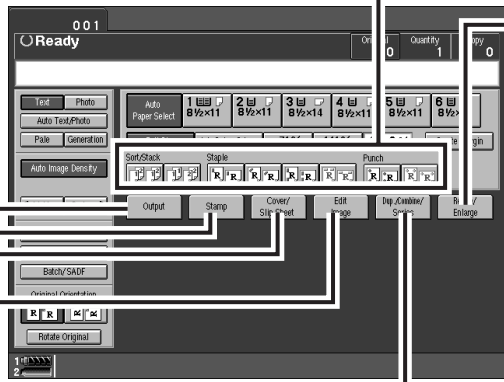

Reduce / Enlarge

Preset Reduce / Enlarge ⇒ Page72
Zoom ⇒ Page75
Size Magnification ⇒ Page77
Directional Magnification(%) ⇒ Page79
Directional Size Magnification(inch) ⇒ Page82

Series

Book → 1Sided ⇒ Page118
2Sided → 1Sided ⇒ Page116

Book

Book → 2Sided ⇒ Page120
Multi → 2Sided ⇒ Page123
Booklet ⇒ Page125
Magazine ⇒ Page127

2 Sided 2 Pages → Combine 1 Side ⇒ Page105 	1 Sided 16 Pages → Combine 2 Side ⇒ Page101
2 Sided 4 Pages → Combine 1 Side ⇒ Page107 	2 Sided 2 Pages → Combine 2 Side ⇒ Page109
1 Sided 4 Pages → Combine 2 Side ⇒ Page97 	2 Sided 4 Pages → Combine 2 Side ⇒ Page111
1 Sided 8 Pages → Combine 2 Side ⇒ Page99 	2 Sided 8 Pages → Combine 2 Side ⇒ Page113

Guide to Components

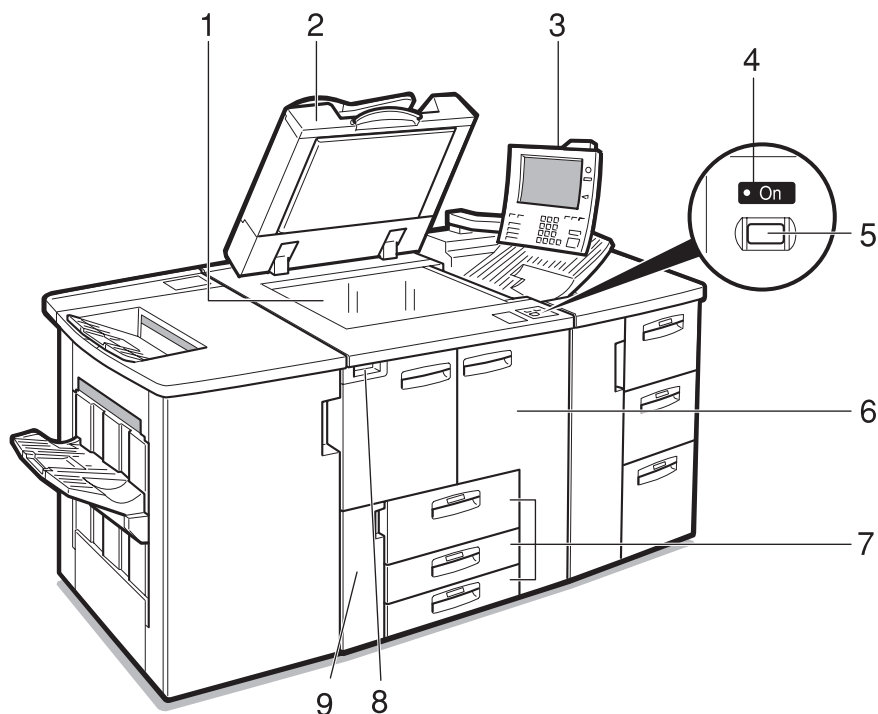

ZAKH020N

1. Exposure glass

Position single-page originals here face down for copying. See ⇒ P.15 "Originals".

2. Document feeder (ARDF)

The document feeder automatically feeds a stack of originals one by one.

3. Control panel

See ⇒ P.7 "Control Panel".

4. On indicator

This indicator lights after you press the operation switch.

5. Operation switch

Press this switch when you wish to use the machine. The On indicator lights when this switch is pressed.

6. Front cover

Open to remove misfed paper.

7. Paper tray

Set copy paper here.

Tray 1 is a tandem tray where the paper on the left side automatically moves to the right when paper on the right has run out. See ⇒ P.277 "Loading Paper".

8. Main power switch

Press to turn the main power on or off. We recommend you only turn this switch off when the machine is not going to be used for an extended period of time (e.g. over a vacation).

Note

- If the On indicator does not light when you press the operation switch, make sure the main power switch is set to on.

9. Toner cover

Open to change the toner bottle.

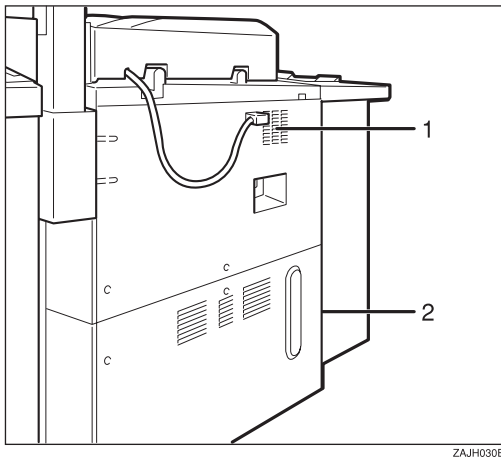

1. Ventilation hole

Prevents overheating. Do not obstruct the ventilation hole by placing or leaning an object near it. If the machine overheats, a fault might occur.

2. Circuit breaker

Do not touch this breaker.

Options

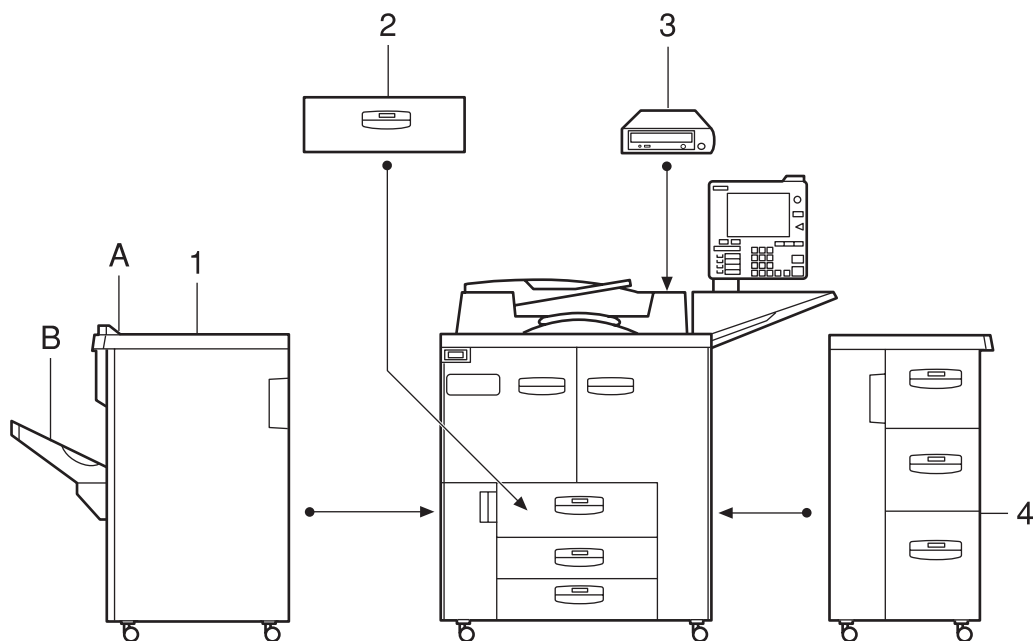

ZAJP550E

1. Finisher

Sorts, stacks, staples and punches copies (optional punch kit required.)

- A: Finisher proof tray
- B: Finisher shift tray

2. A3/11" × 17" Tray Kit

Holds A3/11" × 17" size papers.



Note

- If you install the A3/11" × 17" Tray kit to your machine, you cannot use it as a tandem tray.

3. CD-RW

Store your documents.

4. Large Capacity Tray (LCT)

Holds 4,550 sheets of paper.

Other options:

- Punch kit
- Connect Copy cable

Control Panel

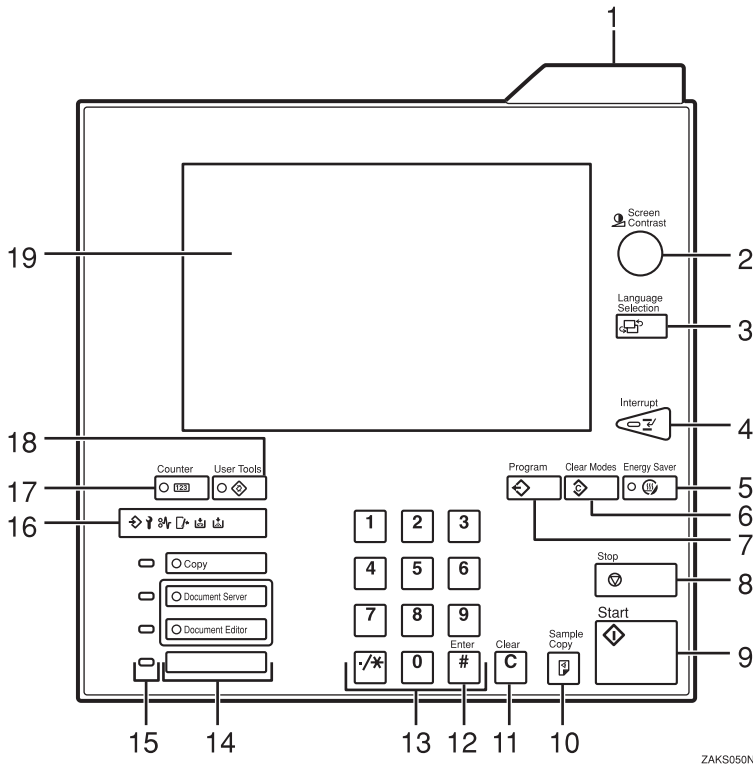

ZAKS050N

1. Status indicator

Color	Status
Off	Ready to make copies
Flashing green	Scanning originals
Lit green	Copying (You can scan originals.)
Flashing red	Toner has nearly run out

2. [Screen Contrast] knob

Adjusts the brightness of the display panel.

3. [Language Selection] key

Press to change the display language.

4. [Interrupt] key

Press to make interrupt copies during a copy run. See ⇒ P.68 "Interrupt Copy".

5. [Energy Saver] key

Press to switch to and from Energy Saver mode. See ⇒ P.68 "Energy Saver Mode".

6. [Clear Modes] key

Press to clear any previously entered copy job settings.

7. [Program] key

Press to register or recall a program. See ⇒ P.55 "Programs".

8. [Stop] key

Press to stop a copy job in progress.

9. [Start] key

Press to start copying. If pressed just after the machine is turned on, the job will start after the warm-up period. See ⇒ P.70 "Auto Start".

10. [Sample Copy] key

Use this key to make a single sample copy set before starting a long copy run.

By checking the finished set and making any necessary changes to the image quality settings before you make multiple copies, you can save time and paper. See ⇒ P.71 “*Sample Copy*”.

11. **[Clear] key**

Press to delete a number entered.

12. **[#] key**

Press to enter a value or confirm a setting.

13. **Number keys**

Use to enter the number of copies you wish to make. Also use to enter values for various features.

14. **Feature keys**

Press the appropriate key to choose any of the following features:

- Copier
- Document Server
- Document Server Editor

15. **Application Status indicators**

These show the status of the above features:

- Green: the feature is active.
- Red: the feature has been interrupted.

16. **Indicators**

These indicators show errors or the status of the machine.

See ⇒ P.261 “*What to do if Something Goes Wrong*”.

17. **[Counter] key**

Press to check the total number of copies made.

18. **[User Tools] key**

Press to access the User Tools menu where you can customize the default settings to your preference.

19. **Display panel**

Shows operation status, error messages, and function menus. See ⇒ P.9 “*Display Panel*”.

Note

- You can adjust the angle of control panel.

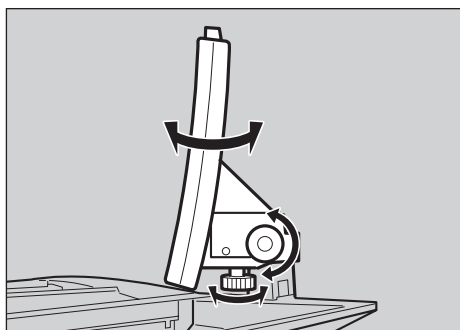
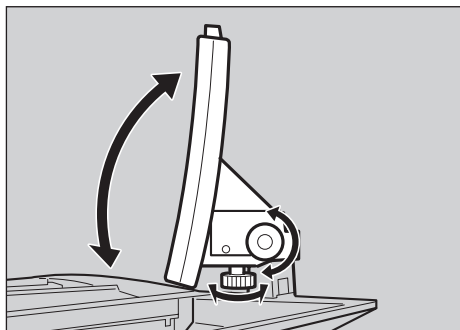

Display Panel

The display panel shows the status of the machine, error messages and function menus.

To select items shown on the display, lightly press the item with your finger. When an item is selected, it is highlighted e.g. **Full Size**. Items that are not available are shown grayed out e.g. **OK**.

Important

- Do not apply a strong shock or force of more than about 30 N (about 3 kgf) to the display panel or it may be damaged.

Common Displays and Keys

Note

- The following example illustrations show the machine with the finisher unit and Large Capacity Tray (LCT) installed.

Initial Copy Display

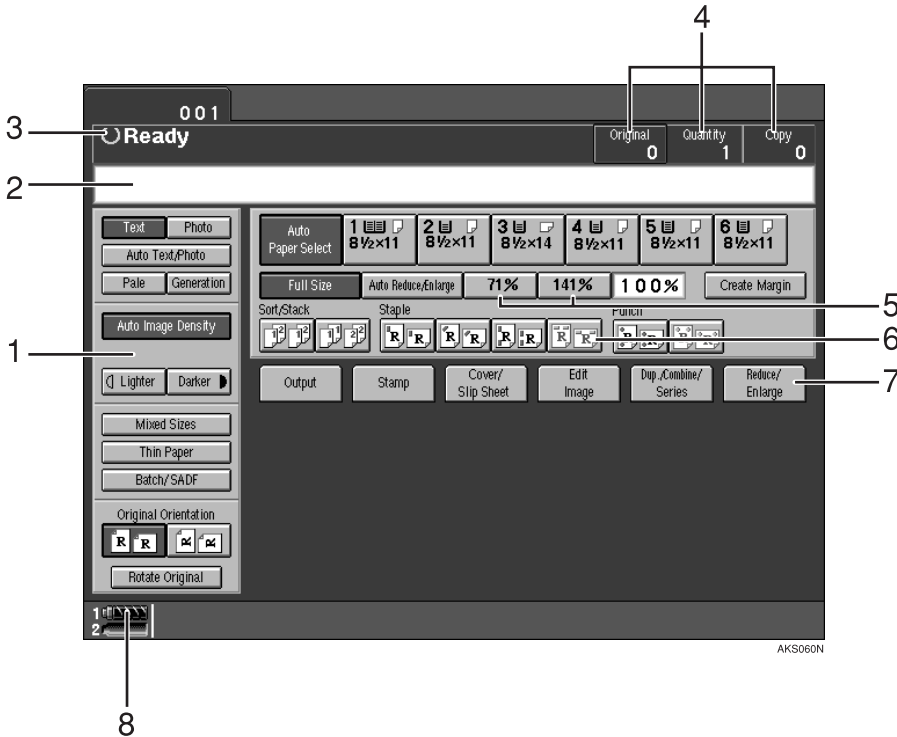

1. Original mode, Image Density and Special Original mode.
2. Operational messages.
3. Operational status.

4. The number of originals scanned into memory, number of copies set, and number of copies made.
5. You can register up to two frequently used reduction/enlargement ratios other than the fixed reduction/enlargement ratios.

6. Sort, Stack, Staple or Punch mode.

7. Functions you can select. Press an item to bring up its function menu

e.g. press the [Reduce/Enlarge] key to bring up the Reduce/Enlarge menu.

8. This indicator shows when toner has nearly run out.

❖ Function Menu

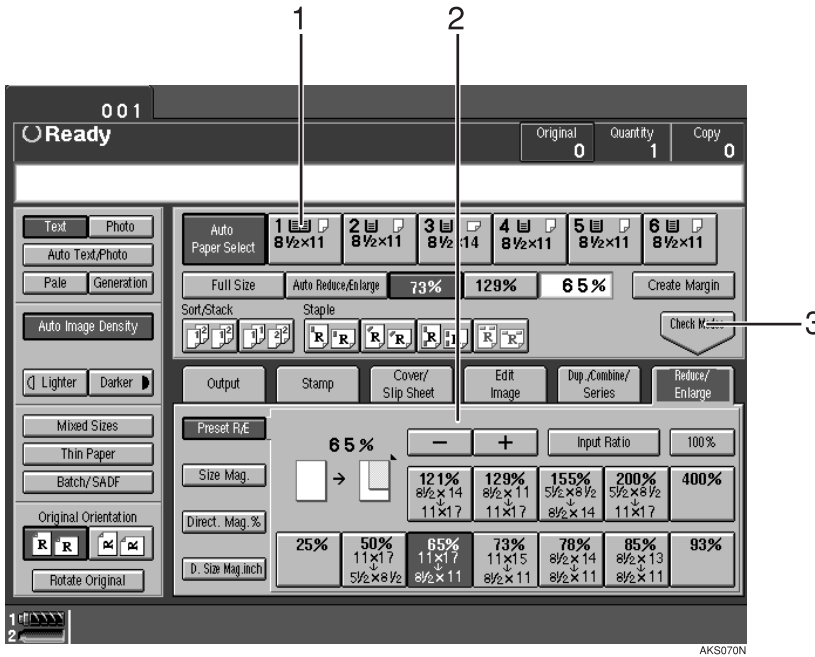

1. The currently selected paper tray is shown highlighted.

2. Items you can select.

3. The [Check Modes] key appears when you have selected one or more functions. Press this key to view the functions currently selected.

❖ Copy Server Display

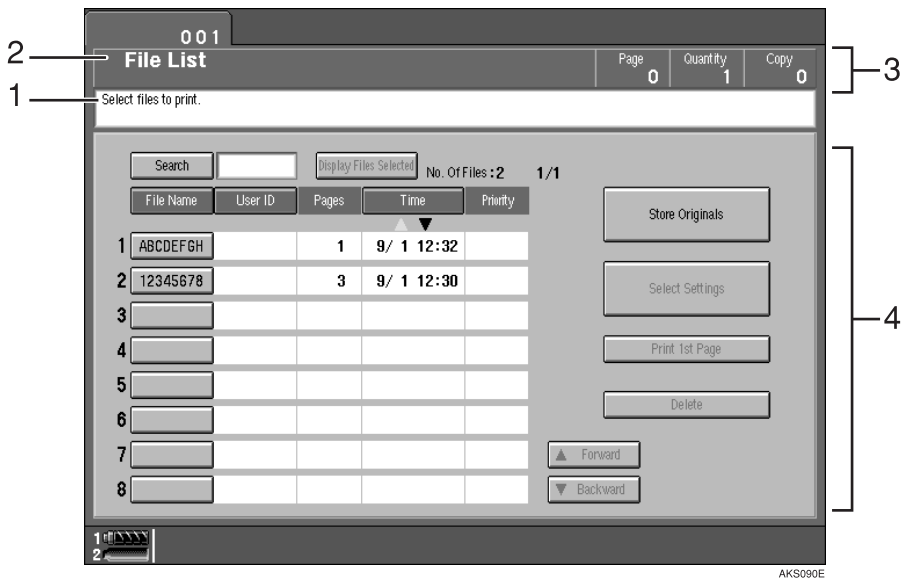

1. Operational messages.

2. Display titles.

3. The number of originals scanned into memory, number of copies set, and number of copies made.

4. Operational keys.

Starting the Machine

To turn the machine on, press the operation switch.

Note

- ❑ This machine automatically enters Energy Saver mode or turns itself off if you do not use the machine for a while. Please refer to “Energy Saver Mode—Saving Energy” and “Auto Off Timer” in the System Settings manual.

Power Switches

This machine has two power switches:

- ❖ **Operation switch (right front side of the document feeder)**
Press this switch when you wish to use the machine. When the machine has warmed up, you can make copies.
- ❖ **Main power switch (left side of the machine)**
Turn off the main power switch when the machine is not to be used for an extended period of time.

Turning On the Main Power

- 1** Make sure that the power cord is plugged firmly into the wall outlet.
- 2** Turn on the main power switch.
Main power indicator lights up.

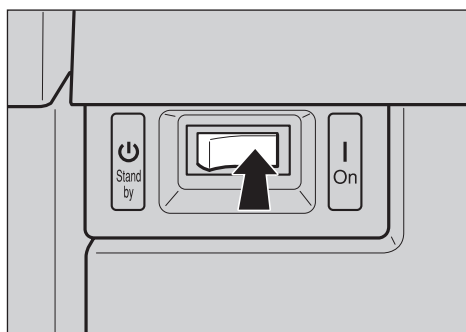

ZAKH010N

Starting the Machine

1 Press the operation switch.

The **On** indicator lights and the display turns on.

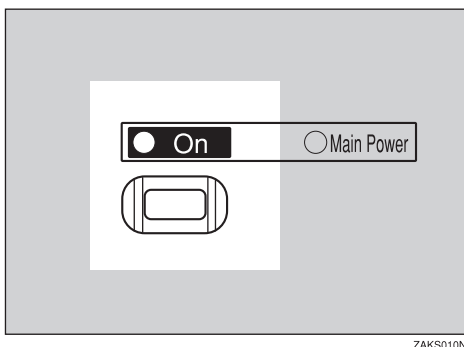

Note

- If the machine does not start when the operation switch is pressed, make sure the main power switch is on.
- The machine will take up to 360 seconds to warm up during which copying is not possible. However, you can set up a job during this period with the Auto Start function. See ⇒ P.70 "Auto Start".
- You can set up a copy job and press the **[Start]** key while the "Select copy mode and press Start. Copying will start after warm up." message is displayed.
- When "Enter user code, then press # key." is displayed, enter your user code. See ⇒ P.70 "User Codes".

Shutting Down the Machine

1 Press the operation switch.

The **On** indicator goes out.

Turning Off the Main Power

1 Press the Main Power switch.

The Main Power switch indicator goes out.

Note









- If you leave the Main Power switch off for more than 20 days, the date setting might be wrong. For how to set the date, see "Timer Settings" in the System Settings manual.

Originals









Sizes and Weights of Recommended Originals

1

❖ Metric version

Where Original Is Set	Original Size	Original Weight
Exposure glass	Up to A3	--
Document feeder	1-sided originals: A3  – A5  	52 – 156 g/m ²
	2-sided originals: A3  – A5  	52 – 128 g/m ²
	Thin Paper mode: A3  – A5 	40 – 156 g/m ²

❖ Inch version

Where Original Is Set	Original Size	Original Weight
Exposure glass	Up to 11" × 17"	--
Document feeder	1-sided originals: 11" × 17"  – 5 ¹ / ₂ " × 8 ¹ / ₂ "  	14 – 42 lb. Bond
	2-sided originals: 11" × 17"  – 5 ¹ / ₂ " × 8 ¹ / ₂ "  	14 – 34 lb. Bond
	Thin Paper mode: 11" × 17"  – 5 ¹ / ₂ " × 8 ¹ / ₂ "  	11 – 42 lb. Bond

Non-recommended Originals for the Document Feeder

Setting the following types of originals in the document feeder can cause paper misfeeds or damage to the originals. Set these originals on the exposure glass instead.

- Originals of inappropriate weight or size see above.
- Stapled or clipped originals
- Perforated or torn originals
- Curled, folded, or creased originals
- Pasted originals

- Originals with any kind of coating, such as thermal fax paper, art paper, aluminum foil, carbon paper, or conductive paper
- Originals with perforated lines
- Originals with indexes, tags, or other projecting parts
- Sticky originals, such as translucent paper
- Thin originals with low stiffness
- Bound originals, such as books
- Transparent or translucent originals, such as OHP transparencies or tracing paper

Sizes Difficult to Detect

It is difficult for the machine to automatically detect the sizes of the following types of originals, so select the paper size manually instead.





















- Originals with indexes, tags, or other projecting parts
- Transparent or translucent originals, such as OHP transparencies or tracing paper
- Dark originals with many letters and drawings
- Originals which partially contain solid images
- Originals which have solid images running to their edges
- Originals other than those marked ○ in the table that follows.

Sizes Detectable by Auto Paper Select

❖ Metric version

Size Where Original Is Set	A3	B4	A4	B5	A5	A5	11 " × 17"	11 " × 15"	8 ¹ / ₂ " × 14"	8 ¹ / ₂ " × 11"	5 ¹ / ₂ " × 8 ¹ / ₂ "	5 ¹ / ₂ " × 8 ¹ / ₂ "
Exposure glass	○	○	○	○	○	×	○	○	○	○	○	×
Document feeder	○	○	○	○	○	○	○	○	○	○	○	○

❖ Inch version

Size Where Original Is Set	A3 	B4 	A4  	B5  	A5  	B6  	11"×17" 	11"×15" 	8 ¹ / ₂ "×14"  	8 ¹ / ₂ "×11"  	5 ¹ / ₂ "×8 ¹ / ₂ "  	8 ¹ / ₂ "×13"   ^{*1}
Exposure Glass	×	×	×	×	×	×	○	×	○	○	×	×
Document Feeder	×	×	○	×	×	×	○	○	○	○	○	○

*1 You can select from 8¹/₂" × 13", 8¹/₄" × 13" and 8" × 13" with the User Tools (System Settings). See "Original: F/F4 Size Setting" in the "System Settings" manual.

❖ Exposure glass

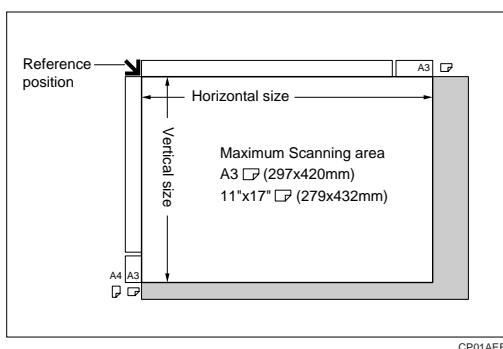

❖ Document feeder

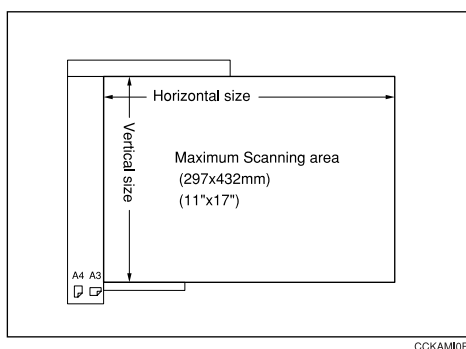

Scannable Area from the Exposure Glass



















































































Even if you correctly set originals in the document feeder or on the exposure glass, 5 mm, 0.2" margins on all four sides might not be copied.

Copy Paper

1

Recommended Paper Sizes and Types

The following limitations apply to each tray:

	Tray	Metric Version	Inch Version	Paper Weight	Paper Capacity
Main Machine	Tray 1 ^{*1} (Tandem tray)	A4  , 8 1/2" × 11" 	A4  , 8 1/2" × 11" 	52 – 163 g/m ² , 16 lb. Bond – 90 lb. Index	1,000 sheets + 1,000 sheets
	Tray 1 ^{*1} (Optional A3/11" × 17" Tray Kit)	A3  , B4  , A4   , 8 1/2" × 11"   , 8 1/2" × 14" 	A3  , B4  , A4   , 8 1/2" × 11"   , 8 1/2" × 14" 	52 – 163 g/m ² , 16 lb. Bond – 90 lb. Index	1,000 sheets
	Tray 2 ^{*2}	A3  A4   , B5   , A5  , 8 1/4" × 13"  , 8 1/2" × 13" 	11" × 17"  , 10" × 14"  , 8 1/2" × 14"  , 8" × 13"  , 8 1/2" × 11"   , 8" × 10 1/2"  , 8" × 10"  , 5 1/2" × 8 1/2"  	52 – 163 g/m ² , 16 lb. Bond – 90 lb. Index	500 sheets
	Tray 3 ^{*2}	A3  A4   , B5   , A5  , 8 1/4" × 13"  , 8 1/2" × 13" 	11" × 17"  , 10" × 14"  , 8 1/2" × 14"  , 8" × 13"  , 8 1/2" × 11"   , 8" × 10 1/2"  , 8" × 10"  , 5 1/2" × 8 1/2"  	52 – 163 g/m ² , 16 lb. Bond – 90 lb. Index	500 sheets
Large Capacity Tray (LCT)	Tray 4, 5 ^{*3} ^{*4}	A4  , A5   , 8 1/2" × 11"  , 5 1/2" × 8 1/2"   , B5 	A4  , A5   , 8 1/2" × 11"  , 5 1/2" × 8 1/2"   , B5 	52 – 216 g/m ² , 16 lb. Bond – 80 lb. Cover	1,000 sheets
	Tray 6 ^{*1} ^{*3} ^{*4}	A4  , A5   , 8 1/2" × 11"  , 5 1/2" × 8 1/2"   , B5 	A4  , A5   , 8 1/2" × 11"  , 5 1/2" × 8 1/2"   , B5 	52 – 163g/m ² , 16 lb. Bond – 90 lb. Index	2,550 sheets

^{*1} The paper tray fence is fixed. If you wish to change the size of paper set in this tray, please contact your service representative.

- *2 If you wish to copy onto non-standard size paper, select the size with User Tools. See “Tray Paper Settings” in the System Settings manual.
- *3 If you wish to copy onto OHP transparencies or thick paper, select OHP or Thick Paper mode. See “Tray Paper Settings” in the System Settings manual.
- *4 When setting copy paper, make sure the stack height does not exceed the limit mark. The maximum number of sheets you can set at once depends on the paper thickness and condition.

Important

- If you use damp or curled paper, a misfeed, staple jam or mis-stapling might occur. Try turning over the paper stack in the paper tray. If there is no improvement, change to copy paper with less curl.
- If you use damp or curled OHP transparencies, a misfeed might occur.
- When you set the Index tabs, use the end fence for Index tabs.

Note

- If you load paper of the same size in two or more trays, the machine automatically shifts to another tray when the tray in use runs out of paper. This function is called Auto Tray Switching. This saves interrupting a copy run to replenish paper even when you make a large number of copies. You can turn off this function. See ⇒ P.37 “Selecting Copy Paper”, “Auto Tray Switching” and “Tray Paper Settings” in the System Settings manual.
- When you want to copy on translucent paper, set the copy paper following illustrations. If do not, paper jam might occur.

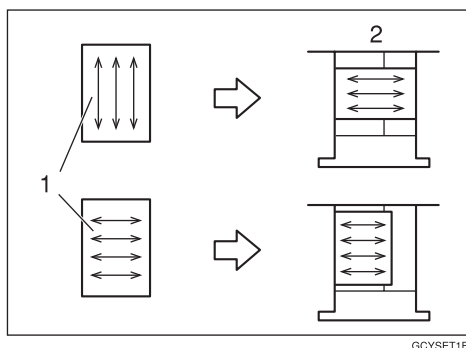

1. Direction of paper grain

2. How to set the copy paper in the paper tray

Limitation

- If you load recycled or special paper in the paper trays and use the Tray Paper Settings in User Tools of the System Settings menu, this function is not available with these trays unless their settings are identical.

Non-recommended Paper

 **CAUTION:**

- *Do not use aluminum foil, carbon paper, or similar conductive paper to avoid a fire or equipment failure.*

 **Important**

- Do not use any of the following kinds of paper or a fault might occur.
 - Thermal fax paper
 - Art paper
 - Aluminum foil
 - Carbon paper
 - Conductive paper
 - Colored OHP transparencies
 - Paper with perforations
 - Paper that has already been copied or printed onto.

 **Note**

- Do not use the following kinds of paper or a misfeed might occur.
 - Bent, folded, or creased paper
 - Torn paper
 - Slippery paper
 - Perforated paper
 - Rough paper
 - Thin paper that has low stiffness
 - Paper coated with a lot of paper dust
- Copying onto rough grain paper can result in a blurred copy image and limited solid fill.

Paper Storage

 **Note**

- When storing paper, the following precautions should always be followed:
 - Do not store paper where it will be exposed to direct sunlight.
 - Avoid storing paper in humid (greater than 70%) areas.
 - Store on a flat surface.
- Keep open reams of paper in the package and store as you would unopened paper. Store on a flat surface.
- Under high or low extremes of temperature/humidity, store paper in a vinyl bag.

Toner

Handling Toner

 **WARNING:**

- *Do not incinerate used toner or toner containers. Toner dust might ignite when exposed to an open flame. Dispose of used toner containers in accordance with local regulations for plastics.*

 **CAUTION:**

- *Keep toner (used or unused) and toner containers out of reach of children.*

 **CAUTION:**

- *Our products are engineered to meet high standards of quality and functionality, and we recommend that you only use the expendable supplies available at an authorized dealer.*

 **Important**

- If you use toner other than the recommended type, a fault might occur.

 **Reference**

For how to change the toner bottle, see ⇒ P.283 “ Changing the Toner Bottle”.

Toner Storage

When storing toner, the following precautions should always be followed:

- Store toner containers in a cool, dry place free from direct sunlight.
- Store on a flat surface.

Used Toner

 **Note**

- Used toner cannot be re-used.

2. Copying

Basic Procedure

- 1 Make sure that the machine is in Copy mode.

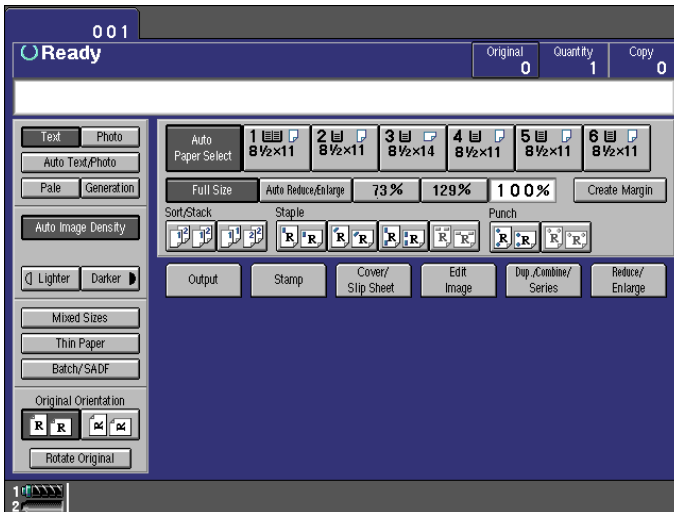

- 2 If user codes are turned on, enter your User Code with the number keys, then press the [#] key.

 Reference

⇒ P.70 "User Codes".

- 3 Make sure that no previous settings remain.

 Note

To clear any previous settings, press the **[Clear Modes]** key.

- 4 Set your originals.

 Reference

⇒ P.26 "Setting Originals".

- 5 Set your desired settings.

6 Enter the number of copies required with the number keys.

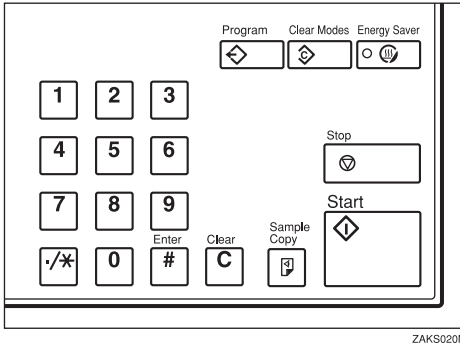

Note

- The maximum copy quantity can be set between 1 and 9999 (default: 9999). See “Maximum Copy Quantity” ⇒ P.312 “General Features”.
- To change the number entered, press the **[Clear]** key and enter the new number.

7 Press the **[Start]** key.

The machine starts copying.

Note

- Usually, when you set a single original on the exposure glass or in the document feeder, the copies are delivered face-up. However, with some functions copies will be delivered face-down.
- You can choose to have copies delivered either face up or face down. See “Face-up/down Eject From Platen” ⇒ P.328 “Input/Output”.
- To stop the machine during a multi-copy run, press the **[Stop]** key.
- To clear these copy job settings and return the machine to the initial condition after copying, press the **[Clear Modes]** key.

Auto Reset

The machine automatically returns to the initial condition a fixed period of time after your job is finished. This function is called “Auto Reset”.

Note

- You can change the Auto Reset delay. See “Copy Reset Timer” ⇒ P.312 “General Features”.

 **Energy Saver**

This indicator lights when the machine is saving energy. To exit Energy Saver mode, press any key on the control panel. ⇒ P.68 “*Energy Saver Mode*”

 **Auto Off**

The machine automatically turns itself off a fixed period of time after your job is finished. This function is called “Auto Off”.

 **Note**

- You can change the Auto Off delay. See “Auto Off Timer” in the System Settings manual.

Setting Originals

⚠ Limitation

- ❑ Set originals after correction fluid and ink has completely dried. Not taking this precaution could mark the exposure glass and cause marks to be copied.

📝 Note

- ❑ Normally originals should be aligned to the rear left corner. However, some copy functions may produce different results depending on the direction of the originals. For details, see the explanations of each function in this manual.

	Original	Exposure glass	Document feeder
Standard			
90° turn			

G0GSET1E

🔍 Reference

See ⇒ P.15 “Originals”.

Setting Originals on the Exposure Glass

1 Lift the document feeder.

📝 Note

- ❑ Be sure to open the document feeder by more than 20° otherwise the original size might not be detected correctly.

- 2** Set the first page of your original face down on the exposure glass and align it to the rear left corner.

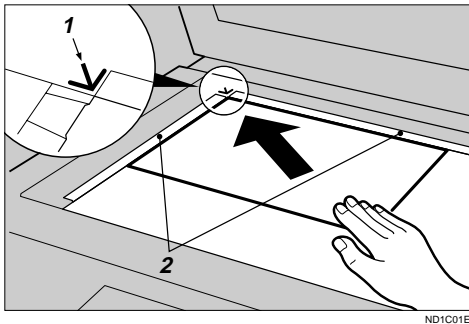

- 1: Reference mark
2: Scale

- 3** Lower the document feeder.

Setting Originals in the Document Feeder

Note

- The last page should be on the bottom.
- Do not stack originals beyond the limit mark on the side fence of the document feeder.
- When copying thin originals (40 – 52 g/m², 11 – 14 lb, Bond), set one page at a time in the document feeder or on the exposure glass to avoid damage due to multi-sheet feeds (several pages fed together at the same time).
- Originals in pencil or other similar media may get slightly smudged after being scanned through the ARDF. To avoid this, you can set them on the exposure glass instead.
- As a rule, one-sided originals are delivered to the ARDF external tray, and two-sided originals to the ARDF tray.

Reference

For originals that the document feeder can handle, see ⇒ P.15 “Originals”.

To set a stack of originals in the document feeder

- 1** Adjust the guide to the original size.

2 Set the aligned originals face up into the document feeder.

Your originals are set correctly when the bottom plate rises.

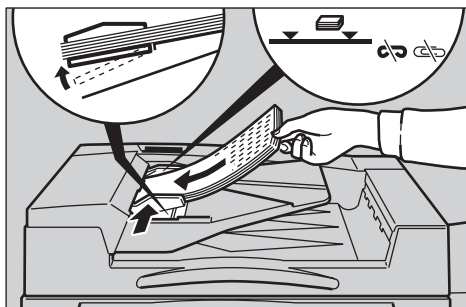

Important

- After the bottom plate of the document feeder rises, do not add or force in originals.

Note

- To avoid a multi-sheet feed, fan the originals before setting them in the document feeder.
- You can set the rise time for the bottom plate of the document feeder. See "ADF Original Table Rise Time" ⇒ P.328 "Input/Output".

Original Orientation

You can set the original orientation separately in the following ways.

This function is useful for copying torn originals or large originals.

❖ Standard Orientation

Use copying for in the standard orientation.

❖ 90° Turn

This function rotates the copy image by 90°.

Use this function when you want to copy onto A3, B4, 11" × 17" paper.

❖ Rotate Original

This function rotates the copy image by 180°.

Standard Orientation

1 Make sure the [Standard Orientation] key is selected.



2

90° Turn

When you want to copy onto A3, B4 or 11" × 17" size originals, set your original in the landscape orientation and then press the 90° Turn key. The machine rotates original image and you can make copies as you wish. This is useful for copying large originals with Staple, Punch, Duplex, Combine or Stamp functions.

For example, if you want to copy A3 or 11" × 17" originals with the Staple function configured it as shown below:

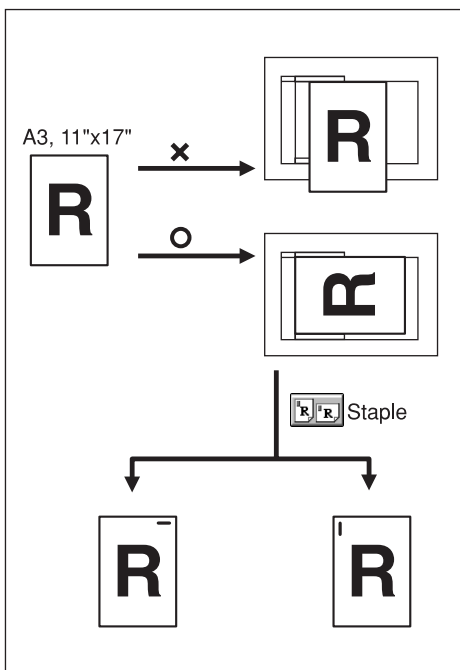

1 Press the [90° Turn] key.



2

Rotate Original

This function rotates the copy image by 180°.

This is useful for copying torn originals. For example, if the left side of the original is damaged, set it as shown below:

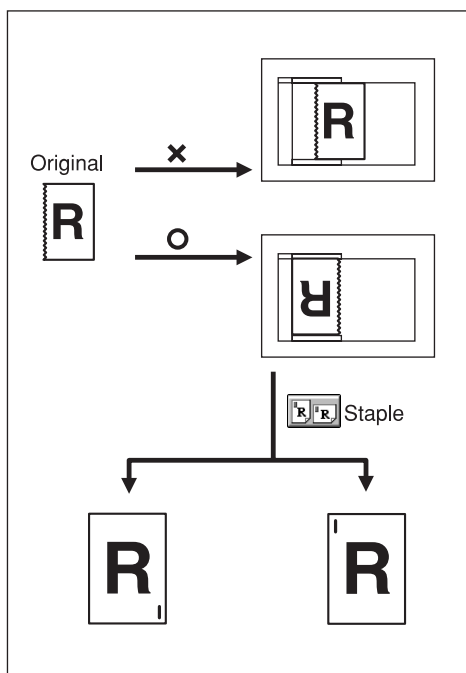

GCGSET3E

1 Press the [Rotate Original] key.

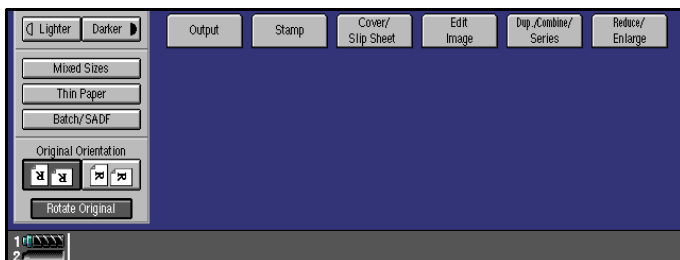

Note

- It is recommended to use this function together with the Auto Paper Select or Preset Reduce/Enlarge function.
- Copy results may differ depending on the combination of selected functions.

Setting Special Originals

2

Mixed Sizes Mode

Use this mode for copying an original that contains pages of different sizes.

If you copy this kind of original from the document feeder using standard copying, some parts of the original images may not appear on copies or misfeeds may occur. However, if you choose Mixed Sizes Mode, the machine automatically checks the size of each original and makes copies accordingly.

Limitation

- Acceptable original weights for this function are in the range 52 – 81 g/m², 14 – 20 lb. Bond.
- Acceptable copy paper sizes for this function are as follows:

Metric version	A3 <input type="checkbox"/> , B4 <input type="checkbox"/> , A4 <input type="checkbox"/> <input type="checkbox"/> , B5 <input type="checkbox"/> <input type="checkbox"/>
Inch version	11" × 17" <input type="checkbox"/> , 8 ¹ / ₂ " × 14" <input type="checkbox"/> , 8 ¹ / ₂ " × 11" <input type="checkbox"/> <input type="checkbox"/> , 5 ¹ / ₂ " × 8 ¹ / ₂ " <input type="checkbox"/> <input type="checkbox"/>

- For smaller originals, the copy image might be skewed since the originals might not be correctly aligned with the original guide.
- If you want to use the Staple function, originals must all be the same width.
- Maximum number of copies you can staple, A4-100 copies, A3-50 copies, A3/A4-50 copies.
- If you want to have copies punched, only use paper sizes supported by the Punch function. If you do not, the machine might stop copying.

1 Press the [Mixed Sizes] key.



2 Align the rear and left edges of the originals as shown in the illustration.

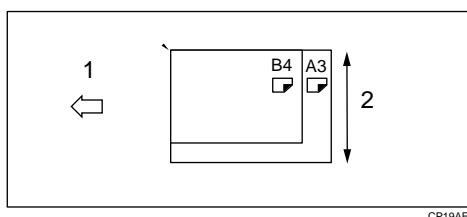

1: Direction in which to set originals in the ARDF.

2: Vertical size

Important

- If the originals are of different vertical sizes, put the longer originals on the bottom otherwise the sizes might not be detected correctly.

3 Adjust the guide to the width of the widest original.

4 Set the aligned originals face up into the document feeder.

Thin Mode

Use Thin mode for copying thin originals from the document feeder.

1 Press the [Thin Paper] key.



Batch/SADF Mode

You can stack up to 100 standard pages in the document feeder. If your original contains more than 100 pages, use this mode to avoid having to press the **[Start]** key after inserting each batch in the document feeder. Once the first 100 pages have been scanned in, just set the next batch of pages and they will be scanned in automatically and copying will continue.

Important

- This mode is also useful when copying special originals that need to be scanned in one page at a time (e.g. translucent paper). Each time you insert a single page into the document feeder, it will be fed automatically.

1 Press the [Batch/SADF] key.

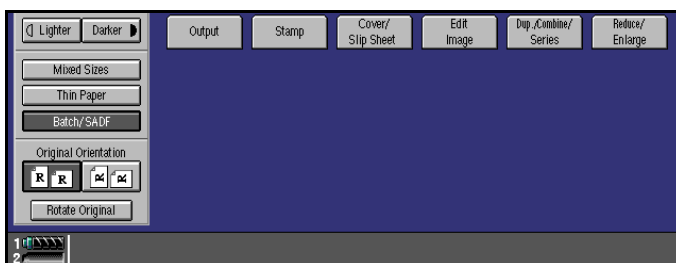

2 Set your originals then press the [Start] key.

The Auto Feed indicator will light.

3 After all the originals have been fed, make sure the Auto Feed indicator is lit then set the next batch of originals.

After setting the second and subsequent batches of originals, you do not have to press the [Start] key.

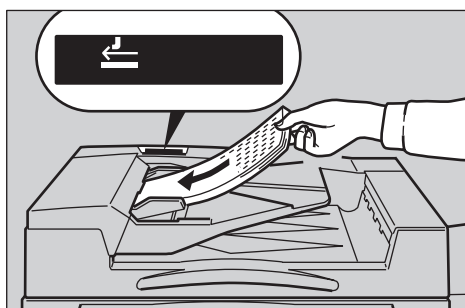

DF02E

Note

- If you are using Sort, Combine or Duplex in conjunction with this function, after all originals have been scanned press the [#] key.
- You can change how long the machine keeps the **Auto Feed** indicator lit so the next batch originals can be set. See "SADF Auto Reset Timer" ⇒ P.328 "Input/Output".

Basic Functions

The following functions are explained in this section:

❖ Copy Image Density

Auto Image Density, Manual Image Density, Combined Auto and Manual Image Density

❖ Original Types

Text, Auto Text/Photo, Photo, Pale, Generation Copy

❖ Copy Paper Select

Auto Paper Select and Manual Paper Select

❖ Auto Reduce/Enlarge

Reduce and Enlarge

Note

- You can choose the default settings for all of the above features. The default setting is the setting that is selected when Auto Reset is activated, Energy Saver mode is exited, or when the machine is powered on. See “General Features” in the System Settings manual or ⇒ P.312 “General Features”.
- You also can change other defaults for these functions. See ⇒ P.312 “Settings You Can Change with the User Tools”.

Adjusting Copy Image Density

The copy image density is the relative brightness or darkness of copies.

There are three ways to select copy image density:

❖ Auto Image Density

The machine automatically chooses a setting to match your original.

❖ Manual Image Density

If you require darker or lighter copies, you may adjust the image density.

❖ Combined Auto and Manual Image Density

Use when copying originals with a dirty background (such as newspapers). You can adjust the foreground density while having the background density selected automatically.

Note

- In Connect Copy mode, make adjustments to copy image density on the master unit.
 - The image density level set on the master unit will be used by both units, However, in order to produce similar images on both units, mark sure the “Original Mode Level” settings are the same on each unit. If they are not the same, the finish of images may differ. ⇒ P.314 “Original Mode Level”

1 Do one of the following:

To have image density selected automatically

- 1 Make sure that the **[Auto Image Density]** key is selected. If it is not selected press the **[Auto Image Density]** key.

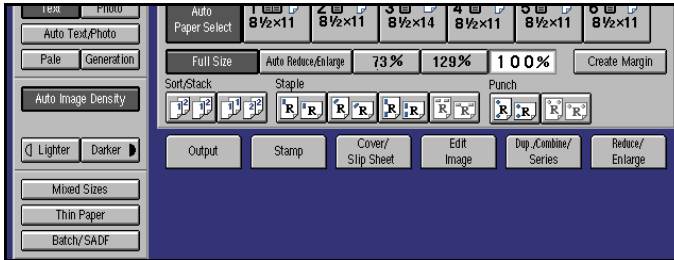

Note

- If the **[Auto Image Density]** key is not selected, press the **[Auto Image Density]** key.
- If you do not wish to set any other functions, press the **[Start]** key to start copying.

To select image density manually

- 1 Press the **[Auto Image Density]** key to deselect Auto Image Density.
- 2 Press the **[Lighter]** or **[Darker]** key to adjust the image density.

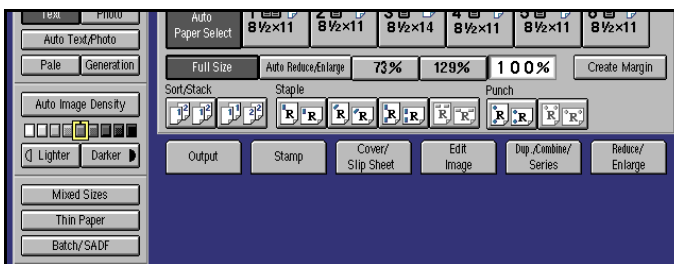

Note

- If you do not wish to set any other functions press the **[Start]** key to start copying.

To combine Auto and Manual Image Density

- 1 Make sure that the **Auto Image Density** is selected.

2 Press the [Lighter] or [Darker] key to adjust the density.

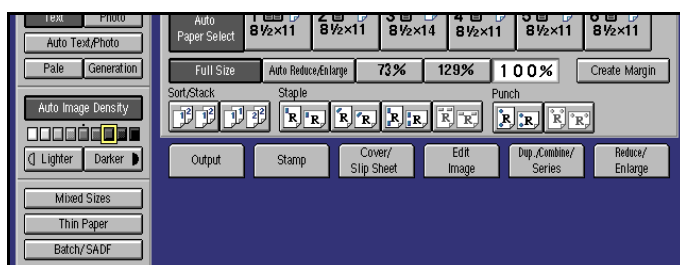

Note

- If you do not wish to set any other functions press the **[Start]** key to start copying.

Choosing the Original Type

The Original Type setting gives you control over the method used to make copies. Choose a type that best matches your original.

The following Original Type settings are available:

❖ Text

Select this mode when your originals contain only letters (no pictures).

❖ Photo

Delicate tones of photographs and pictures can be reproduced with this mode.

❖ Auto Text/Photo

Select Auto Text/Photo when your originals contains photographs or pictures with letters.

❖ Pale

Select this mode for originals that have lighter lines written in pencil, or for carbon copies. The faint lines will be clearly copied.

❖ Generation

If your originals are copies (generation copies), the copy image will be reproduced sharply and clearly.

Note

- You can adjust the quality level for each original type. See “Original Mode Level” ⇒ P.314 “Original Mode Level”.
- You can have the Original Type keys displayed on the initial copy display. See “Original Mode Display” ⇒ P.316 “Display/Panel Tone”.
- Make adjustments to the original type on the master unit.

1 Press the appropriate key to select the original type.

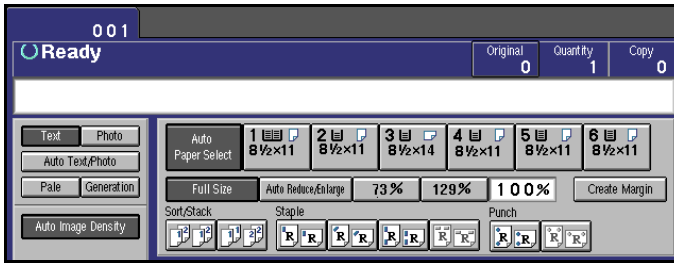

Note

- If you do not wish to set any other functions, press the **[Start]** key to start copying.

Selecting Copy Paper

There are two ways to select copy paper:

❖ Auto Paper Select

The machine selects a suitable size of copy paper automatically based on the original size and the reproduction ratio ⇒ P.39 “Image Rotation”.

❖ Manual Paper Select

Choose the tray containing the paper you wish to copy onto: Paper Tray, Large Capacity Tray (LCT).

Note











- Auto Paper Select mode is intended for normal and recycled paper.
- If you set all the paper trays other than “Plain” or “Recycled Paper”, you cannot use Auto Paper Select.
- Refer to the following table for possible copy paper sizes and directions with Auto Paper Select (when copying at a ratio of 100 %):

❖ Metric version

Where Original Is Set	Paper Size and Direction
Exposure glass	A3 , B4 , A4 , B5 , A5 , 8 ¹ / ₂ " × 13" *1
Document feeder	A3 , B4 , A4 , B5 , A5 , 11" × 17" , 11" × 15" , 8 ¹ / ₂ " × 11" , 8 ¹ / ₂ " × 13" *1

*1 You can select from 8¹/₂" × 13", 8¹/₄" × 13" and 8" × 13" with the User Tools (System Settings). See “Original: F/F4 Size Setting” in the System Settings manual.

❖ Inch version

Where Original Is Set	Paper Size and Direction
Exposure glass	11" × 17"  , 8 1/2" × 14"  , 8 1/2" × 11" 
Document feeder	A4  , 11" × 17"  , 11" × 15"  , 8 1/2" × 14"  , 8 1/2" × 11"  , 5 1/2" × 8 1/2"  , 8 1/2" × 13"  *1

*1 You can select from 8 1/2" × 13", 8 1/4" × 13" and 8" × 13" with the User Tools (System Settings). See "Original: F/F4 Size Setting" in the System Settings manual.

- For some originals, the original size might not be detected correctly. See ⇒ P.16 "Sizes Difficult to Detect".
- When you set recycled paper in the paper tray, you can have the kind of paper shown on the display. See "Tray Paper Settings" in the System Settings manual.

1 Do one of the following

To have the machine select the copy paper automatically

- 1** Make sure that the [Auto Paper Select] key is selected.

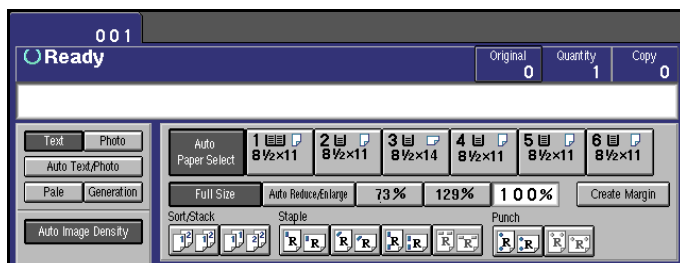

To select the copy paper manually

- 1** Select the paper tray or LCT.

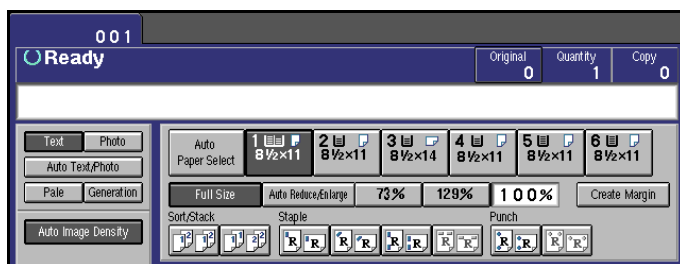
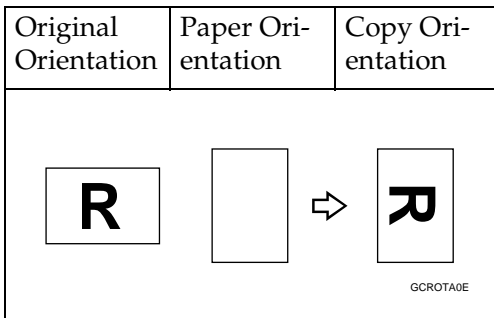





Image Rotation

If the direction in which your original is set (landscape or portrait) is different from the paper you are copying onto, this function rotates the original image by 90° and fits it on the copy paper. This function works when the following functions are selected. Auto paper select, Auto Reduce/Enlarge, See ⇒ P.37 “*Selecting Copy Paper*” and ⇒ P.40 “*Auto Reduce/Enlarge*”.



Limitation

- You cannot use the Image Rotation function with Auto Paper Select if the Auto Tray Switching setting in the User Tools is set to “On (No Rotate)” or “Off”. See “Auto Tray Switching” in the System Settings manual.
- You cannot use the Image Rotation function when enlarging onto B4 or A3 size paper. In this case, set your original in the landscape direction.

	Original Size and Direction			Copy Paper Size and Direction	
You cannot rotate:	A4, B5, or A5 portrait	 GCROTA1E	when enlarging to →	B4, A3	 GCROTA2E
However, you can rotate:	A4, B5, or A5 landscape	 GCROTA3E	when enlarging to →	B4, A3	 GCROTA4E

- You cannot use the Image Rotation function when “Top Slant” or “Top 2” is selected for stapling or if the Punch function is selected. If you try, a “Check paper size and direction” message is displayed. See ⇒ P.49 “*Staple*” and ⇒ P.52 “*Punch*”.

Auto Reduce/Enlarge

The machine can choose an appropriate reproduction ratio based on the paper and original sizes you select.

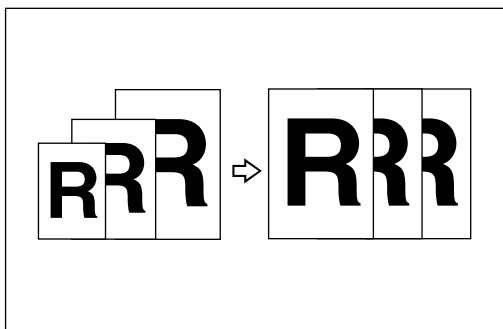

Note

- You can not set papers into the A3/11" × 17" Tray Kit.
- When you use Auto Reduce/Enlarge, refer to the following table for possible original sizes and directions:

❖ Metric version

Where Original Is Set	Original Size and Direction
Exposure glass	A3 ☐, B4 ☐, A4 ☐☐, B5 ☐☐, 8 ¹ / ₂ " × 13" ☐ *1
Document feeder	A3 ☐, B4 ☐, A4 ☐☐, B5 ☐☐, A5 ☐☐, B6 ☐☐, 11" × 17" ☐, 11" × 15" ☐, 8 ¹ / ₂ " × 11" ☐☐, 8 ¹ / ₂ " × 13" ☐ *1

*1 You can select from 8¹/₂" × 13", 8¹/₄" × 13" and 8" × 13" with the User Tools (System Settings). See "Original: F/F4 Size Setting" in the System Settings manual.

❖ Inch version

Where Original Is Set	Original Size and Direction
Exposure glass	11" × 17" ☐, 8 ¹ / ₂ " × 14" ☐, 8 ¹ / ₂ " × 11" ☐☐
Document feeder	A4 ☐☐, 11" × 17" ☐, 11" × 15" ☐, 8 ¹ / ₂ " × 14" ☐, 8 ¹ / ₂ " × 11" ☐☐, 5 ¹ / ₂ " × 8 ¹ / ₂ " ☐☐, 8 ¹ / ₂ " × 13" ☐ *1

*1 You can select from 8¹/₂" × 13", 8¹/₄" × 13" and 8" × 13" with the User Tools (System Settings). See "Original: F/F4 Size Setting" in the System Settings manual.

- The machine can select a ratio in the range 25–400 %.
- For some originals, the original size might not be detected correctly. See ⇒ P.16 "Sizes Difficult to Detect".

- You can set originals of different sizes in the document feeder at the same time. See ⇒ P.31 “Mixed Sizes Mode”.

1 Press the [Auto Reduce/Enlarge] key.

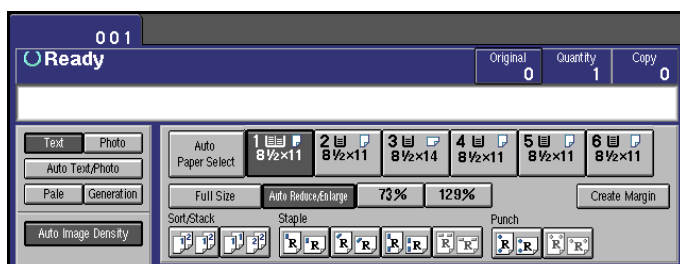

2 Select the paper tray.

Copying onto OHP Transparencies

To make copies onto OHP transparencies, you need to specify the paper type. For details, see “Tray Paper Settings” in the System Settings manual.

1 Open designated OHP tray (Tray2-6).

2 Lightly insert the OHP transparencies face up.

Note

- If you would like slip sheets (blank or copied) between your OHP transparencies, see ⇒ P.163 “Slip Sheets”.
- You cannot set the OHP transparencies into the Tandem Tray or optional A3/11" × 17" Tray Kit.
- To avoid paper misfeeds, fan the OHP transparencies before setting it in the tray.

3 Select the paper tray in which OHP transparencies are loaded.

4 Set your originals then press the [Start] key.

Important

- When copying onto OHP transparencies, remove copied sheets one by one.

Copying onto Tab Stock

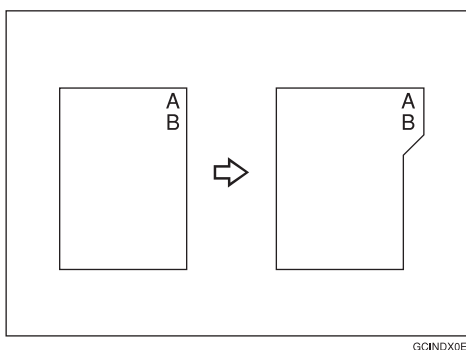

GCINDX0E

Preparation

Set the paper tray for tab stock. See “Tray Paper Settings” in the System Settings manual.

You can set the tab stock in the Large Capacity Tray (LCT) Trays 4 - 5.

Check the position of index tab to avoid the image being sheared. See “Tray Paper Settings” in the System Settings manual.

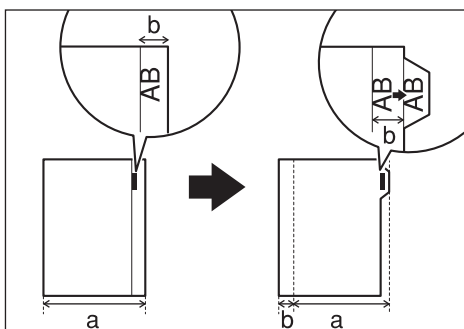

GCINDX1E

Important

- When you set the tab stocks in the tray, always use the end fence.

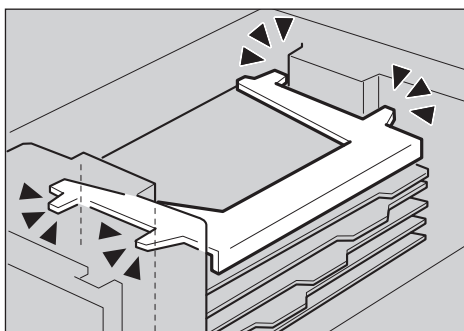

ZAJY530E

- ☐ Tab stocks are always brought from top.

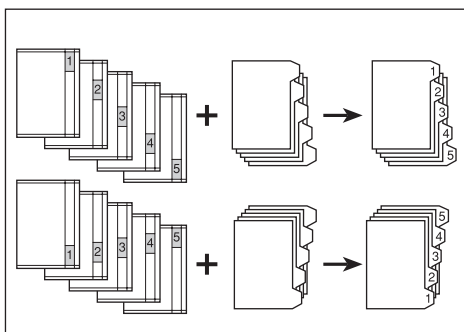

- 1** Select the paper tray in which tab stock are loaded.
- 2** Place your originals and press the **[Start]** key.

Sort

Use this function to have copy sets delivered in order.

Every other copy set is shifted and delivered to the shift tray.

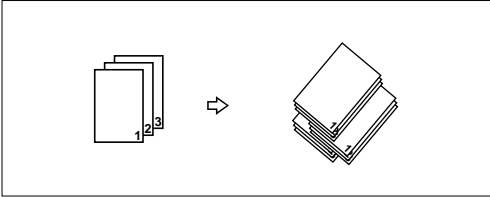

Reference

For the paper capacity of the finisher, see ⇒ P.344 “Finisher”.

Note

- You can select the shift tray on or off in Sort/Stack mode. ⇒ P.190 “Choosing How Copies Are Delivered”

1 Press the [Sort] key.

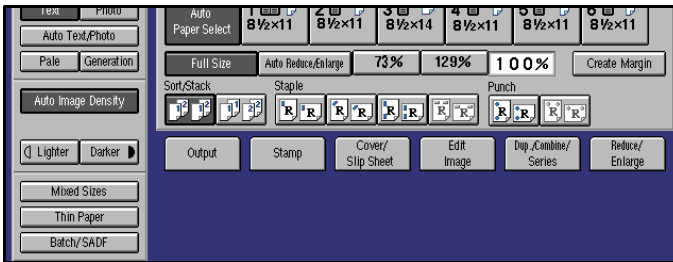

2 Enter the number of copy sets with the number keys.

Limitation

- The maximum number of sets is 9999.

3 Do one of the following:

To set the original in the document feeder

1 Set the stack of originals in the document feeder, then press the [Start] key.

Note

- The last page should be on the bottom.
- If an original is misfeed while sort copying, reset your originals in the document feeder following the instructions on the display. The display will indicate the number of scanned originals.

To set the original on the exposure glass or in the document feeder using Batch/SADF mode

Reference

⇒ P.32 "Batch/SADF Mode".

- 1 Set the first page of your original, then press the **[Start]** key.

Note

- The last page should be on the bottom.

- 2 After it has been scanned in, set the next original then press the **[Start]** key.

Note

- Set the original in the same direction as the first one.

- 3 After all originals have been scanned in, press the **[#]** key.

The copies are delivered to the tray.

To stop scanning temporarily

- 1 Press the **[Stop]** key to stop originals being scanned into memory.

To resume scanning

- 1 Press the **[No]** key to resume scanning.

Note

- Scanned images in memory are not cleared.

To stop scanning and clear all scanned images from memory

- 1 Press the **[Yes]** key.

If memory reaches 0 %

Scanning will be stopped if the size of scanned image data exceeds memory capacity.

Note

- There is enough memory to store approximate 1,000 originals of A4, 8¹/₂" × 11" size. The number of originals that can be stored in memory varies depending on the memory settings and original type.

 **Reference**

Scanning will stop when memory reaches 0 % during sorted copying. However, you can change this setting so that all the scanned pages are copied and delivered to the tray first, then the machine automatically continues scanning the remaining originals. See “Memory Full Auto Scan Restart” ⇒ P.328 “Input/Output”.

2

1 Press the **[Start]** key.

The scanned pages are delivered to the tray. Then the image data in memory is cleared.

2 Remove the copies and continue copying by following the instructions on the display.

Stack

This function groups copies of each page in a multi-page original together. Every other page stack is shifted for ease of separation. The finisher shift tray of the finisher provides this function by sliding from side to side.

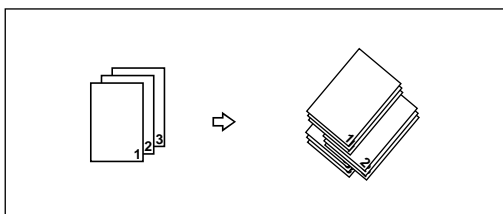

Reference

For the maximum tray capacity of the finisher, see ⇒ P.344 “Finisher”

Note

- You can change shift stack settings with the User Tools. See ⇒ P.190 “Shift Tray Off In Sort/Stack”

1 Press the [Stack] key.

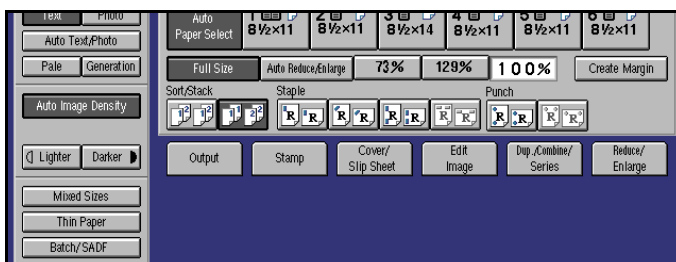

2 Enter the number of copies with the number keys.

3 Set your original in one of the following ways.

To set the original in the document feeder

1 Set a stack of originals in the document feeder, then press the [Start] key.

Note

- The last page should be on the bottom.
- When you use duplex function, the copy paper will be output automatically after all pages are scanned.

To set the original on the exposure glass or in the document feeder using Batch/SADF mode

 **Reference**

See ⇒ P.32 "*Batch/SADF Mode*".

- ① Set the original, then press the **【Start】** key.**

 **Note**

- Start with the first page to be copied.

- ② After it has been scanned in, set the next original then press the **【Start】** key.**

 **Note**

- Set the original in the same direction as the first one.

Staple

Use this function to have each copy set stapled together.

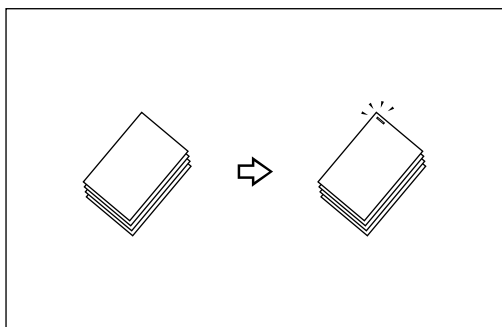

! Limitation

You cannot use the following paper types with this function:

- Tracing paper
- OHP transparencies
- Adhesive labels
- Curled paper
- Low stiffness paper
- Paper of different vertical sizes
- Coated paper

✎ Note

- You can not staple A5 , 5¹/₂" × 8¹/₂" size paper.
- When the number of copies exceeds the shift tray capacity, copying stops. In this case, remove the copies from the finisher shift tray and then resume copying.

Stapler capacity	<ul style="list-style-type: none"> • A4 <input type="checkbox"/>, B5 <input type="checkbox"/>, 8¹/₂" × 11" <input type="checkbox"/>: 2 – 100 sheets (80g/m², 20 lb. Bond) • A3 <input type="checkbox"/>, B4 <input type="checkbox"/>, A4 <input type="checkbox"/>, B5 <input type="checkbox"/> 11" × 17" <input type="checkbox"/>, 8¹/₂" × 14" <input type="checkbox"/>, 8¹/₂" × 11" <input type="checkbox"/>: 2 – 50 sheets (80g/m², 20 lb. Bond)
Shift tray capacity (A4 <input type="checkbox"/> , 8 ¹ / ₂ " × 11" <input type="checkbox"/>) *1	3,000 sheets (80g/m ² , 20 lb. Bond)

*1 Depending on the number of sheets to be stapled and whether sheets have punched holes or not, the maximum tray capacity might be reduced.

- When the number of copies for one set is over the stapler capacity, copies will be delivered to the finisher shift tray unstapled.
- When you select Staple, Sort mode is automatically selected.

- ❑ When the indicator to remove staple waste appears, call your service representative.

Reference

For how to replenish the staple supply, see ⇒ P.299 “ Adding Staples”.

For how to clear staple jams, see ⇒ P.302 “ Removing Jammed Staples”.

2

Stapling Position

When there is copy paper identical in size and direction to your original, the stapling position is see ⇒ P.338 “*Stapling Position*”

Note

- ❑ You cannot change the stapling position during copying.
- ❑ When the original image is rotated, the stapling direction turns by 90°.
- ❑ With “Top” or “Bottom” selected as the stapling position, if no paper is available oriented in the same direction as the original, the image will be rotated and the paper of the same size as the original but oriented in the different direction will be selected.
- ❑ You can select the image on the fourth staple key as “Bottom” or “Top 2”.
- ❑ The maximum original image size that can be rotated is as follows:

Metric version	A4
Inch version	8 ¹ / ₂ " × 11"

- ❑ You cannot use the Image Rotation function when “Top Slant”, “Left 2” or “Top 2” is selected.

1 Select one of the four stapling positions.

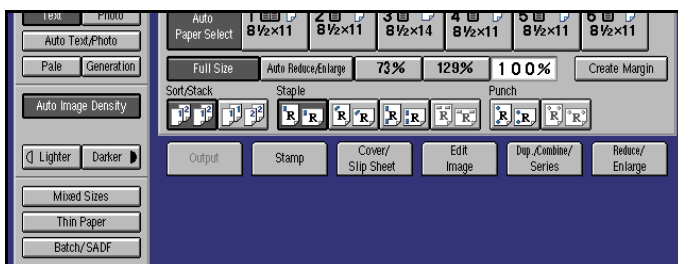

2 Enter the number of copy sets with the number keys.

3 Set your originals in one of the following ways.

To set the original in the document feeder

- ❶ Set a stack of originals in the document feeder, then press the **[Start]** key.

 **Note**

- The last page should be on the bottom.

To set the original on the exposure glass or in the document feeder using Batch/SADF mode

 **Reference**

See ⇒ P.32 “*Batch/SADF Mode*”.

- ❶ **Set the original, then press the **【Start】** key.**

 **Note**

- Start with the first page to be copied.

- ❷ **When it has been scanned in, set the next original, then press the **【Start】** key.**

 **Note**

- Set the original in the same direction as the first one.

- ❸ **After all originals have been scanned, press the **【#】** key.**

The copies are delivered to the tray.

Punch

The optional punch kit is required to use this function.

The function is used to make punch holes in copies.

2

❖ 2 holes

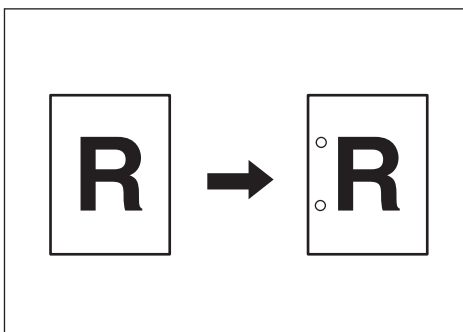

GCPNCH1E

❖ 3 holes

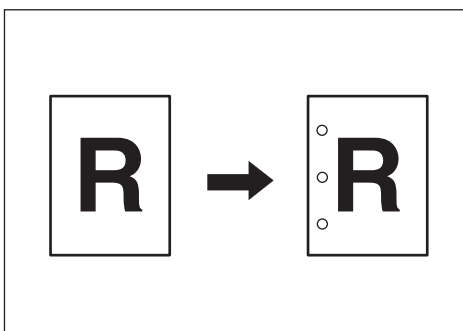

GCPNCH3E

❖ 4 holes

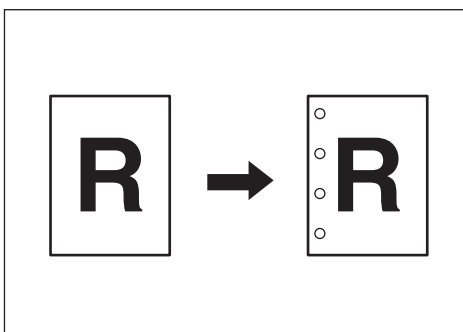

GCPNCH0E

























Limitation

- You cannot use the Image Rotation function if the Punch function is selected. Set your original in the same direction (landscape or portrait) as the copy paper.

Note

- The relationship between the direction in which you set the original and the punch hole positions is as follows:

◆ Punch Hole Positions

	Direction in which Original Is Set		Punch Hole Positions	
		Exposure glass		Document feeder
2 holes				
				
3 holes				
				
4 holes				
				

- Punchable paper sizes are as follows:

Metric version	A3, B4, A4, B5, A5
Inch version	11" × 17", 8 1/2" × 14", 8 1/2" × 11"

- Since punch holes are made in each copy, the punch hole positions vary slightly.
- The punch hole positions change according to the direction of the paper selected.

Reference

If the punch waste box fills up, see ⇒ P.305 “ Removing Punch Waste”.

1 Select the Punch position.

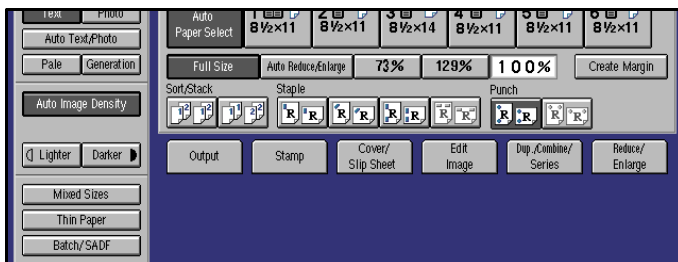

2 Set your originals then press the [Start] key.

2

Programs

You can store frequently used copy job settings in machine memory and recall them for future use.

! Limitation

- You cannot store the settings whether the Connect Copy function will be selected automatically in a program.

✎ Note

- You can store up to 25 programs.
- You can select the standard mode or program No. 25 as the mode to be set when modes are cleared or reset is made, or immediately after the operation switch is turned on. ⇒ P.312 "General Features"
- If you store more than one paper tray of a same size, same orientation, the paper tray prioritized with the program is selected first.
- Programs are not cleared by turning the power off or by pressing the **[Clear Modes]** key. They are canceled only when you delete or overwrite them with another program.
- This function can be used for scanning in copy and document server mode.
- If your program contains settings that are not available in Connect Copy mode, they will be ignored.
- If your program contains settings that are not available on sub-unit, they are ignored.

Storing a Program

1 Edit the copy settings so that all functions you want to store in this program are selected.

2 Press the **[Program]** key.

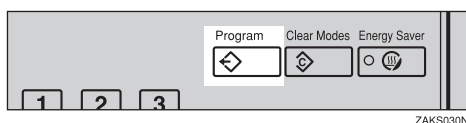

3 Press the [Store] key.

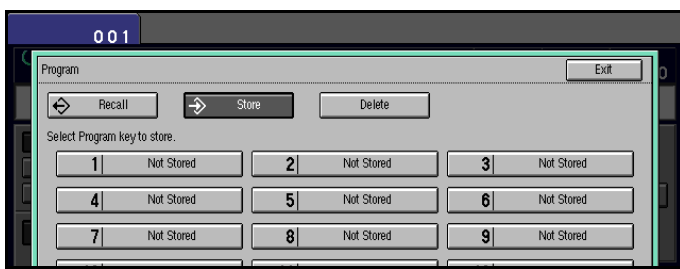

4 Press the program number you want to store.

Note

Program numbers with \Rightarrow already have settings in them. \Rightarrow P.57 "Changing Stored Program"

5 Enter the program name with the letter keys on the display panel. Then press the [#] key.

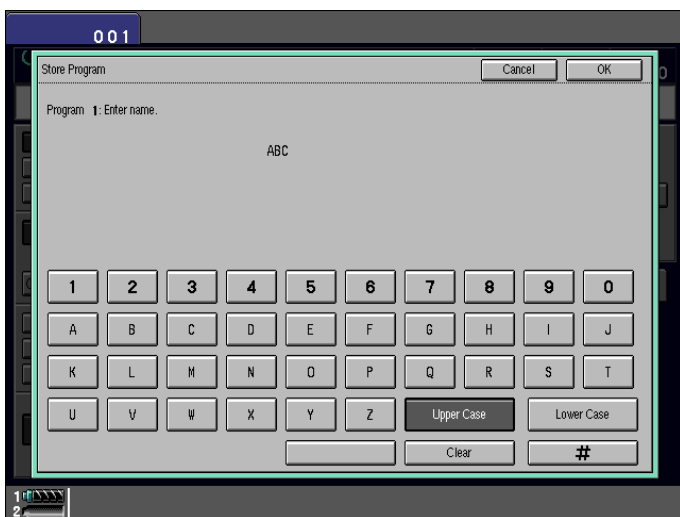

Note

- You can register up to 18 characters.
- To change the name entered, press the [Clear] key and enter new letter.

6 Press the [OK] key.

When the settings are successfully stored, the \Rightarrow indicator appears.

Changing Stored Program

- 1 Press the stored program number key and make sure the settings.

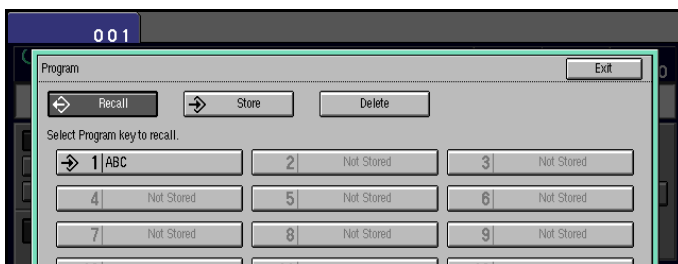

Note

- When you want to check the contents of the program, recall the program.
See ⇒ P.59 "Recalling a Program"

- 2 Repeat the steps 1 and 4 in Storing a Program.

To overwrite the program

- 1 Press the [Yes] key.

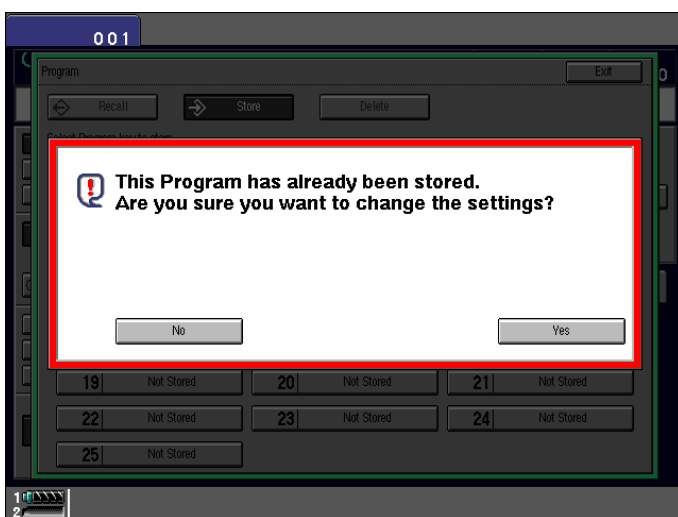

Important

- If you select [Yes], the previous program is lost.
- 2 Enter the program name with the letter keys on the display panel, then press the [OK] key.

Do not to overwrite the program

- 1 Press the [No] key.

Deleting a Program

1 Press the **[Program]** key.

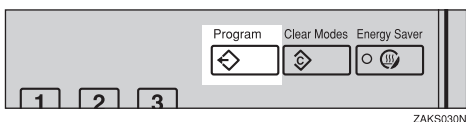

2 Press the **[Delete]** key.

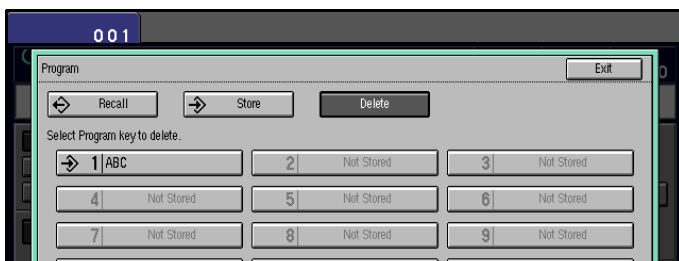

3 Press the program number you want to delete.

4 Press the **[Yes]** key.

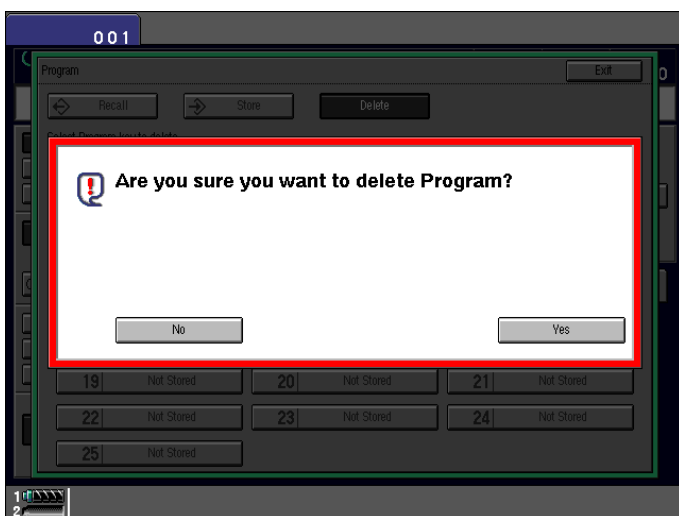

Note

To cancel the deletion, press the **[No]** key.

5 To delete another program, repeat steps **3** and **4**.

Recalling a Program

- 1 Press the **[Program]** key.

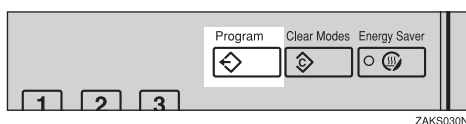

- 2 Press the program number you want to recall.
The stored settings are displayed.

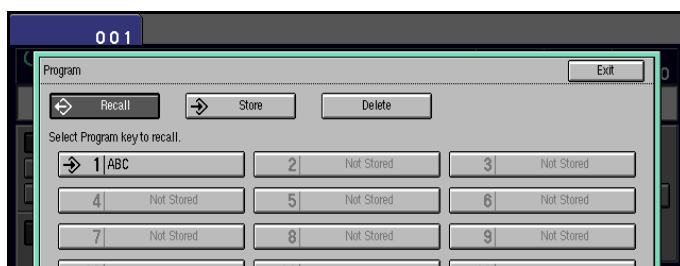

Note

- Only programs with  contain a program.

- 3 Set your originals then press the **[Start]** key.

Job Preset

If a long copy job is in progress and you do not wish to wait for it to finish, you can use this feature to set up the next copy job in advance. When the current copy job is finished, your copy job will be started automatically.

Limitation

- You can not combine Job Preset function with Connect Copy function (option).

Note

- The maximum number of jobs sets that you can set with this feature is 10.
- You can use this feature for the documents stored in Document Server.

1 Press the [New Job] key.

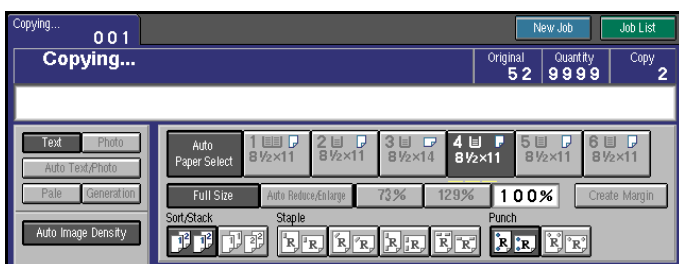

2 Set up the next copy job.

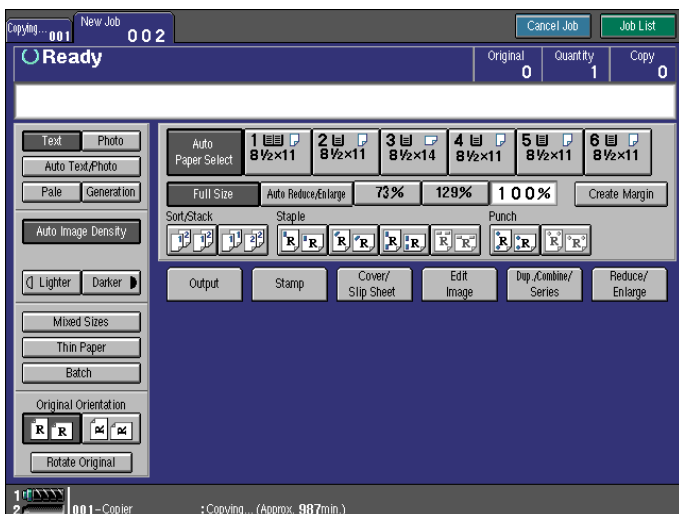

Note

- To cancel this job, press the [Cancel Job] key.

3 Set the originals.

To set the original in the document feeder

- 1 Set a stack of originals in the document feeder, then press the **[Start]** key.

 **Note**

- The last page should be on the bottom.
-

To set the original on the exposure glass or in the document feeder using Batch/SADF mode

 **Reference**

See ⇒ P.32 “Batch/SADF Mode”.

- 1 Set the original, then press the **[Start]** key.

 **Note**

- Start with the first page to be copied.

- 2 When it has been scanned in, set the next original, then press the **[Start]** key.

 **Note**

- Set the original in the same direction as the first one.

- 3 After all originals have been scanned, press the **[#]** key.

The copies are delivered to the tray.

 **Note**

- When you wish to return the copying display, press the [Stop Copying] key on the display panel.
-

Editing Job Preset

- 1 Press the **[Job List]** key.

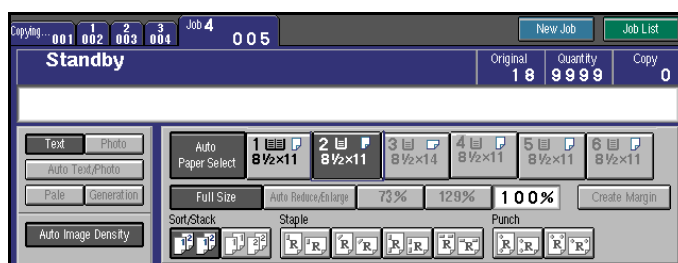

2 Press the [Change] key.

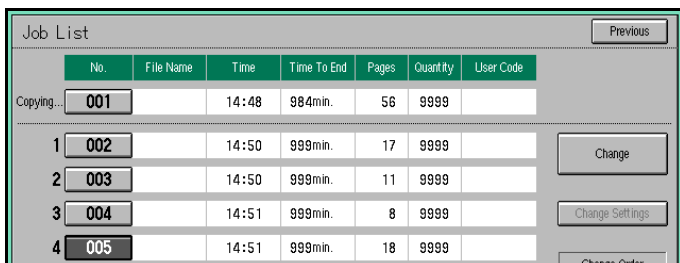

3 Press the number of the job you want to change.

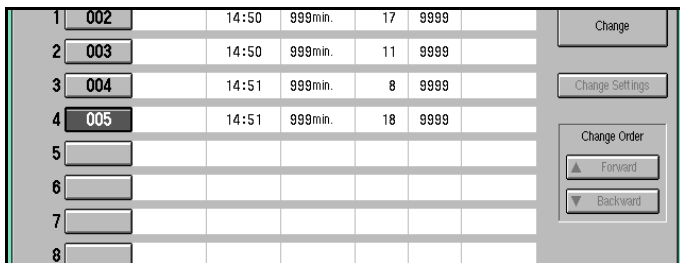

4 Press the [Change Settings] key.



5 Change the setting, then press the [Exit] key.

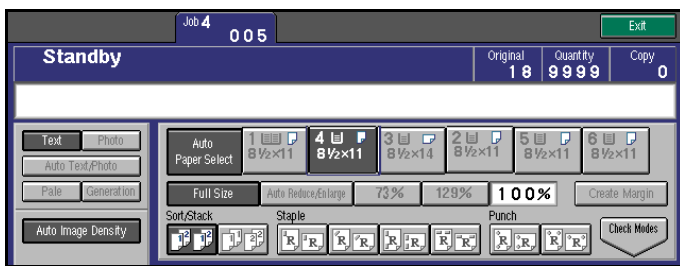

6 Press the [Yes] key.

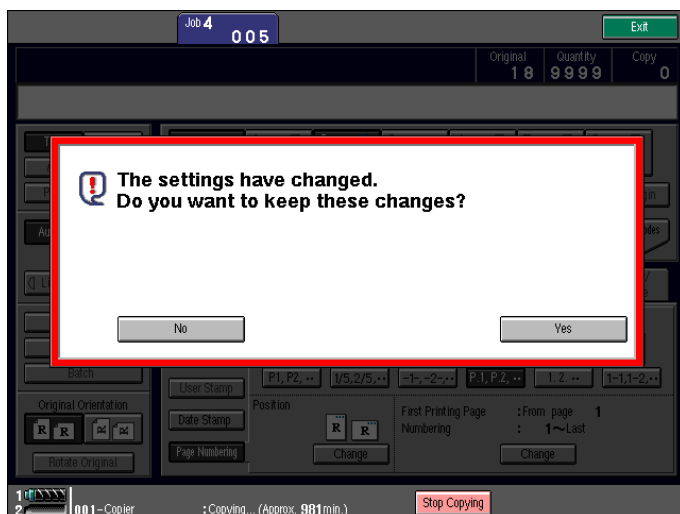

Note

- To cancel the changes, press the [No] key.

7 Press the [Exit] key.

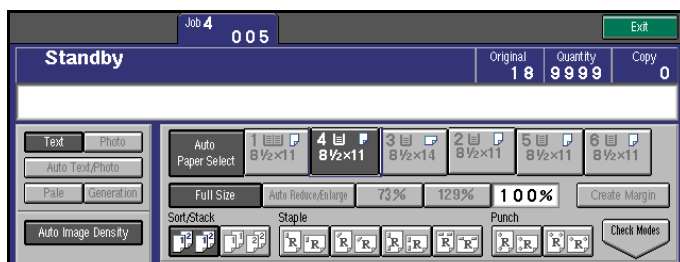

Note

- When you want to change the other New Job, repeat 3 and 6.

8 Press the [Previous] key.

The initial display reappears.

Changing the Order of the Job Preset

1 Press the [Job List] key.

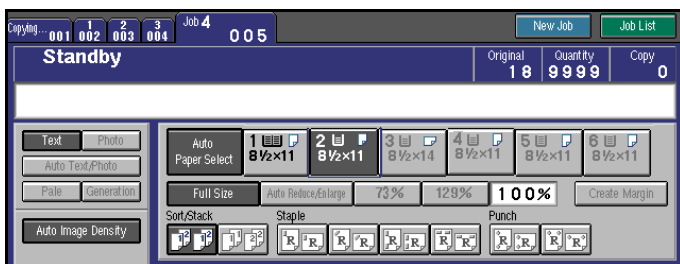

2 Press the [Change] key.

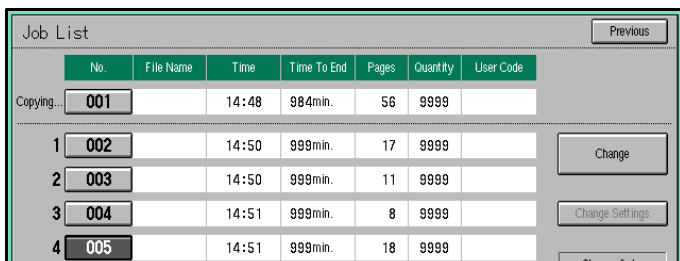

3 Press the number of the job you want to change.

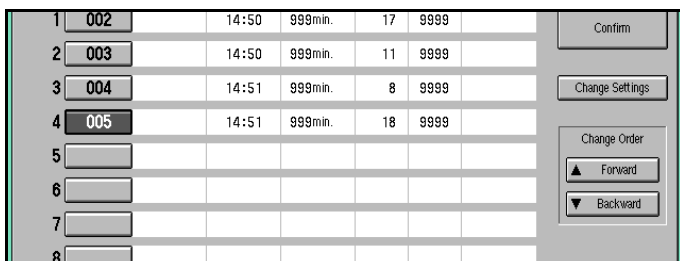

- 4** Change the order using the [▲Forward] key or [▼Backward] key.

The screenshot shows the 'Job List' screen with a table of jobs. The 'No.' column contains job numbers 001 through 10. The 'Time' column shows the current time (14:48) and the 'Time To End' column shows the estimated completion time (979min. to 999min.). The 'Pages' and 'Quantity' columns show the number of pages and the quantity of copies respectively. The 'User Code' column shows the user code (9999). The 'Copying...' status is shown as 'Copying...'. The 'Confirm' button is highlighted. The 'Change Order' section contains the 'Forward' and 'Backward' buttons. The 'Delete' button is also visible.

No.	File Name	Time	Time To End	Pages	Quantity	User Code
Copying...		14:48	979min.	56	9999	
1		14:50	999min.	17	9999	
2		14:50	999min.	11	9999	
3		14:51	999min.	18	9999	
4		14:51	999min.	8	9999	
5						
6						
7						
8						
9						
10						

1 001 - Copier : Add paper Stop Copying

- 5** Press the [Confirm] key.

The screenshot shows the 'Job List' screen with the 'Confirm' button highlighted. The table of jobs is the same as in the previous screenshot.

No.	File Name	Time	Time To End	Pages	Quantity	User Code
Copying...		14:48	979min.	56	9999	
1		14:50	999min.	17	9999	
2		14:50	999min.	11	9999	
3		14:51	999min.	18	9999	
4		14:51	999min.	8	9999	

- 6** Press the [Previous] key.

The initial display reappears.

Deleting Job Preset

1 Press the [Job List] key.

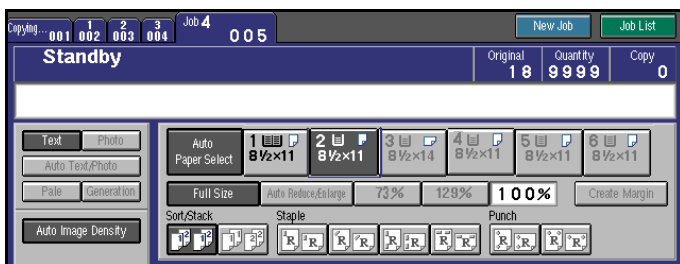

2 Press the [Change] key.

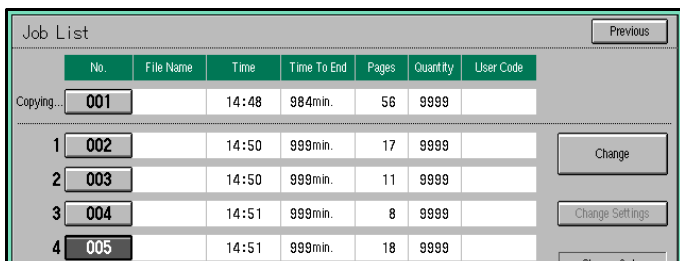

3 Press the number of the job you want to delete.

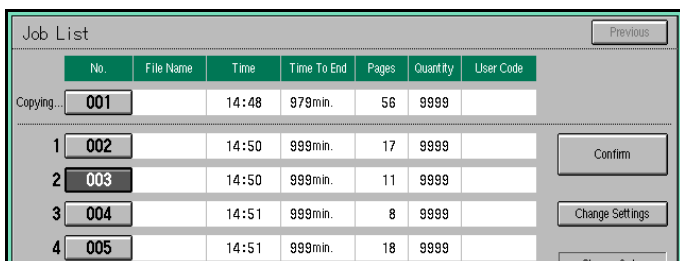

4 Press the [Delete] key.

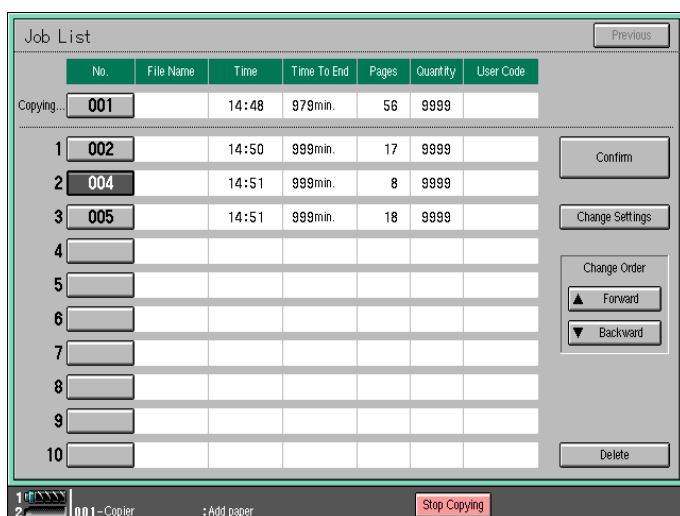

2

5 Press the [Confirm] key.

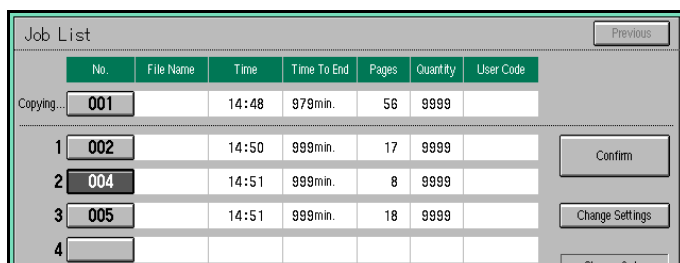

6 Press the [Previous] key.

The initial display reappears.

Other Functions

Energy Saver Mode

If you do not operate the machine for a certain period after copying, or when you press the **[Energy Saver]** key, the display goes blank and the machine enters Energy Saver mode. When you press the **[Energy Saver]** key again, when the originals are set in the document feeder, or when the document feeder is opened, the machine returns to the ready condition. In Energy Saver mode, the machine uses less electricity.

Energy Saver mode makes a two-step reduction in electricity: one for the period up to the time set for Panel Off & Energy Saver mode, the other for the period after that time.

Note

- If you press the **[Energy Saver]** key during an operation, the current settings will be cleared.
- It takes about 5 seconds to return to the ready condition from Energy Saver mode.
- It takes about 40 seconds to return to the ready condition from Panel Off & Energy Saver mode.
- If you press the **[Connect]** key on the master unit, the sub-unit exits Energy Saver mode and enters Connect Copy mode.
- In Connect Copy mode, the sub-unit will not enter Energy Saver mode.

Reference

See “Panel Off Timer” and “Energy Saver Timer” in the System Settings manual for more information.

Interrupt Copy

Use this function if you wish to interrupt a long copy job to make urgently need copies.

Note

- The procedure for making interrupt copies depends on which kind of operation the machine is currently carrying out.
- You can use Document Server mode in Interrupt Copy mode.
- In Connect Copy mode, you cannot use Interrupt Copy function on the sub-unit while the master unit is scanning an original.
- In Connect Copy mode, you cannot use Interrupt Copy function when memory on the sub-unit is full.
- Please exit the Interrupt mode after finishing the job.

To interrupt an original being fed

1 Press the Interrupt key.

The Interrupt key lights up and scanning stops.

2 Remove the originals that were being copied and set the originals you wish to copy.**3 Press the **[Start]** key.**

The machine starts making your copies.

4 When your copy job is finished, remove your originals and copies.**5 Press the Interrupt key again.**

The Interrupt key indicator goes out.

6 When the display prompts you to, replace the originals that were being copied before.**7 Press the **[Start]** key.**

The previous copy job settings will be restored and the machine will continue copying from where it left off.

To interrupt copying after all originals have been fed

1 Press the Interrupt key.

The Interrupt key lights.

 **Note**

Copying will not stop yet.

2 Set your original.**3 Press the **[Start]** key.**

The machine stops the original job and starts copying your original.

4 When copying is complete, remove your originals and copies.**5 Press the Interrupt key again.**

The Interrupt indicator goes out.

The previous copy job settings will be restored and the machine will continue copying from where it left off.

User Codes

If the User Code function is turned on, operators must input their user codes before the machine can be operated. The machine keeps count of the number of copies made under each user code.

Note

- When the machine is set for user codes, the machine will prompt you for your user codes after the operation switch is on or the Auto Reset feature comes into effect.
- You can adjust how long the machine waits before switching to the user code input display. See “Copy Reset Timer” ⇒ P.312 “General Features”.
- To prevent others from making copies using your user code, press the **[Clear Modes]** and **[Clear]** keys simultaneously after copying.
- You can turn User Codes on or off with the master unit System Settings. See “User Codes:Copier/Document Server” in the System Settings manual.
- You can monitor the total number of copies made by the master unit and sub-unit with the master unit User Codes function.
- If User Codes are set on in the sub-unit and a code has been entered before Connect Copy was selected, the master unit cannot monitor the number of copies made.
- If User Codes are set only in the sub-unit, you can enter Connect Copy mode and make copies without entering a code. In this case the number of copies made will not be monitored.

Reference

For how to set up user codes, see “Settings You Can Change With The User Tools” in the System Settings manual.

For how to register, change and delete user codes, see “Program/Change/Delete User Code” ⇒ P.331 “Key Operator Tools”.

Auto Start

If you press the **[Start]** key during the warm-up period, the **[Start]** key will blink and your copies will be made as soon as the warm-up finishes.

Note

- Copying will start if “Ready” is displayed on the master unit in Connect Copy mode.

1 Make any adjustments to copy settings during the warm-up period.

2 Set your originals.

3 Press the **[Start]** key.

Copying automatically starts when the **[Start]** key indicator flashes red and green and the machine is ready for copying.

 **Note**

- To cancel Auto Start, press the **[Stop]** key.
- In Connect Copy mode, press the **[Stop]** key on the master unit to cancel Auto Start.

Original Tone

The tone sounds and an error message is displayed when you leave your original on the exposure glass after copying, and set your originals in the document feeder after copying.

 **Note**

- To stop the Original Tone, see “Original Tone” ⇒ P.316 “Display/Panel Tone”.

Sample Copy

Use this feature to check a copy set before making a long copy run.

 **Limitation**

- This function can be used only when the Sort function has been turned on.

 **Note**

- This function is only available on the master unit in Connect Copy mode.

1 Select Sort and any other functions, then enter the number of copies to be made.

2 Set the originals.

3 Press the **[Sample Copy]** key.

One copy is delivered for proof copying.

4 After checking the finish, press the **[Print]** key if the sample is acceptable.

The number of copies mode is the number you specified minus one for the proof copy.

 **Note**

- If you press **[Stop]** after checking change, return to step **1** to adjust the copy settings as necessary. You can change some settings. e.g., staple, punch, margin adjust settings

Preset Reduce/Enlarge

Use this feature to select a preset magnification ratio for copying.

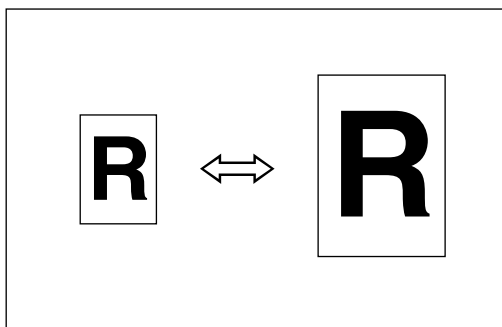

Note

- You can select one of 12 preset ratios (5 enlargement ratios, 7 reduction ratios).
- You can change the preset ratios to other ratios you frequently use. See ⇒ P.314 “Set Ratio”.
- You can set and display two shortcut R/E ratios on the initial display. See “Shortcut R/E” ⇒ P.314 “Set Ratio”.
- You can select a ratio regardless of the size of an original or copy paper. With some ratios, parts of the image might not be copied or margins will appear on copies.
- You can change the ratio on the key 71% displayed.
- If you press “Create Margin” key, the image is reduce 93% and moved center of copy paper. You can change the ratio of this function. See ⇒ P.314 “Set Ratio”
- Copies can be reduced or enlarged as follows:

◆ Metric version

Ratio (%)	Original → Copy Paper Size
400 (enlarge area by 16)	--
200 (enlarge area by 4)	A5→A3
141 (enlarge area by 2)	A4→A3, A5→A4
122	F→A3, A4→B4
115	B4→A3
93	--
82	F→A4, B4→A4
75	B4→F4, B4→F

Ratio (%)	Original → Copy Paper Size
71 (reduce area by $\frac{1}{2}$)	A3→A4, A4→A5
65	A3→F
50 (reduce area by $\frac{1}{4}$)	A3→A5, F→A5
25 (reduce area by $\frac{1}{16}$)	

❖ Inch version

Ratio (%)	Original → Copy Paper Size
400 (enlarge area by 16)	--
200 (enlarge area by 4)	$5\frac{1}{2}'' \times 8\frac{1}{2}'' \rightarrow 11'' \times 17''$
155 (enlarge area by 2)	$5\frac{1}{2}'' \times 8\frac{1}{2}'' \rightarrow 8\frac{1}{2}'' \times 14''$
129	$8\frac{1}{2}'' \times 11'' \rightarrow 11'' \times 17''$
121	$8\frac{1}{2}'' \times 14'' \rightarrow 11'' \times 17''$
93	--
85	F→ $8\frac{1}{2}'' \times 11''$
78	$8\frac{1}{2}'' \times 14'' \rightarrow 8\frac{1}{2}'' \times 11''$
73	$11'' \times 15'' \rightarrow 8\frac{1}{2}'' \times 11''$
65	$11'' \times 17'' \rightarrow 8\frac{1}{2}'' \times 11''$
50 (reduce area by $\frac{1}{4}$)	$11'' \times 17'' \rightarrow 5\frac{1}{2}'' \times 8\frac{1}{2}''$
25 (reduce area by $\frac{1}{16}$)	

1 Press the [Reduce/Enlarge] key.

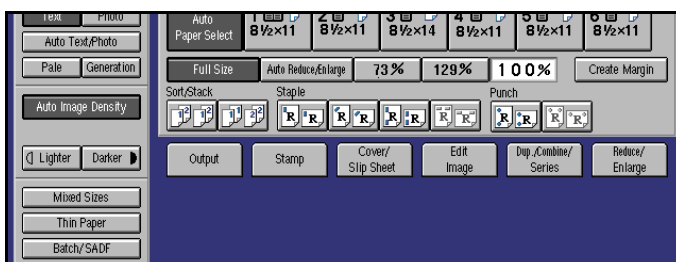

Note

- To select a preset ratio in the initial display, directly press the shortcut reduce/enlarge key and proceed to step **2**.

2 Select a ratio.

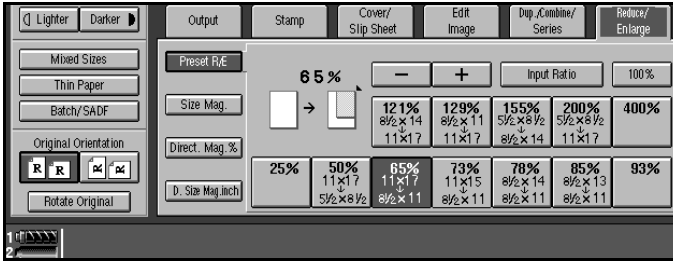

Note

- You can specify the reduce/enlarge ratios of the keys displayed when the [Reduce/Enlarge] key is touched. See ⇒ P.314 "Set Ratio"

3 Set your originals then press the [Start] key.

To create a margin

Use "Create Margin" mode to reduce the image by 93 % of its original size with the center position as reference. You can register this function in a shortcut key in the initial display. By combining it with the Reduce/Enlarge function, you can also provide the Reduce/Enlarge copy with a margin.

Note

- You can change the Reduce/Enlarge ratio for "Create Margin". See "Create Margin" ⇒ P.314 "Set Ratio".

1 Press the [Create Margin] key displayed in the initial display.

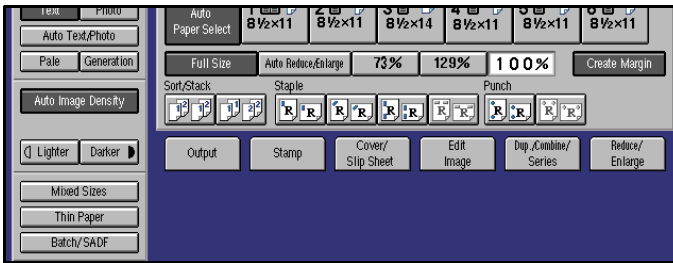

2 If you do not wish to use the Reduce/Enlarge function as well, set your originals then press the [Start] key.

Zoom

Zoom lets you change the reproduction ratio in 1 % steps.

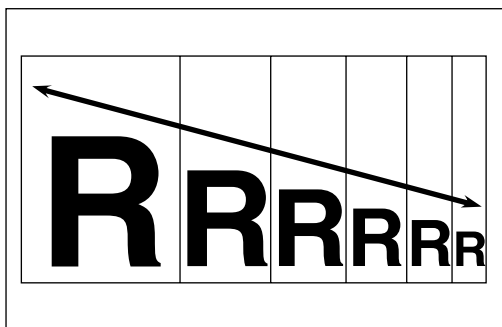

Note

- You can select a ratio within the following range:
 - Metric version: 25 – 400 %
 - Inch version: 25 – 400 %
- You can select a ratio regardless of the size of an original or copy paper. With some ratios, parts of the image might not be copied or margins will appear on copies.
- You can select a preset ratio which is near the desired ratio, then adjust the ratio with the **[+]** or **[-]** key.

1 Press the **[Reduce/Enlarge]** key.

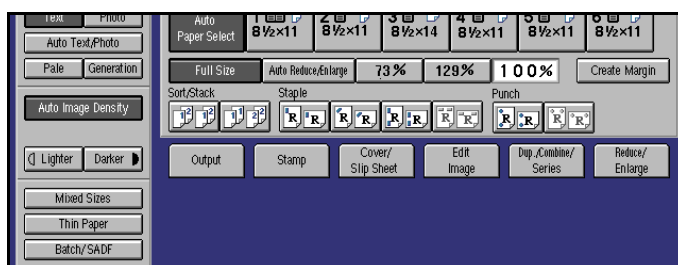

2 Enter the ratio.

To select the ratio with the **[+]** and **[-]** keys

- 1** Select a preset ratio which is close to the desired ratio by using Preset Reduce/Enlarge.

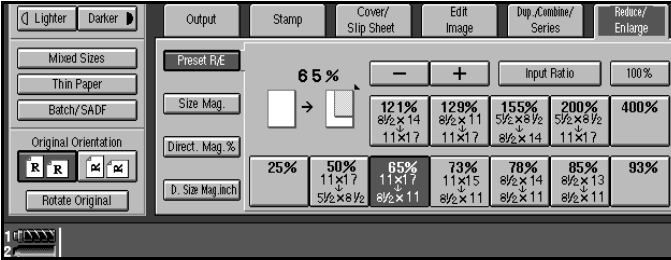

- 2** Adjust the ratio with the **[+]** or **[-]** key.

Note

- To change the ratio in 1 % steps, just press the **[+]** or **[-]** key. To change the ratio in 10 % steps, press and hold down the **[+]** or **[-]** key.

To enter the ratio with the number keys

- 1** Press the **[Input Ratio]** key.

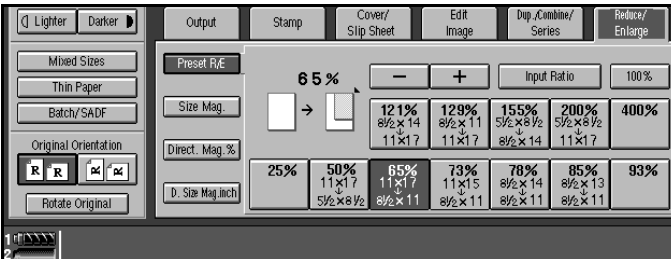

- 2** Enter the desired ratio with the number keys.

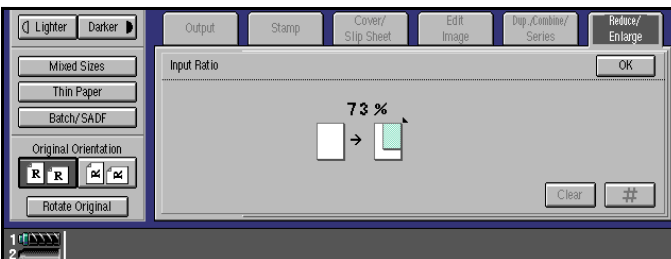

Note

- To change the ratio entered, press the **[Clear]** key and enter the new ratio.

- 3** Press the **[#]** key.

- 4** Press the **[OK]** key.

- 3** Set your originals then press the **[Start]** key.

Size Magnification

This function calculates an enlargement or reduction ratio based upon the lengths of the original and copy.

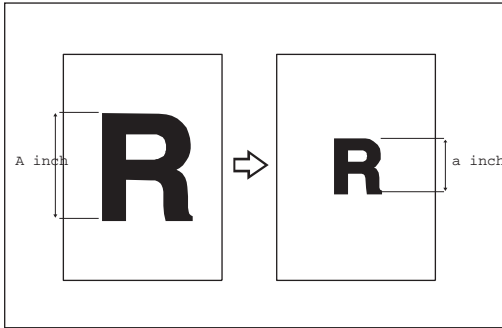

2

Preparation

Measure the length of the image you wish to modify.

Note

- A ratio is selected in the range of 25 to 400 %.
- If the calculated ratio is over the maximum or under the minimum ratio, it is corrected within the range of the ratio automatically. However, with some ratios, parts of the image might not be copied or blank margins will appear on copies.

1 Press the [Reduce/Enlarge] key.

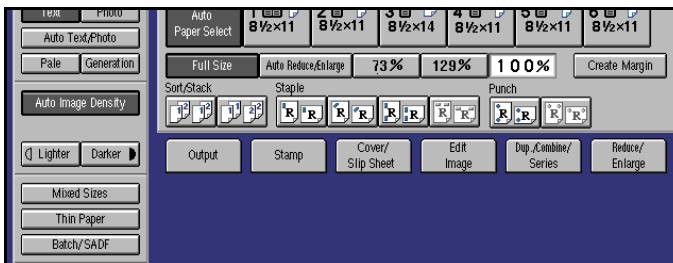

2 Press the [Size Mag.] key.

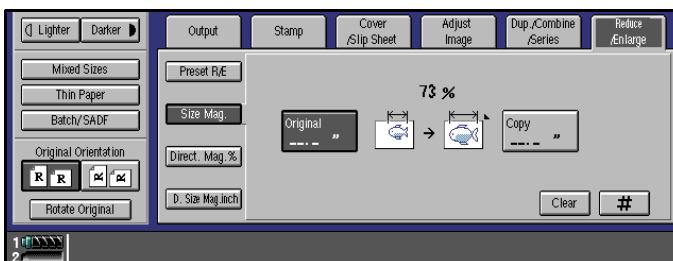

3 Enter the length of the original with the number keys and press the [#] key.

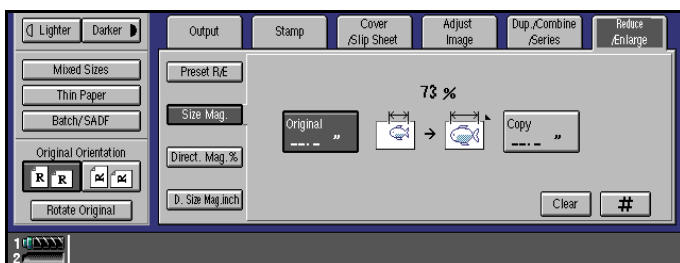

Note

You can enter sizes within the following ranges:

Metric version	1 - 999 mm (in 1 mm steps)
Inch version	0.1" - 99.9" (in 0.1" steps)

To change the length entered, press the **[Clear]** key on the control panel or **[Clear]** key on the display and enter the new length.

4 Enter the length of the copy with the number keys and press the [#] key.

Note

To change the length entered, press the **[Clear]** key on the control panel or **[Clear]** key on the display and enter the new length.

To change the length after pressing the [#] key, select **[Original]** or **[Copy]** key and enter the desired length.

5 Set your original, then press the **[Start]** key.

Directional Magnification (%)

With Directional Magnification, copies can be reduced or enlarged at different reproduction ratios horizontally and vertically.

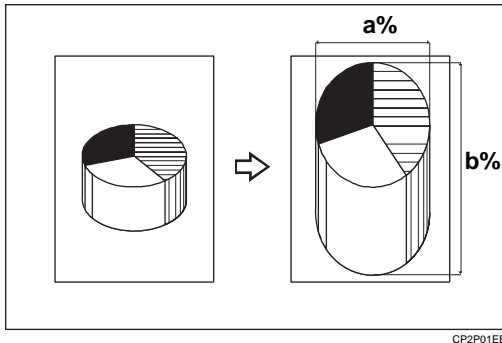

a: Horizontal

b: Vertical

Note

- You can select ratios within the following range:
 - Metric version: 25 – 400 %
 - Inch version: 25 – 400 %
- You can select a ratio regardless of the size of an original or copy paper. With some ratios, parts of the image might not be copied or blank margins will appear on copies.
- You can also select a preset ratio which is close to the desired ratio by using Reduce or Enlarge, then adjust the ratio with the **[+]** or **[-]** key.

1 Press the [Reduce/Enlarge] key.

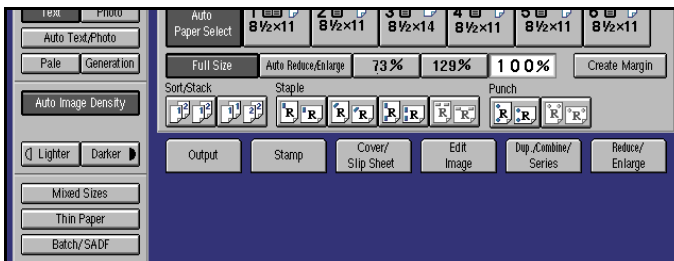

Note

- When specifying a ratio with the **[+]** or **[-]** key, select a preset ratio which is close to the desired ratio by using **[Reduce]** or **[Enlarge]**.

2 Press the [Direct. Mag. %] key.

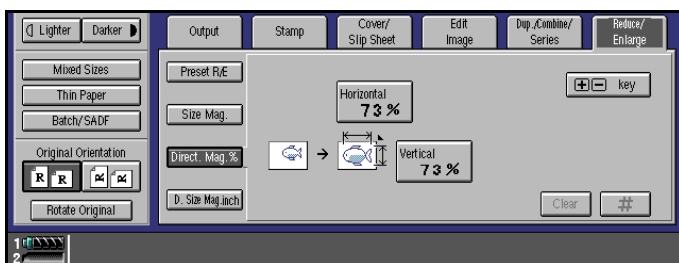

To specify the ratio with the [+] and [-] keys

1 Press the [+ - keys] key.

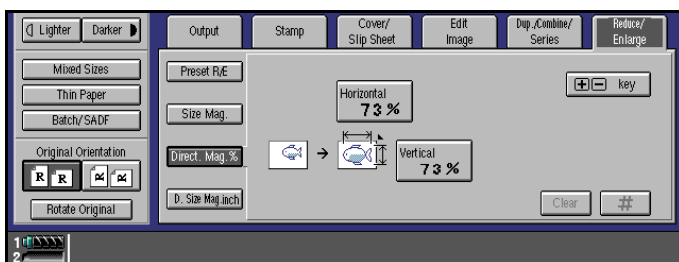

2 Press the [Horizontal] key.

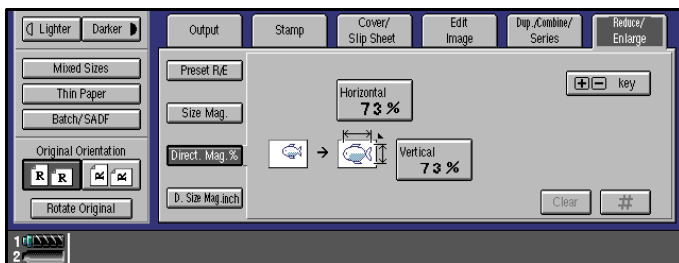

3 Adjust the ratio using the [+] or [-] key.

Note

- Touching the [+] or [-] key changes the ratio in 1 % steps. Touching and holding down the [+] or [-] key changes it in 10 % steps.

4 Press the [Vertical] key.

5 Adjust the ratio with the [+] or [-] key.

To enter the ratio with the number keys

- 1 Press the **[Horizontal]** key.

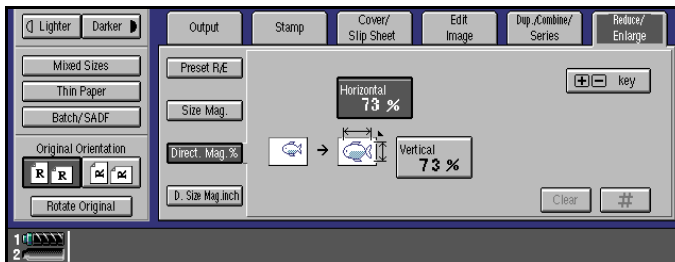

- 2 Enter the desired ratio with the number keys, followed by the **[#]** key.

Note

- To change the ratio entered, press the **[Clear]** key on the control panel or **[Clear]** key on the display and enter the new ratio.

- 3 Press the **[Vertical]** key.
 - 4 Enter the desired ratio with the number keys, followed by the **[#]** key.
- 3 Set your originals then press the **[Start]** key.

Directional Size Magnification (inch)

The suitable reproduction ratios will be automatically selected when you enter the horizontal and vertical lengths of the original and copy image you require.

2

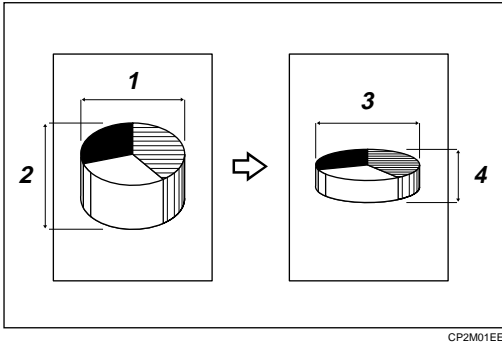

- 1: Horizontal original size
- 2: Vertical original size
- 3: Horizontal copy size
- 4: Vertical copy size

 **Preparation**

Specify the vertical and horizontal sizes of the original and those of the copy, as shown in the illustration.

 **Note**

You can enter sizes within the following ranges:

Metric version	1 – 999 mm (in 1 mm steps)
Inch version	0.1" – 99.9" (in 0.1" steps)

You can select ratios within the following range:

- Metric version: 25 - 400%
- Inch version: 25 - 400%

If the calculated ratio is over the maximum or under the minimum ratio, it is corrected within the range of the ratio automatically. However, with some ratios, parts of the image might not be copied or blank margins will appear on copies.

1 Press the [Reduce/Enlarge] key.

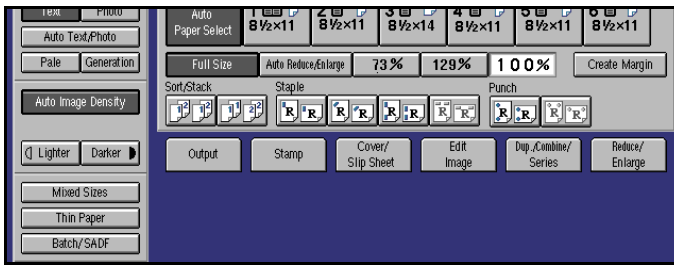

2 Press the [D. Size Mag. inch] key.

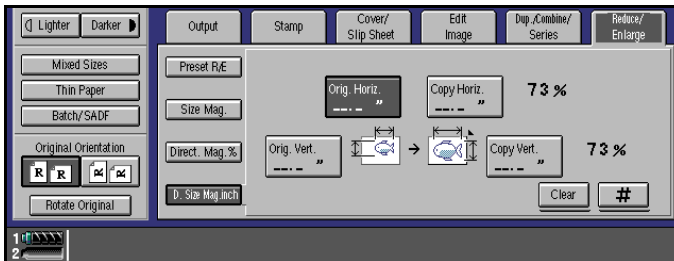

3 Enter the horizontal size of the original with the number keys then press the [#] key.

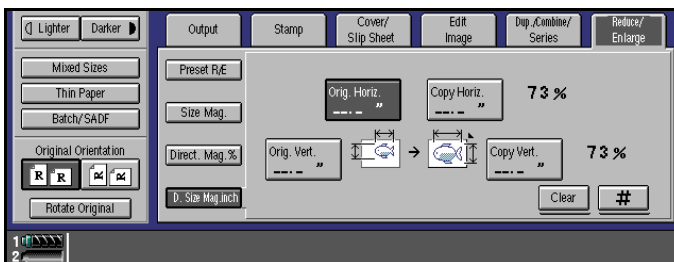

Note

- To change the value entered, press the [Clear] key on the control panel or the [Clear] key on the display and enter the new value.

4 Enter the horizontal size of the copy with the number keys then press the [#] key.

5 Enter the vertical size of the original with the number keys then press the [#] key.

6 Enter the vertical size of the copy with the number keys then press the [OK] key.

Note

- To edit a size, press the item you wish to change and enter the new value.

7 Set your originals then press the [Start] key.

Duplex

You can make two-sided copies in two ways:

❖ 1 Sided → 2 Sided

This mode makes two-sided copies from one-sided originals.

❖ 2 Sided → 2 Sided

This mode makes two-sided copies from two-sided originals.

🚫 Limitation

❑ You cannot use the following types of copy paper with this function:

- Paper thicker than 163 g/m², 90 lb. Index
- Paper thinner than 64 g/m², 16 lb. Bond
- Tracing paper
- Adhesive labels
- OHP transparencies

1 Sided → 2 Sided

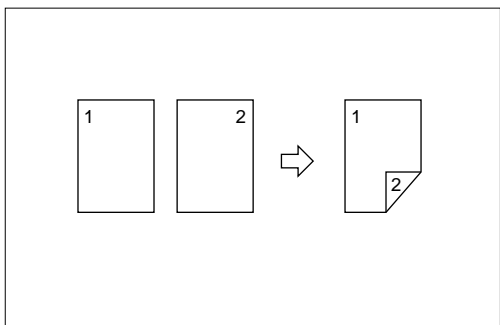

📌 Note

- ❑ When original images are copied, the images can be shifted to create a binding margin. See “Front Margin: Left/Right” “Back Margin: Left/Right” “Front Margin: Top/Bottom” “Back Margin: Top/Bottom” ⇒ P.318 “Adjust Image”.
- ❑ A binding margin is automatically made on the back side. See “1 → 2 Duplex Auto Margin Adjust” ⇒ P.318 “Adjust Image”.

Originals And Copy Direction

- Top to Top

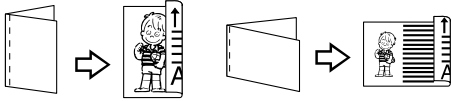

Duplex1

- Top to Bottom

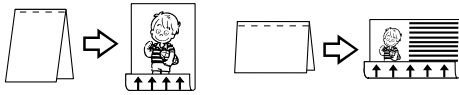

Duplex2

Original Direction And Completed Copies

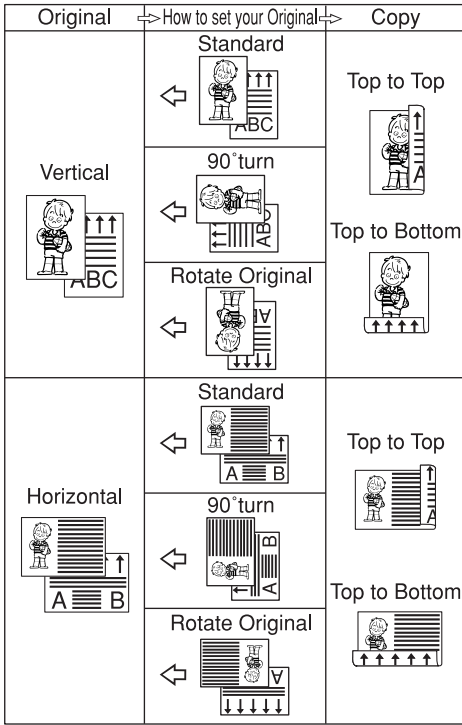

GCRYOU1E

1 Press the [Dup./Combine/Series] key.

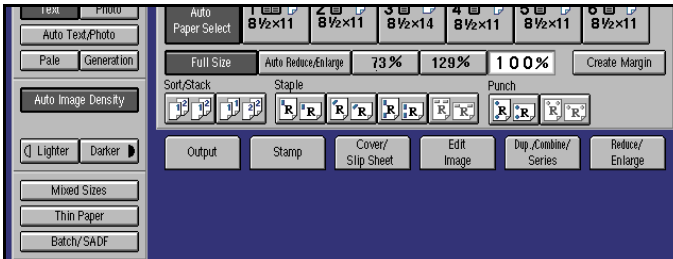

2 Press the [1 Sided → 2 Sided] key.

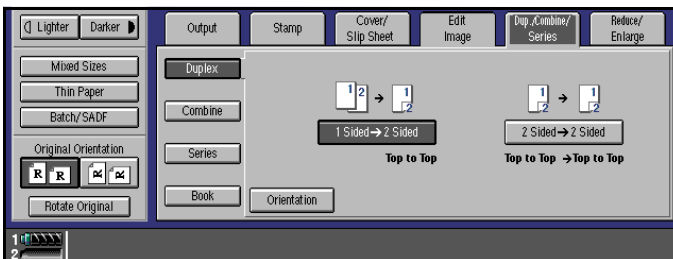

3 Check the orientation.

Note

- If you want to change the copy direction to “Top to Bottom” press the **[Orientation]** key, then press the **[Top to Bottom]** key. If you do not, go to step 5.
- The default setting is “Top to Top”. You can change this setting with the copy User Tools.⇒ P.312 “General Features”

To select “Top to Bottom”

2

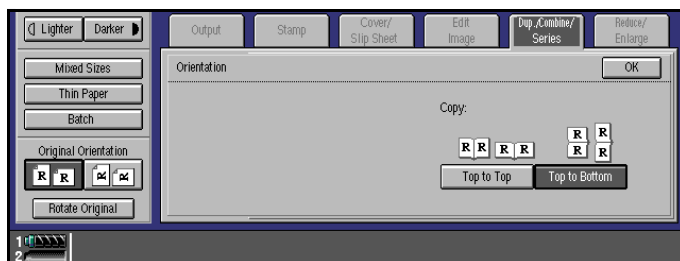
1 Press the **[Orientation]** key.**2** Press the **[Top to Bottom]** key.**3** Press the **[OK]** key.**4** Set your originals in the following way.

When setting an original on the exposure glass or in the document feeder using Batch/SADF mode

Reference

See ⇒ P.32 “Batch/SADF Mode”.

1 Set the original, then press the **[Start]** key.**Note**

- Start with the first page to be copied.
- 2** Set the next original. When it is placed on the exposure glass, press the **[Start]** key.
- 3** When the number of originals is odd, press the **[#]** key after the last original has been scanned.

2 Sided → 2 Sided

2

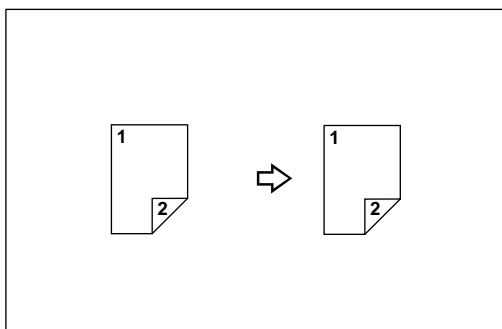

1 Press the [Dup./Combine/Series] key.

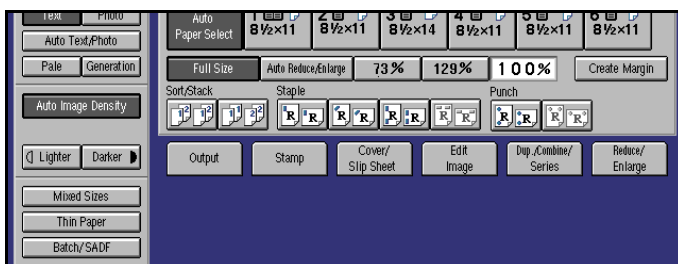

2 Press the [2 Sided → 2 Sided] key.

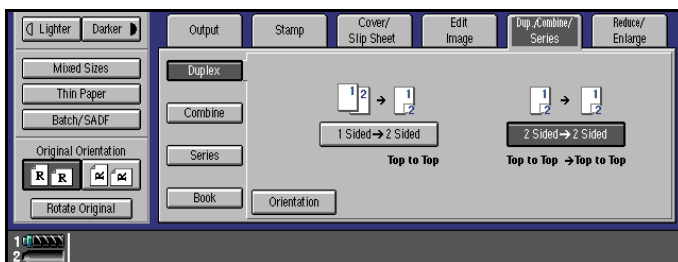

3 Check the orientation.

Note

- To change the orientation to “Top to Bottom”, press the [Orientation] key, then press the [Top to Bottom] key. If you do not, go to step 3.
- The default setting is “Top to Top”. You can change this setting with the copy User Tools. ⇒ P.312 “General Features”.

To select “Top to Bottom”

1 Press the [Orientation] key.

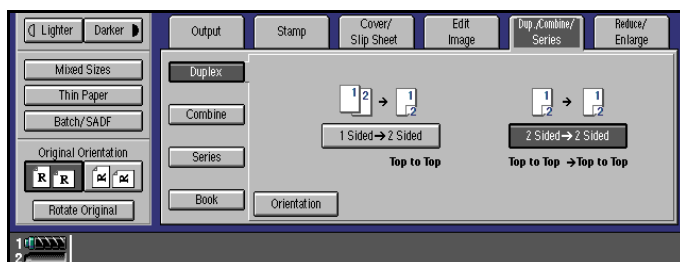

2 Select the original orientation, then the copy orientation.

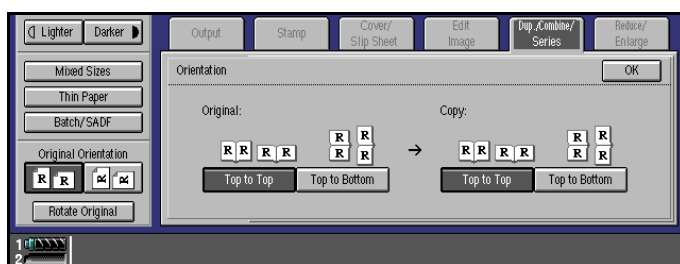

3 Press the [OK] key.

4 Set your originals in the following way.

When setting an original on the exposure glass or in the document feeder using Batch/SADF mode

Reference

See ⇒ P.32 “Batch/SADF Mode”.

1 Set the original, then press the [Start] key.

Note

Start with the first page to be copied.

2 Set the next original. When it is placed on the exposure glass, press the [Start] key.

3 Press the [#] key after the last original has been scanned.

Combine

Use this to combine two or more originals into one copy. 1 Sided Combine mode is for one-sided copies, and 2 Sided Combine mode is for two-sided copies.

You can combine images in twelve ways:

- ❖ **1 Sided 2 Pages → Combine 1 Side**
Copies two 1-sided originals on one side of a sheet
- ❖ **1 Sided 4 Pages → Combine 1 Side**
Copies four 1-sided originals together on one side of a sheet.
- ❖ **1 Sided 8 Pages → Combine 1 Side**
Copies eight 1-sided originals together on one side of a sheet.
- ❖ **1 Sided 4 Pages → Combine 2 Side**
Copies four 1-sided originals on two sides of a sheet.
- ❖ **1 Sided 8 Pages → Combine 2 Side**
Copies eight 1-sided originals on two sides of a sheet.
- ❖ **1 Sided 16 Pages → Combine 2 Side**
Copies 16 1-sided originals together on both sides of a sheet.
- ❖ **2 Sided 1 Page → Combine 1 Side**
Copies one 2-sided original on one side of a sheet.
- ❖ **2 Sided 2 Pages → Combine 1 Side**
Copies two 2-sided originals on one side of a sheet.
- ❖ **2 Sided 4 Pages → Combine 1 Side**
Copies four 2-sided originals on one side of a sheet.
- ❖ **2 Sided 2 Pages → Combine 2 Side**
Copies two 2-sided originals together on both sides of a sheet.
- ❖ **2 Sided 4 Pages → Combine 2 Side**
Copies four 2-sided originals together on two sides of a sheet.
- ❖ **2 Sided 8 Pages → Combine 2 Side**
Copies eight 2-sided originals together on two sides of a sheet.

Note

- In this mode, the machine selects the reproduction ratio automatically. This reproduction ratio depends on the copy paper sizes and the number of originals.
- The machine uses ratios in the following range:
 - Metric version: 25 – 400 %
 - Inch version: 25 – 400 %

- ❑ If the calculated ratio is under the minimum ratio, it is corrected within the range of the ratio automatically. However, with some ratios, parts of the image might not be copied or blank margins appear on copies.
- ❑ You can have separation lines printed around the copy images. See “Combine Separation Line” ⇒ P.318 “Adjust Image”.
- ❑ Even if the direction of originals is different from that of the copy paper, the machine will automatically rotate the image by 90° to make copies properly.
- ❑ When making copies in Combine mode, the border of each original can be automatically erased by 3 mm, 0.1". See “Combine Orig. Shadow Erase” ⇒ P.318 “Adjust Image”.
- ❑ If the number of originals placed is less than the number specified for Combine, pressing the [#] key allows the last page(s) to be copied blank as shown in the illustration.

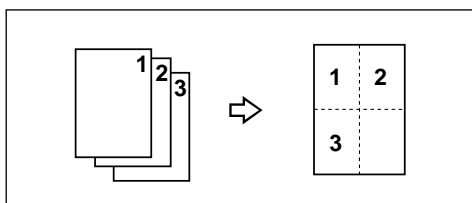

- ❑ Direction of the originals and arrangement of combined images:

❖ Portrait (📄) originals

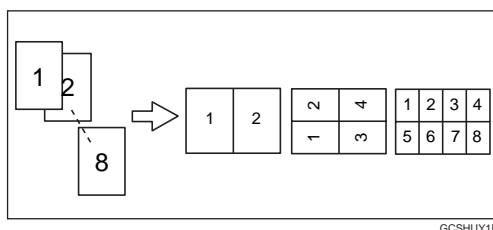

GCSHUY1E

❖ Landscape (📄) originals

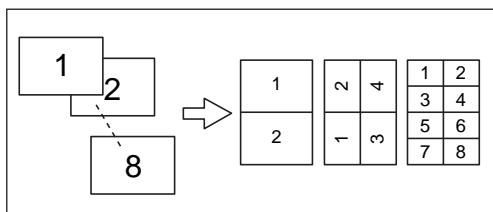

GCSHUY2E

When you use portrait originals, you can change the order of the images with the User Tools ⇒ P.312 “General Features”.

1 Sided 2 Pages → Combine 1 Side

Copies two 1-sided originals to a two-page spread.

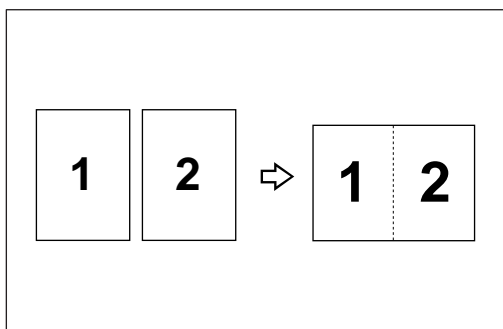

GCSHVY7J

❖ Direction in which to set originals in the document feeder

- Originals reading from left to right

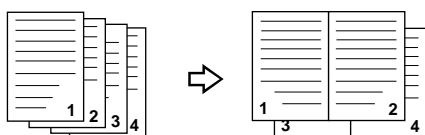

Combine5

- Originals reading from top to bottom

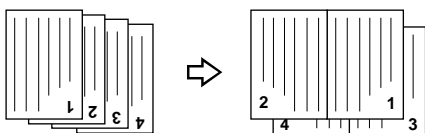

Combine6

1 Press the [Dup./Combine/Series] key.

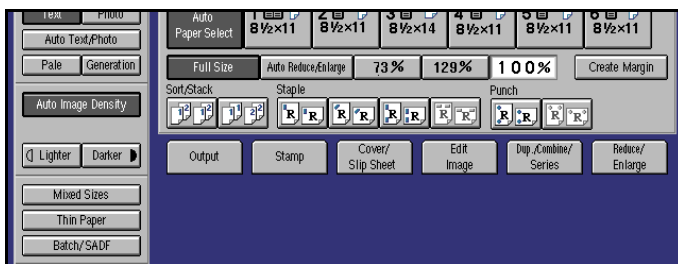

2 Press the [Combine] key.

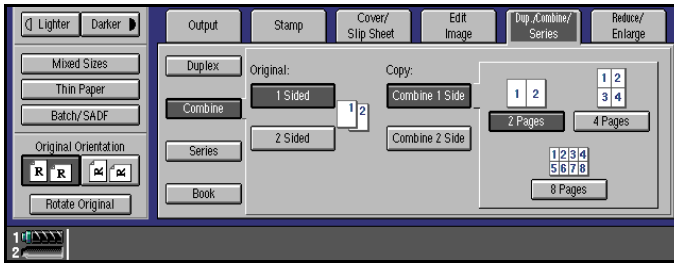

2

3 Press the [1 Sided] key for the original, then press the [Combine 1 Side] key for the copy.

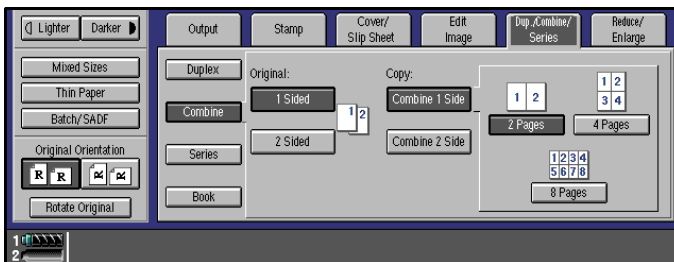

4 Press the [2 Pages] key.

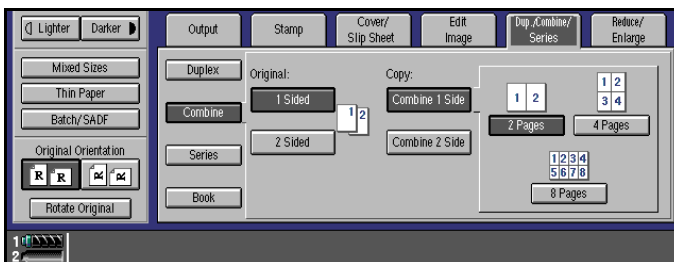

5 Select the paper.

6 Set your originals then press the [Start] key.

1 Sided 4 Pages → Combine 1 Side

Copies four 1-sided originals together to one side of a sheet.

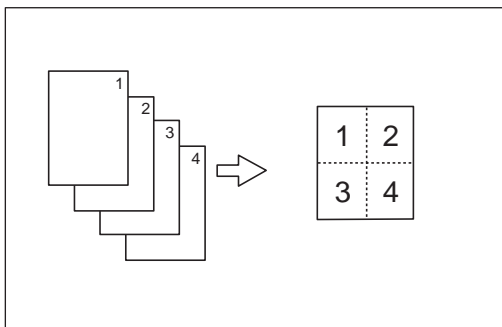

CC-BY/BJ

Note

- You can change the order that the copy is printed in Combine mode. See ⇒ P.318 “Adjust Image”.

1 Press the [Dup./Combine/Series] key.

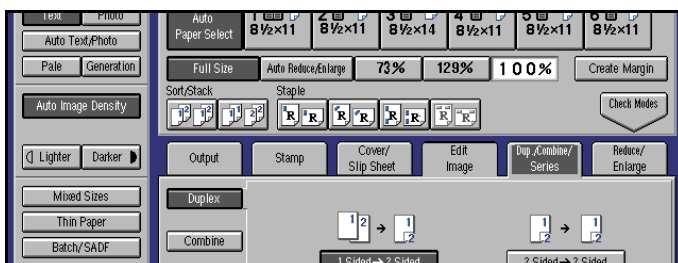

2 Press the [Combine] key.

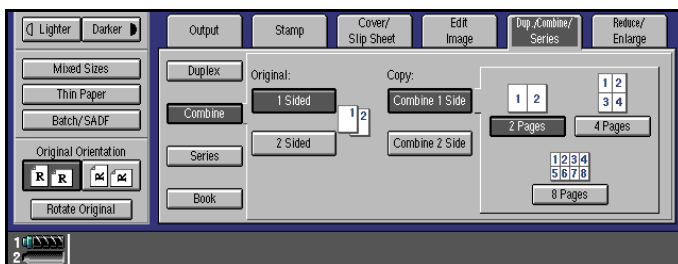

- 3** Press the [1 Sided] key for the original, then press the [Combine 1 Side] key for the copy.

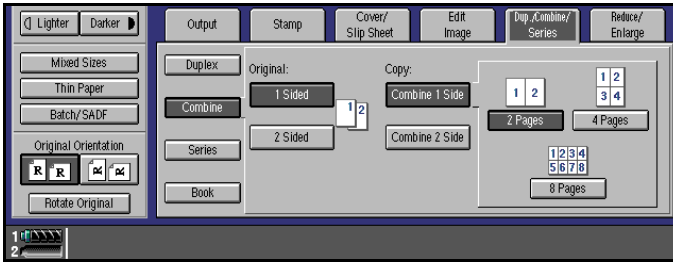

- 4** Press the [4 Pages] key.

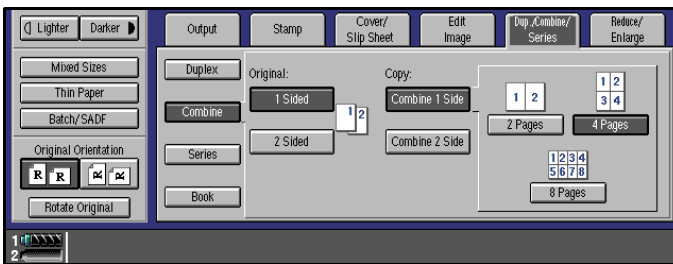

- 5** Select the paper.

- 6** Set your originals then press the [Start] key.

1 Sided 8 Pages → Combine 1 Side

Copies eight 1-sided originals together to one side of a sheet.

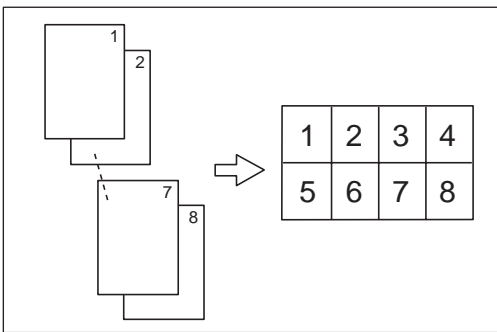

Note

- You can change the order that the copy is printed in Combine mode. See ⇒ P.318 “Adjust Image”.

1 Press the [Dup./Combine/Series] key.

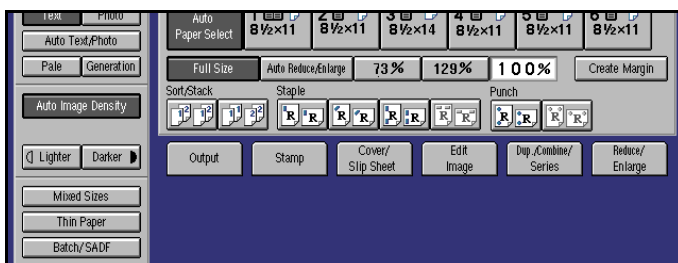

2

2 Press the [Combine] key.

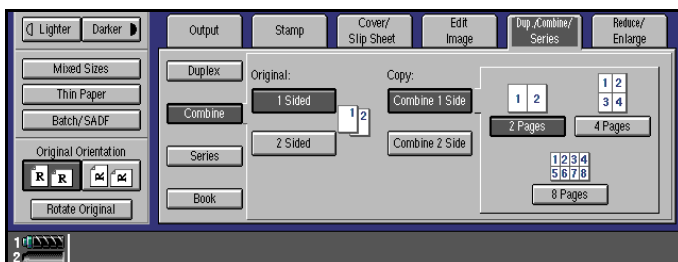

3 Press the [1 Sided] key for the original, then press the [Combine 1 Side] key for the copy.

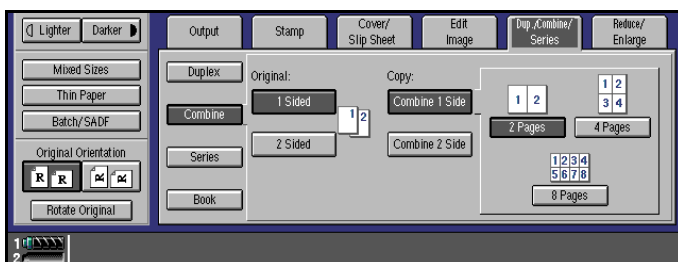

4 Press the [8 Pages] key.

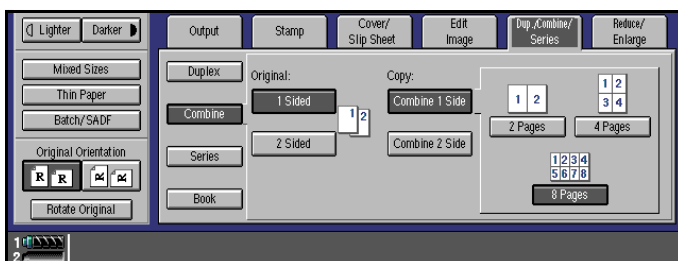

5 Select the paper.

6 Set your originals then press the [Start] key.

1 Sided 4 Pages → Combine 2 Side

Copies four 1-sided originals to the two-page spread on both sides of a sheet.

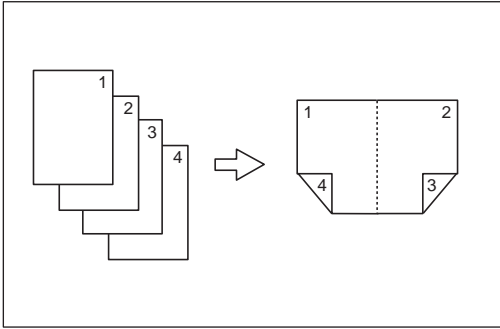

CC-BY-NC

2

1 Press the [Dup./Combine/Series] key.

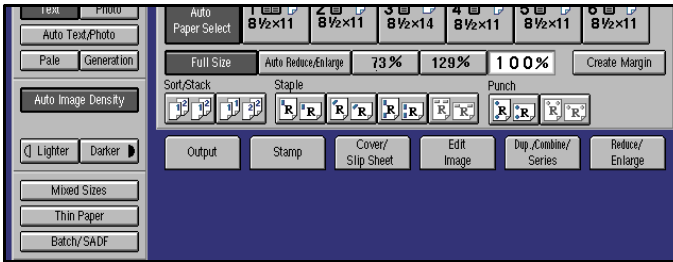

2 Press the [Combine] key.

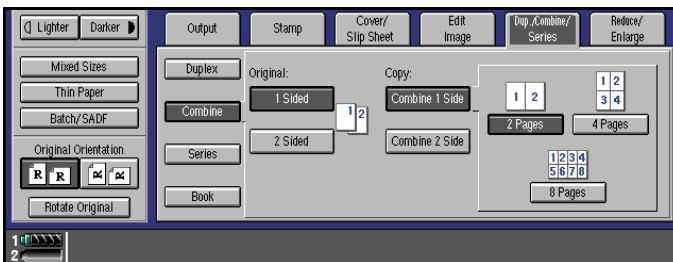

3 Press the [1 Sided] key for the original, then press the [Combine 2 Side] key for the copy.

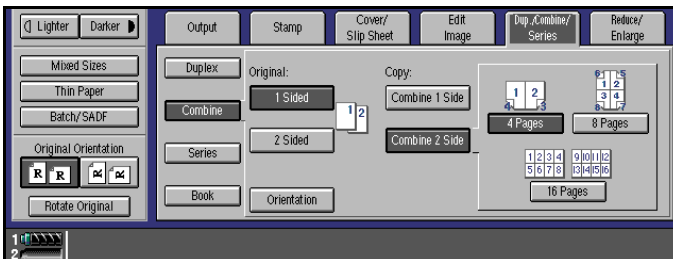

4 Press the [4 Pages] key.

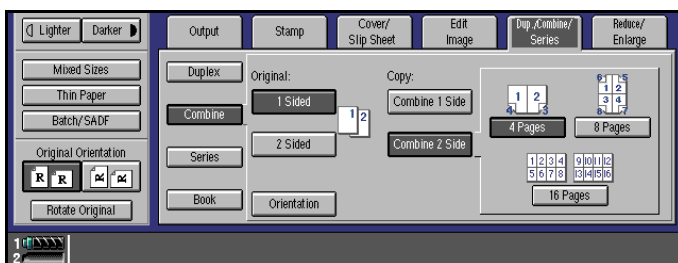

5 Check the orientation.

Note

- To change the orientation to “Top to Bottom”, press the [Orientation] key, then press the [Top to Bottom] key. If you do not, go to step **6**.
- The default setting is “Top to Top”. You can change this setting with the copy User Tools. ⇒ P.312 “General Features”.

To select “Top to Bottom”

1 Press the [Orientation] key.

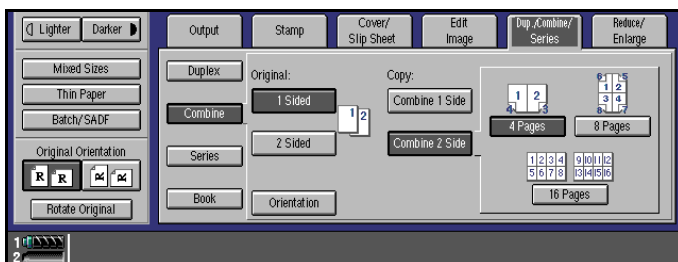

2 Press the [Top to Bottom] key, then press the [OK] key.

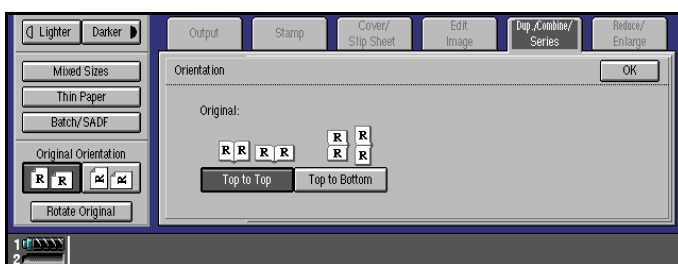

6 Select the paper.

7 Set your originals then press the [Start] key.

1 Sided 8 Pages → Combine 2 Side

Copies eight 1-sided originals together to both sides of a sheet.

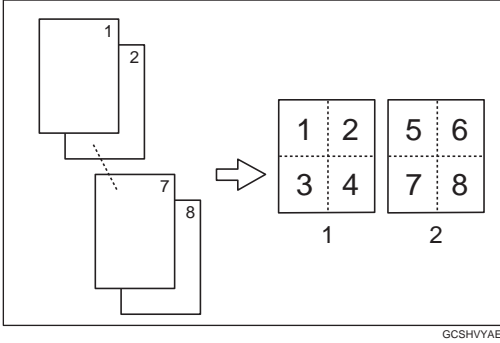

1. Front

2. Back

Note

- ❑ You can change the order that the copy is printed in Combine mode. See ⇒ P.318 “Adjust Image”.

1 Press the [Dup./Combine/Series] key.

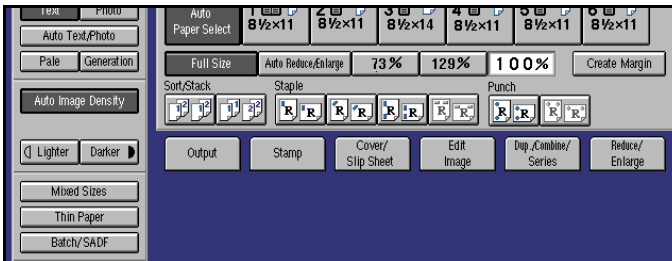

2 Press the [Combine] key.

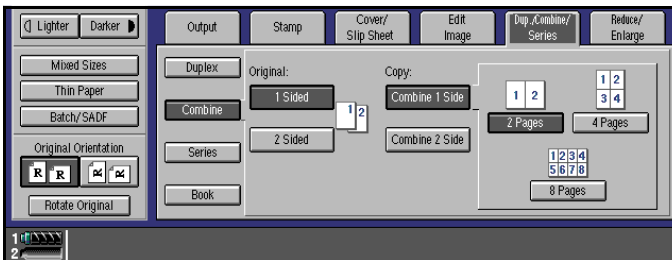

3 Press the [1 Sided] key for the original, then press the [Combine 2 Side] key for the copy.

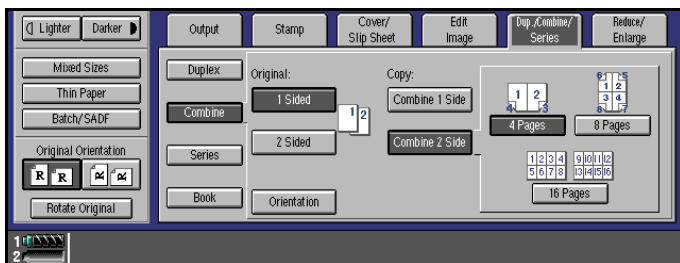

2

4 Press the [8 Pages] key.

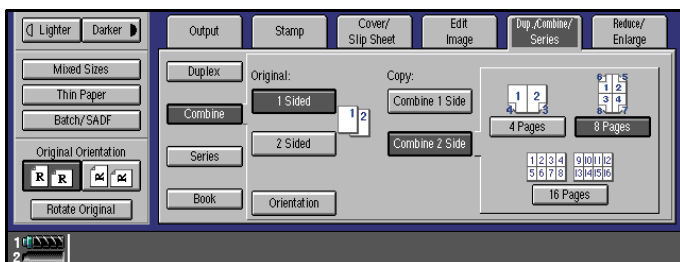

5 Check the orientation.

Note

- To change the orientation to “Top to Bottom”, press the [Orientation] key, then press the [Top to Bottom] key. If you not, go to step 6.
- The default setting is “Top to Top”. You can change this setting with the copy User Tools. See ⇒ P.312 “General Features”.

To select “Top to Bottom”

1 Press the [Orientation] key.

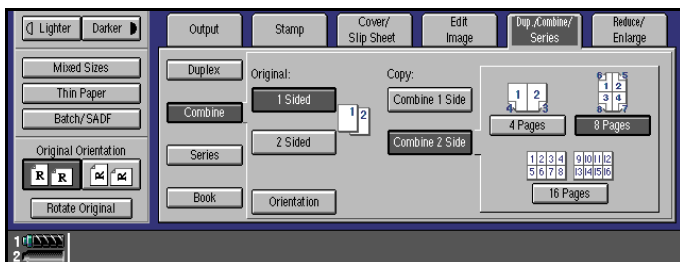

2 Press the [Top to Bottom] key then press the [OK] key.



6 Select the paper.

7 Set your originals then press the [Start] key.

1 Sided 16 Pages → Combine 2 Side

Copies sixteen 1-sided originals together to both sides of a sheet.

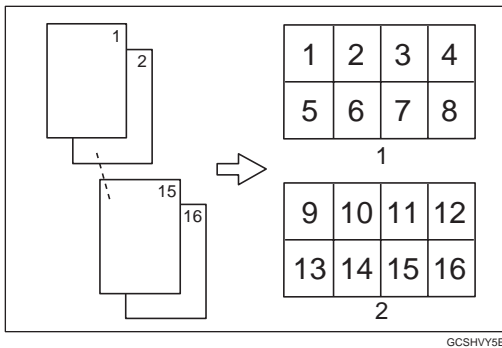

GCSHVY5E

1. Front

2. Back

Note

You can change the order that the copy is printed in Combine mode. See ⇒ P.318 "Adjust Image".

1 Press the [Dup./Combine/Series] key.

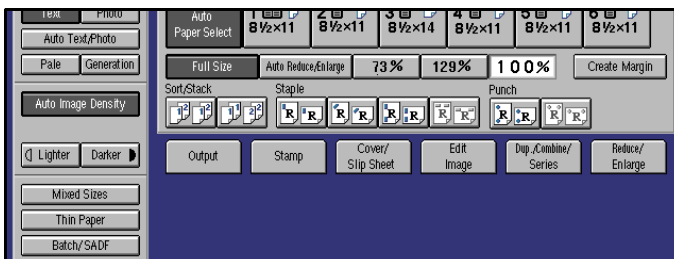

2 Press the [Combine] key.

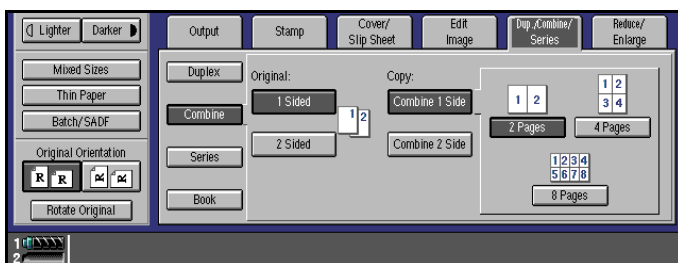

3 Press the [1 Sided] key for the original, then press the [Combine 2 Side] key for the copy.

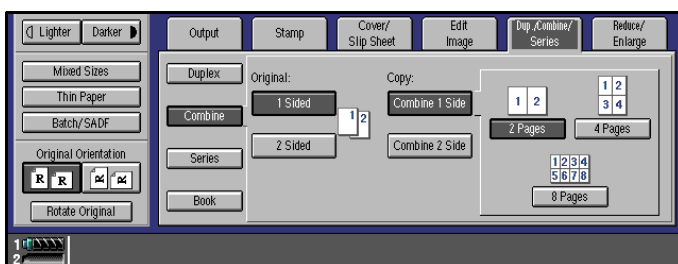

4 Press the [16 Pages] key.

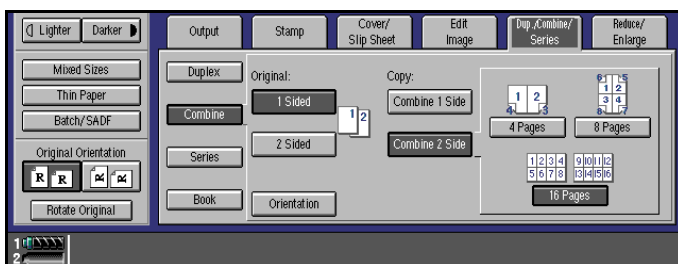

5 Check the orientation.

Note

- To change the copy orientation to “Top to Bottom”, press the [Orientation] key, then press the [Top to Bottom] key. If you do not, go to step 6.
- The default setting is “Top to Top”. You can change this setting with the copy User Tools. ⇒ P.312 “General Features”.

To select “Top to Bottom”

❶ Press the [Orientation] key.

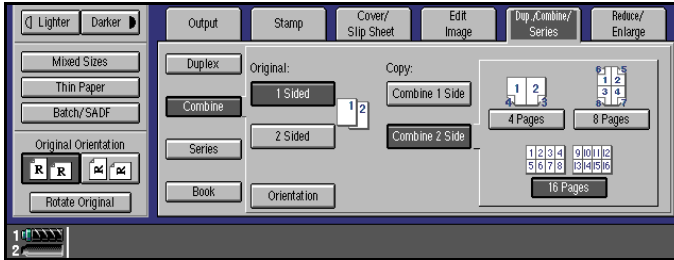

❷ Press the [Top to Bottom] key then press the [OK] key.



❸ Select the paper.

❹ Set your originals then press the [Start] key.

2 Sided 1 Page → Combine 1 Side

Copies one 2-sided original to one side of a sheet.

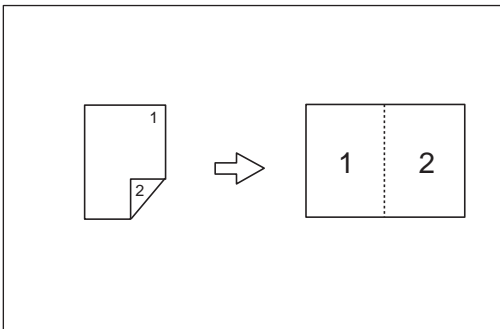

GC3HWYCU

1 Press the [Dup./Combine/Series] key.

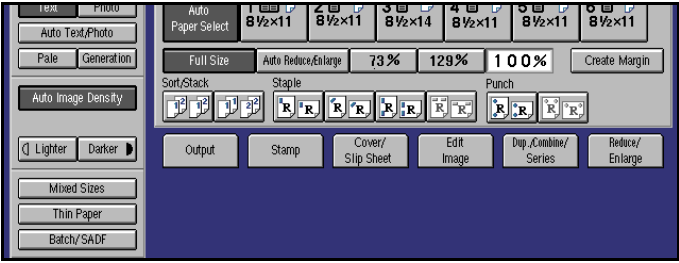

2 Press the [Combine] key.



3 Press the [2 Sided] key for the original, then press the [Combine 1 Side] key for the copy.

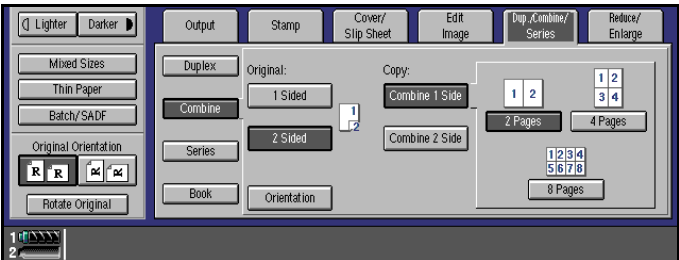

4 Press the [2 Pages] key.

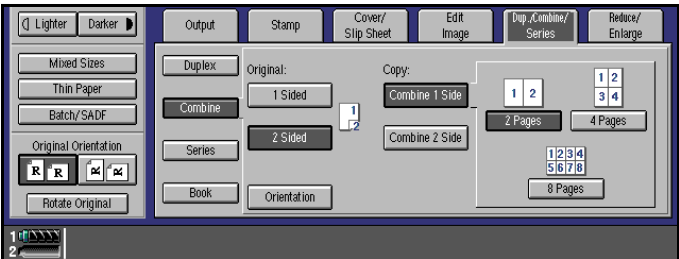

5 Check the orientation.

 **Note**

- To change the copy orientation to “Top to Bottom”, press the [Orientation] key, then press the [Top to Bottom] key. If you do not, go to step 6.

- ❑ The default setting is “Top to Top”. You can change this setting with the copy User Tools. See ⇒ P.312 “General Features”.

To select “Top to Bottom”

- 1 Press the [Orientation] key.

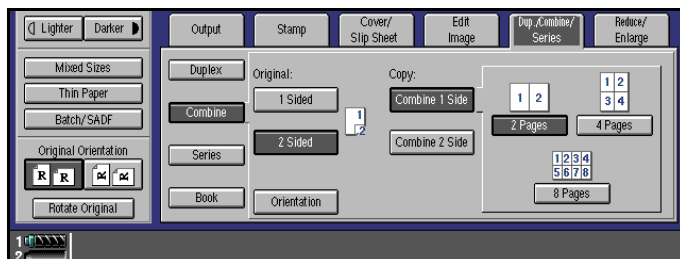

- 2 Press the [Top to Bottom] key then press the [OK] key.

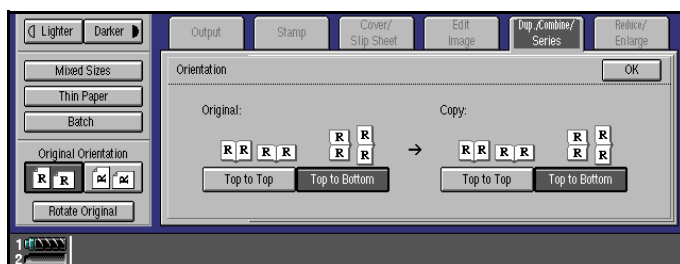

- 6 Select the paper.

- 7 Set your originals then press the [Start] key.

2 Sided 2 Pages → Combine 1 Side

Copies two 2-sided originals to one side of a sheet.

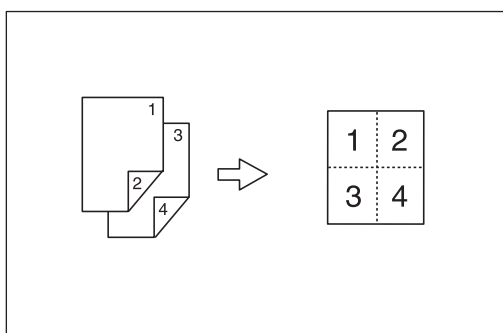

GCSHVYBJ

Note

- ❑ You can change the order that the copy is printed in Combine mode. See ⇒ P.318 “Adjust Image”.

1 Press the [Dup./Combine/Series] key.

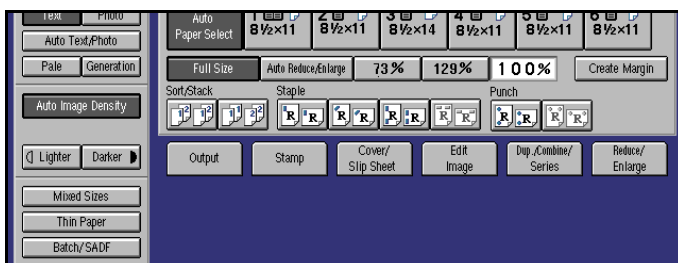

2 Press the [Combine] key.

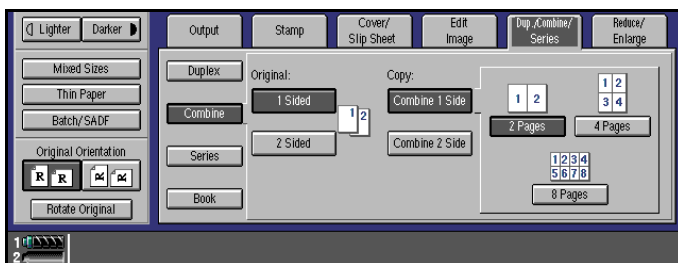

3 Press the [2 Sided] key for the original, then press the [Combine 1 Side] key for the copy.

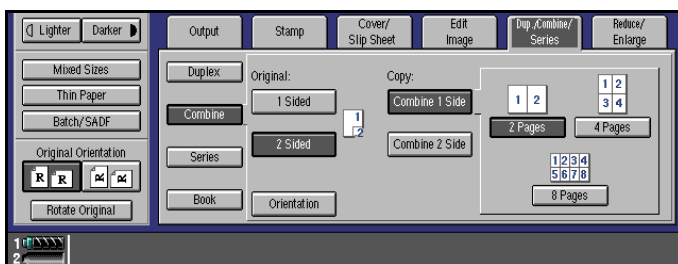

4 Press the [4 Pages] key.

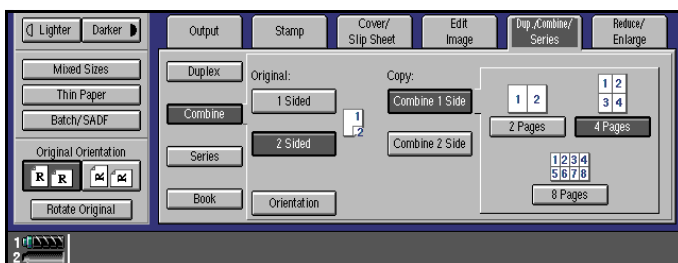

5 Check the orientation.

Note

- To change the copy orientation to "Top to Bottom", press the [Orientation] key, then press the [Top to Bottom] key. If you do not, go to step 6.

- ❑ The default setting is “Top to Top”. You can change this setting with the copy User Tools. See ⇒ P.312 “General Features”.

To select “Top to Bottom”

- 1 Press the [Orientation] key.

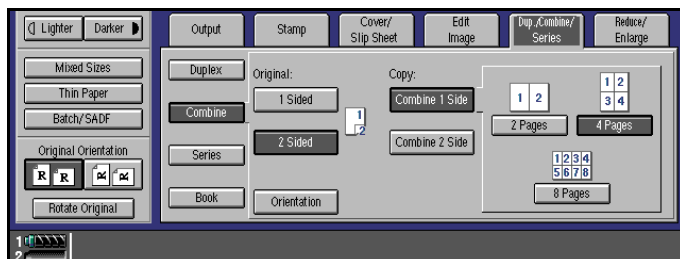

- 2 Press the [Top to Bottom] key then press the [OK] key.

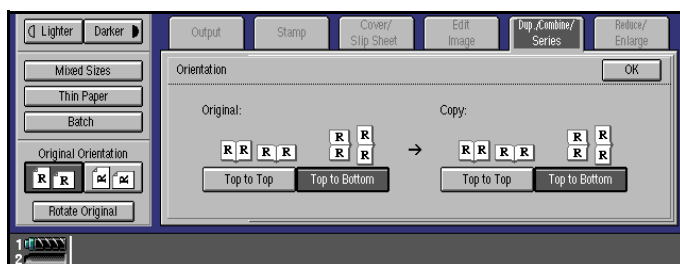

- 6 Select the paper.

- 7 Set your originals then press the [Start] key.

2 Sided 4 Pages → Combine 1 Side

Copies four 2-sided originals to one side of a sheet.

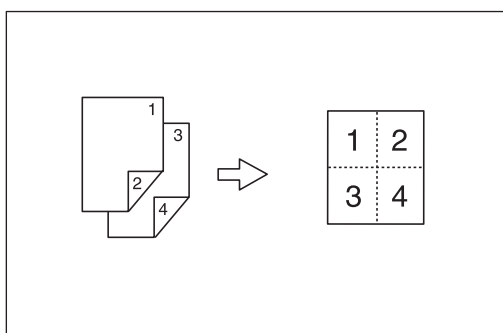

GCSHVYBJ

Note

- ❑ You can change the order that the copy is printed in Combine mode. See ⇒ P.318 “Adjust Image”.

1 Press the [Dup./Combine/Series] key.

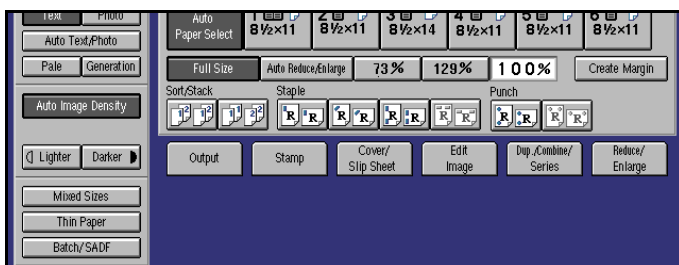

2 Press the [Combine] key.

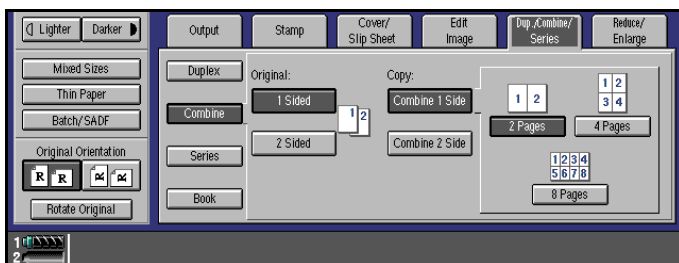

3 Press the [2 Sided] key for the original, then press the [Combine 1 Side] key for the copy.

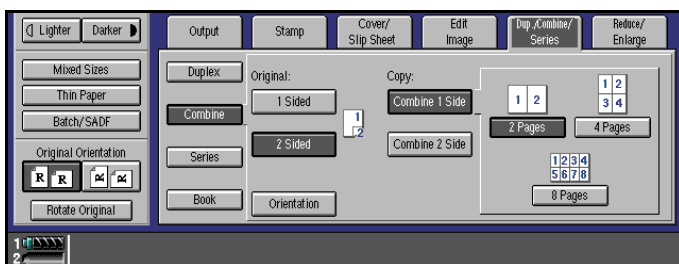

4 Press the [8 Pages] key.

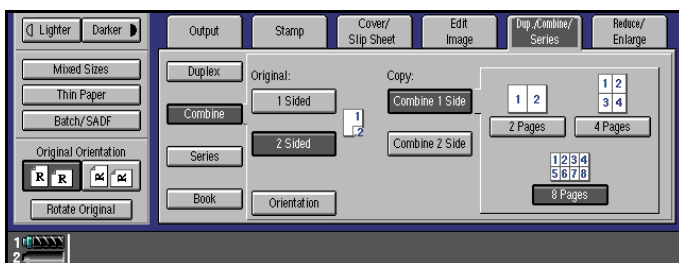

5 Check the orientation.

Note

- To change the copy orientation to "Top to Bottom", press the [Orientation] key, then press the [Top to Bottom] key. If you do not, go to step 6.

- ❑ The default setting is “Top to Top”. You can change this setting with the copy User Tools. See ⇒ P.312 “General Features”.

To select “Top to Bottom”

- 1 Press the [Orientation] key.

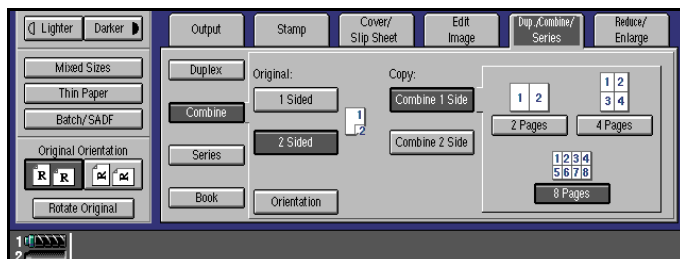

- 2 Press the [Top to Bottom] key then press the [OK] key.

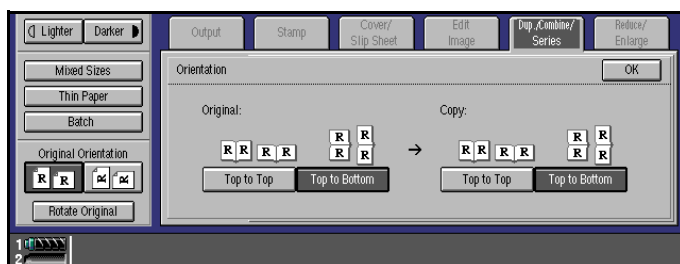

- 6 Select the paper.

- 7 Set your originals then press the [Start] key.

2 Sided 2 Pages → Combine 2 Side

Copies 2-sided originals together to both sides of a sheet.

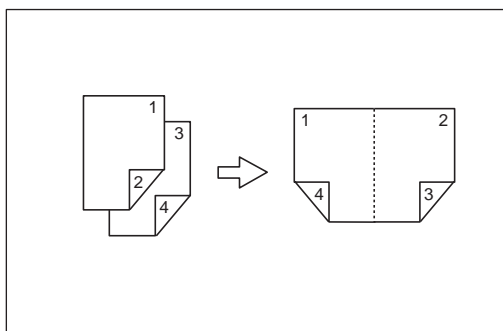

GC294Y13

1 Press the [Dup./Combine/Series] key.

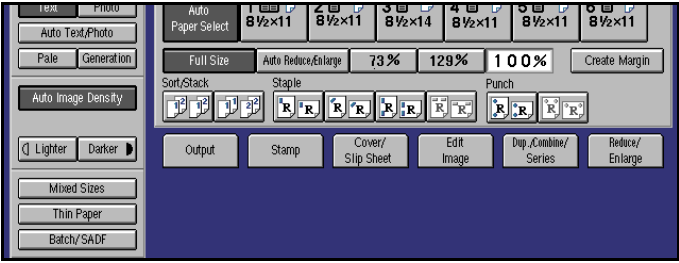

2 Press the [Combine] key.

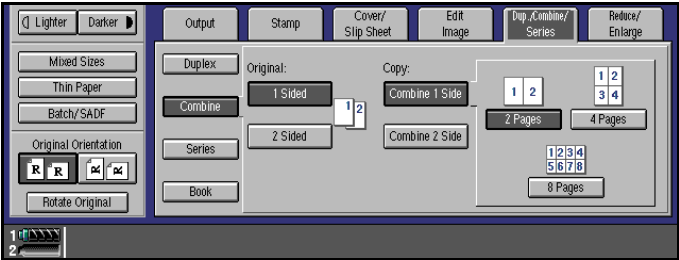

3 Press the [2 Sided] key for the original, then press the [Combine 2 Side] key for the copy.

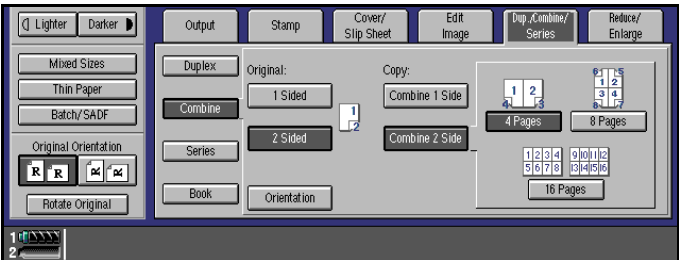

4 Press the [4 Pages] key.

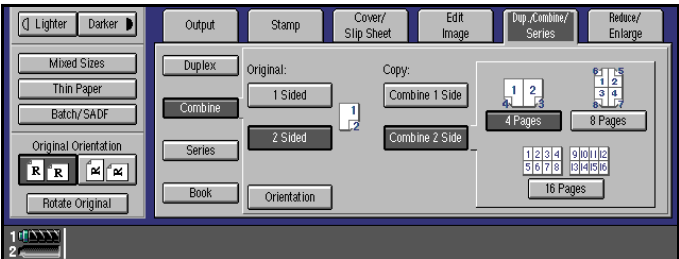

5 Check the orientation.

 **Note**

- To change the copy orientation to “Top to Bottom”, press the [Orientation] key, then press the [Top to Bottom] key. If you do not, go to step 6.

- The default setting is “Top to Top”. You can change this setting with the copy User Tools. See ⇒ P.312 “General Features”.

To select “Top to Bottom”

- 1 Press the [Orientation] key.



- 2 Press the [Top to Bottom] key then press the [OK] key.

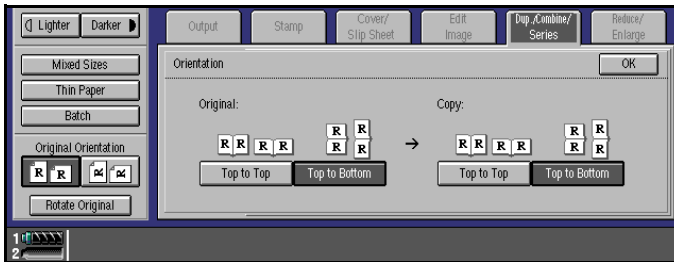

- 6 Select the paper.

- 7 Set your originals then press the [Start] key.

2 Sided 4 Pages → Combine 2 Side

Copies four 2-sided originals together to both sides of a sheet.

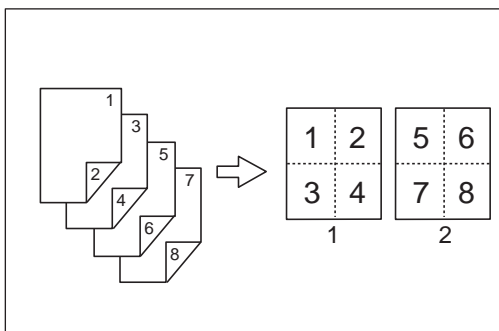

GCSHVY2E

1. Front
2. Back

Note

- You can change the order that the copy is printed in Combine mode. See ⇒ P.318 “Adjust Image”.

1 Press the [Dup./Combine/Series] key.

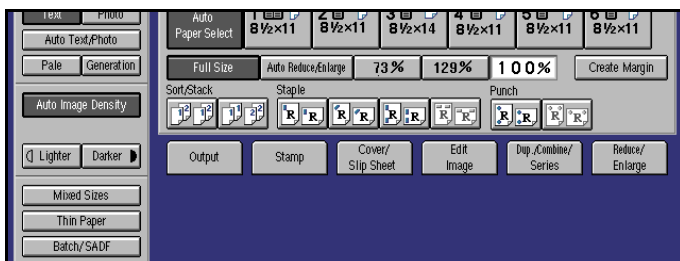

2

2 Press the [Combine] key.

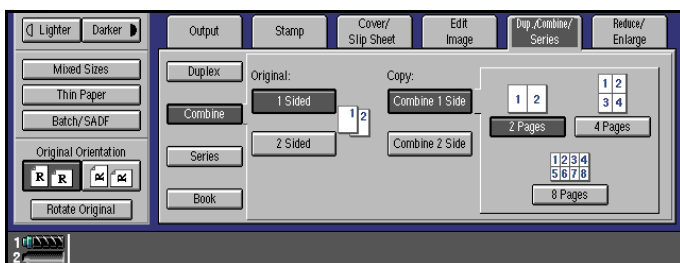

3 Press the [2 Sided] key for the original, then press the [Combine 2 Side] key for the copy.

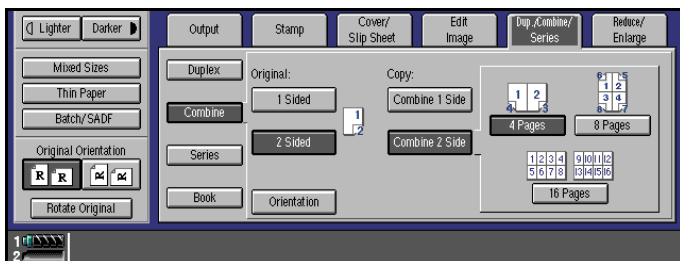

4 Press the [8 Pages] key.

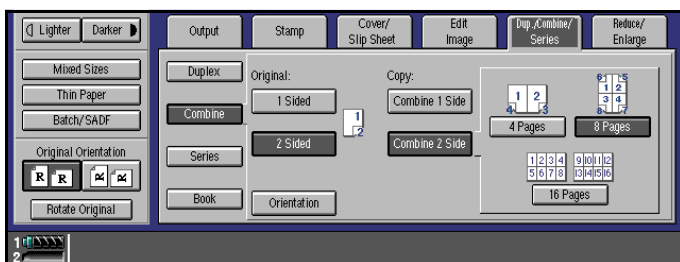

5 Check the orientation.

Note

- To change the copy orientation to “Top to Bottom”, press the **[Orientation]** key, then press the **[Top to Bottom]** key. If you do not, go to step **6**.
- The default setting is “Top to Top”. You can change this setting with the copy User Tools. See ⇒ P.312 “General Features”.

To select “Top to Bottom”

2

1 Press the **[Orientation]** key.**2** Press the **[Top to Bottom]** key then press the **[OK]** key.**6** Select the paper.**7** Set your originals then press the **[Start]** key.

2 Sided 8 Pages → Combine 2 Side

Copies eight 2-sided originals together to both sides of a sheet.

2

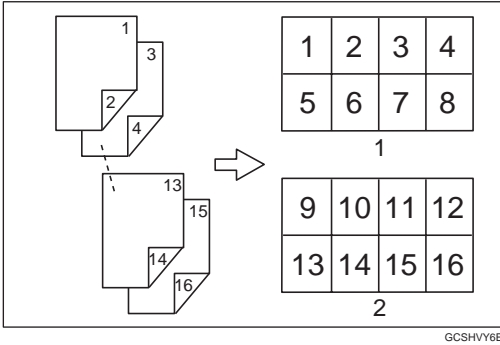

1. Front

2. Back

Note

- You can change the order that the copy is printed in Combine mode. See ⇒ P.318 “Adjust Image”.

1 Press the [Dup./Combine/Series] key.

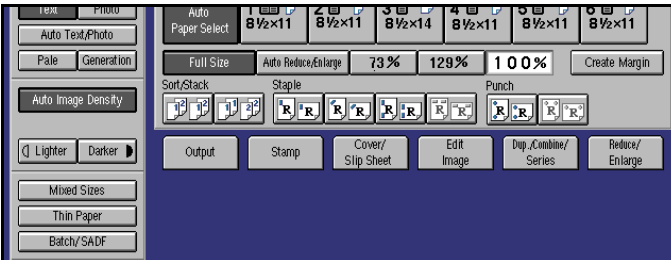

2 Press the [Combine] key.

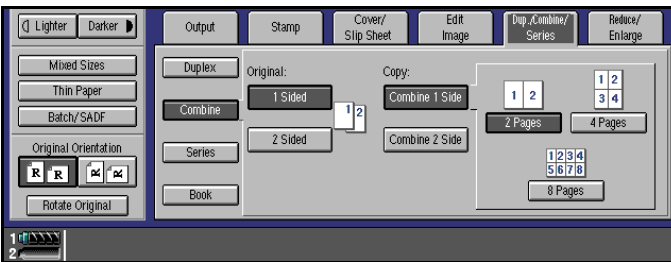

3 Press the [2 Sided] key for the original, then press the [Combine 2 Side] key for the copy.

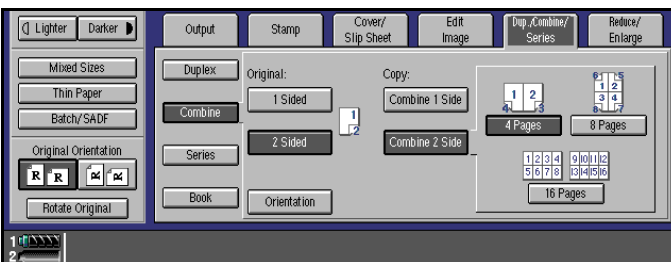

4 Press the [16 Pages] key.

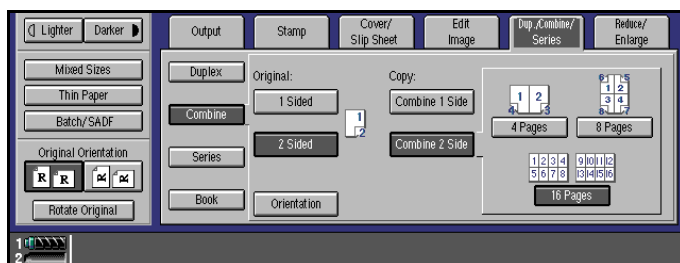

2

5 Check the orientation.

Note

- To change the copy orientation to “Top to Bottom”, press the [Orientation] key, then press the [Top to Bottom] key. If you do not, go to step 6.
- The default setting is “Top to Top”. You can change this setting with the copy User Tools. See ⇒ P.312 “General Features”.

To select “Top to Bottom”

1 Press the [Orientation] key.

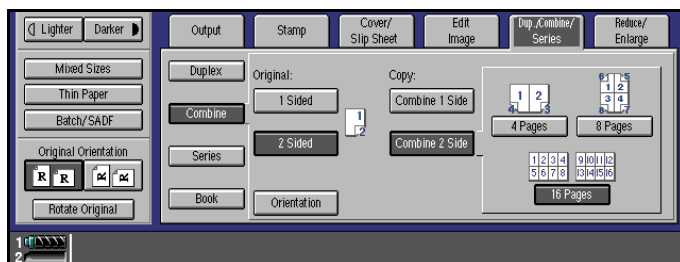

2 Press the [Top to Bottom] key then press the [OK] key.

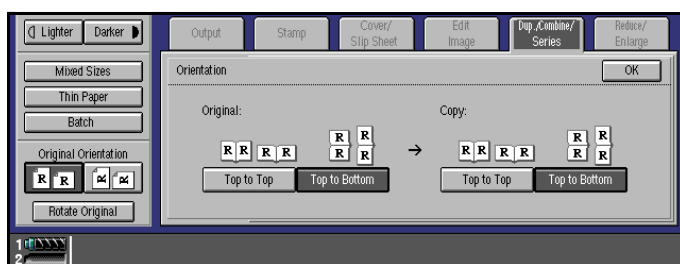

6 Select the paper.

7 Set your originals then press the [Start] key.

Series Copies

Series copies are made by separately copying the front and back of a 2-sided original or the two facing pages of a spread original onto two sheets of paper.

Two varieties of this feature are available:

❖ 2 Sided → 1 Sided

Copies the front and back of a 2-sided original to make two 1-sided copies.

❖ Book → 1 Sided

Copies the two facing pages of a spread original to make two 1-sided copies.

2 Sided→1 Sided

Use this function to make one-sided copies from two-sided originals.

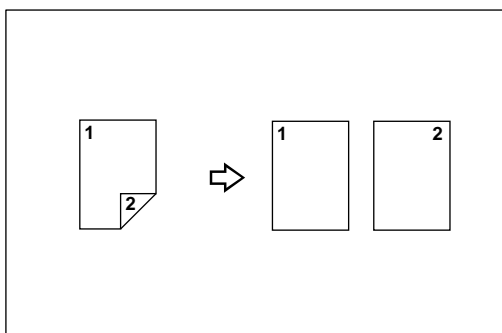

1 Press the [Dup./Combine/Series] key.

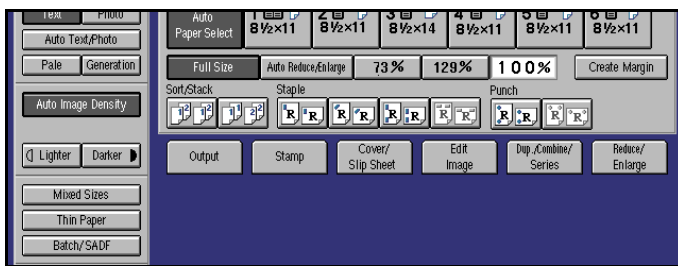

2 Press the [Series] key.

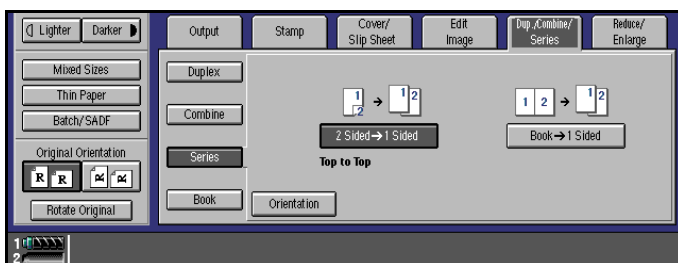

2

3 Press the [2 Sided → 1 Sided] key.

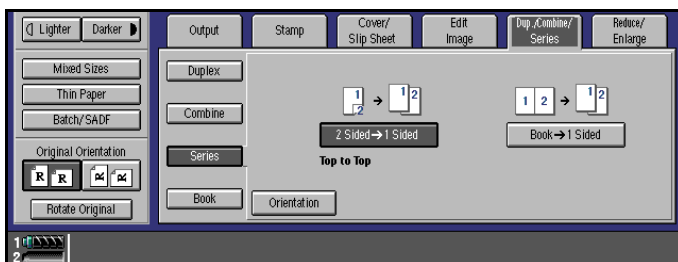

4 Check the orientation.

Note

- To change the copy orientation to “Top to Bottom”, press the [Orientation] key, then press the [Top to Bottom] key. If you do not, go to step 6.
- The default setting is “Top to Top”. You can change this setting with the copy User Tools. See ⇒ P.312 “General Features”.

To select “Top to Bottom”

1 Press the [Orientation] key.

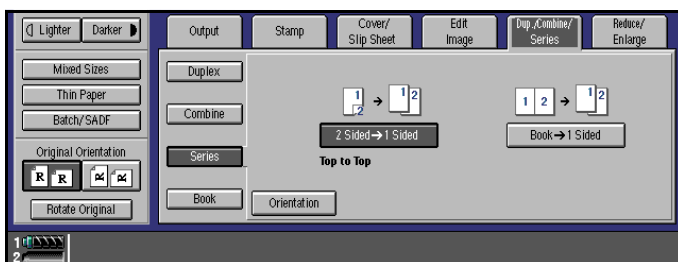

2 Press the [Top to Bottom] key then press the [OK] key.



5 Set your originals then press the [Start] key.

Book → 1 Sided

Use this function to make one-sided copies from two facing pages of a bound original, e.g., a book or magazine.

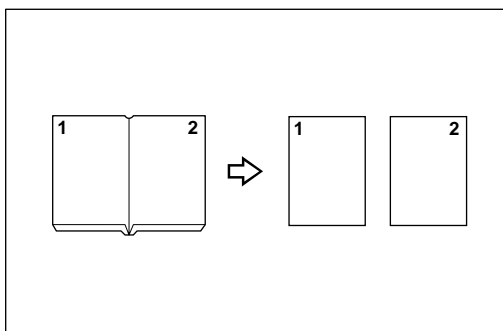

Note

Refer to the following table when you select original and copy paper sizes with a 100 % ratio:

◆ Metric version

Original	Copy paper
A3	A4 × 2 sheets
B4	B5 × 2 sheets
A4	A5 × 2 sheets

◆ Inch version

Original	Copy paper
11" × 17"	8 ¹ / ₂ " × 11" × 2 sheets
8 ¹ / ₂ " × 11"	5 ¹ / ₂ " × 8 ¹ / ₂ " × 2 sheets

1 Press the [Dup./Combine/Series] key.

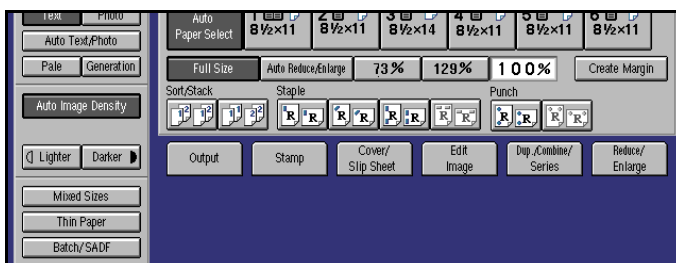

2 Press the [Series] key.

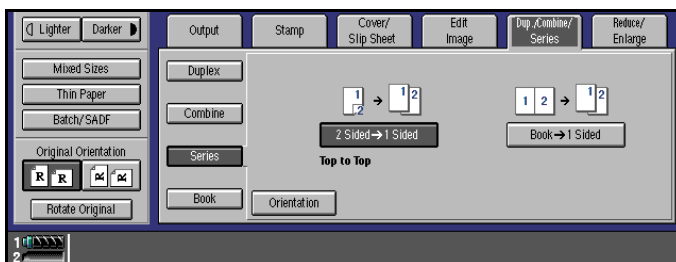

3 Press the [Book → 1 Sided] key.

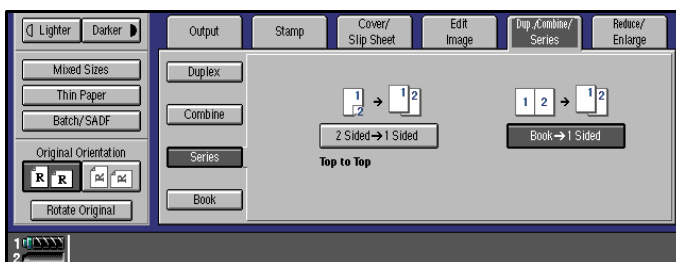

4 Make sure that [Auto Paper Select] is selected.

5 Set the book on the exposure glass, then press the [Start] key.

2

Copying Book Originals

A book is made by copying two or more originals in page order.

❖ **Book → 2 Sided**

Copies a two-page spread original onto both sides of a sheet.

❖ **Multi → 2 Sided**

Copies each two-page spread original as it is onto both sides of a sheet.

❖ **Booklet**

Make copies in page order for a folded booklet.

❖ **Magazine**

Copies two or more originals to make copies in page order (for when they are folded and stacked).

💡 **Limitation**

The machine cannot copy originals different in size and direction.

📝 **Note**

The machine sets the reproduction ratio automatically to match the paper size and copies the originals together onto the paper.

The machine uses ratios in the range of 25 to 400 %.

If the calculated ratio is under the available minimum ratio, it will be adjusted to the minimum ratio. However, with some ratios parts of the image might not be copied.

Even if the direction of originals is different from that of the copy paper, the machine will automatically rotate the image by 90° to make copies properly.

Book→2 Sided

Copies a two-page spread original onto both sides of a sheet.

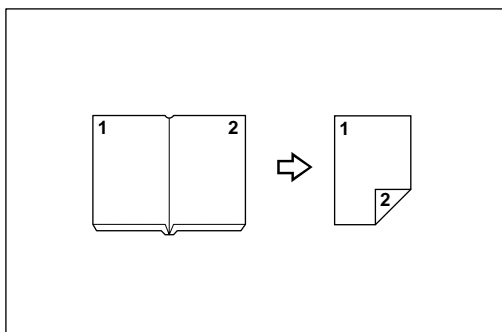

Note

- Refer to the following table when you select original and copy paper sizes with a 100 % ratio:

❖ Metric version

Original	Copy Paper
A3	A4 (2-sided)
B4	B5 (2-sided)
A4	A5 (2-sided)

❖ Inch version

Original	Copy Paper
11" × 17"	8½" × 11" (2-sided)
8½" × 11"	5½" × 8½" (2-sided)

1 Press the [Dup./Combine/Series] key.

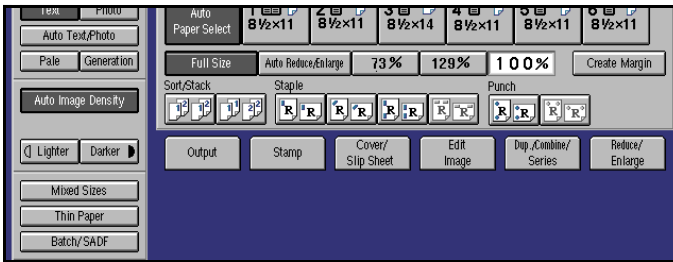

2 Press the [Book] key.

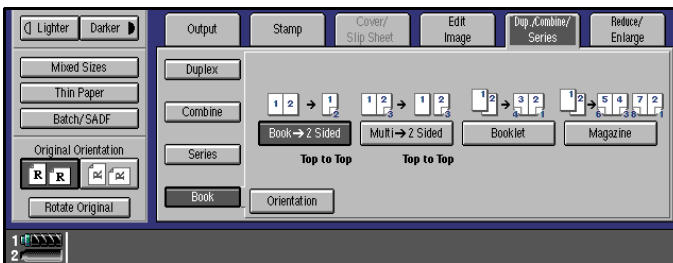

3 Press the [Book → 2 Sided] key.

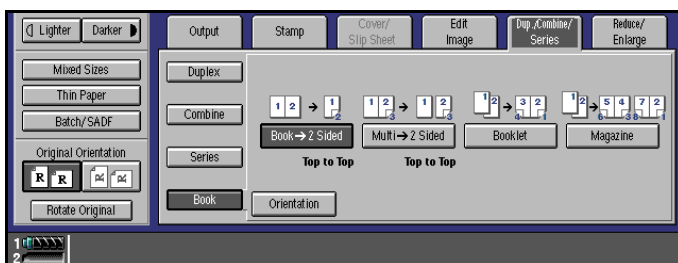

4 Check the orientation.

Note

- To change the copy orientation to “Top to Bottom”, press the [Orientation] key, then press the [Top to Bottom] key. If you do not, go to step 6.
- The default setting is “Top to Top”. You can change this setting with the copy User Tools. See ⇒ P.312 “General Features”.

To select “Top to Bottom”

1 Press the [Orientation] key.



2 Press the [Top to Bottom] key then press the [OK] key.

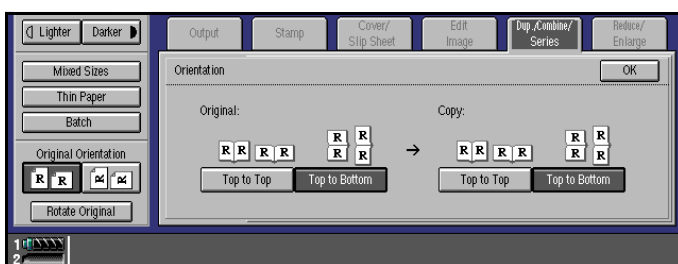

5 Set the book on the exposure glass, then press the [Start] key.

Multi → 2 Sided

Copies each two-page spread original as it is onto both sides of a sheet.

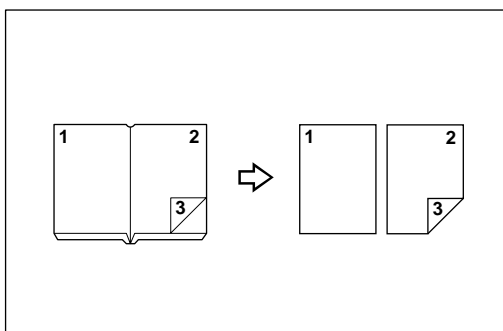

2

Note

- Refer to the following table when you select original and copy paper sizes with a 100 % ratio:

❖ **Metric version**

Original	Copy paper
A3	A4 (2-sided)
B4	B5 (2-sided)
A4	A5 (2-sided)

❖ **Inch version**

Original	Copy paper
11" × 17"	8 ¹ / ₂ " × 11" (2-sided)
8 ¹ / ₂ " × 11"	5 ¹ / ₂ " × 8 ¹ / ₂ " (2-sided)

1 Press the [Dup./Combine/Series] key.

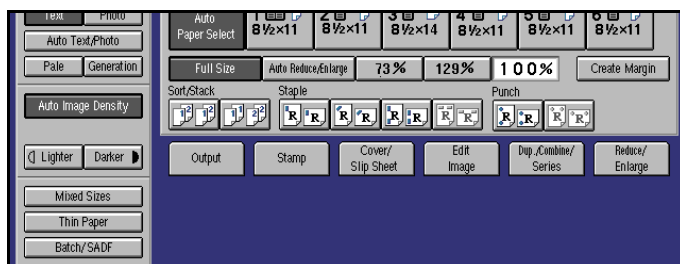

2 Press the [Book] key.

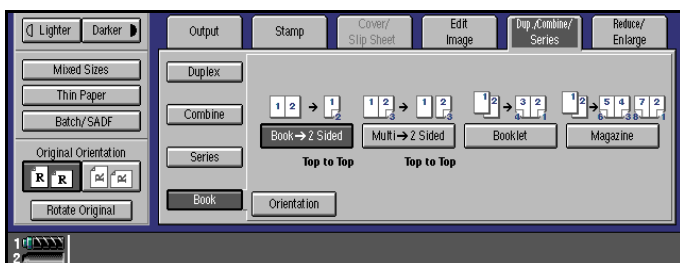

3 Press the [Multi → 2 Sided] key.

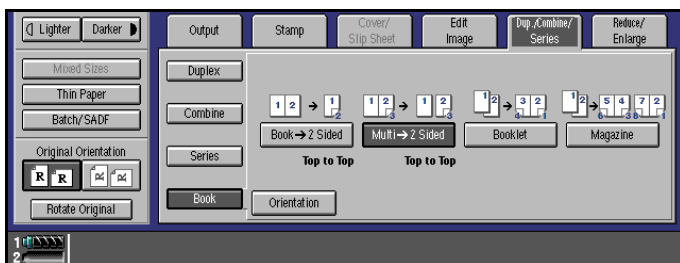

4 Check the orientation.

Note

- To change the copy orientation to “Top to Bottom”, press the [Orientation] key, then press the [Top to Bottom] key. If you do not, go to step 6.
- The default setting is “Top to Top”. You can change this setting with the copy User Tools. See ⇒ P.312 “General Features”.

To select “Top to Bottom”

1 Press the [Orientation] key.



2 Press the [Top to Bottom] key then press the [OK] key.

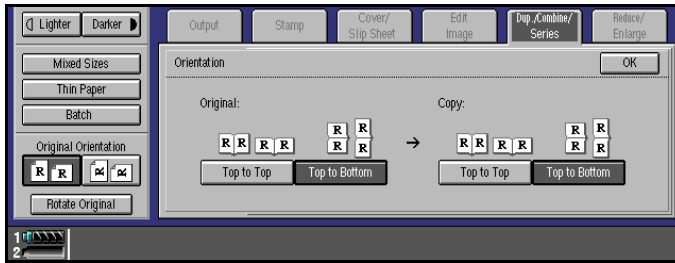

2

5 Select the paper.

6 Set your originals then press the [Start] key.

Note

- When placing one original on the exposure glass or in the document feeder in Batch (SADF) mode, press the [#] key at the last original.

Booklet

Make copies in page order for a folded booklet as shown in the following illustrations:

❖ **Forward**

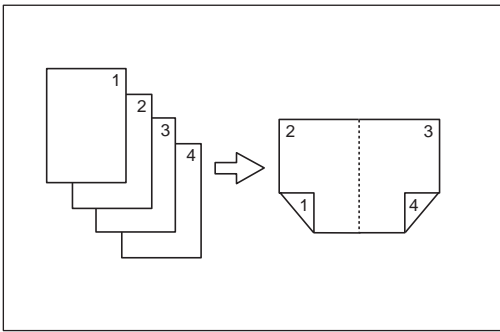

GCB00K0E

❖ **Backward**

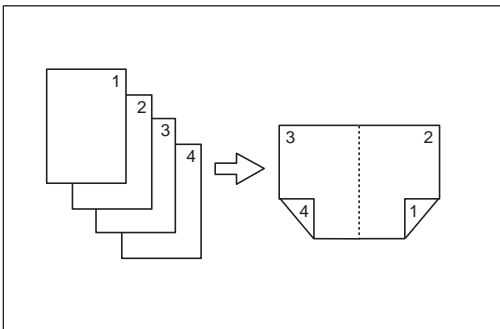

GCB00K1E

Important

- ❑ Before selecting this function, select “Forward” or “Backward” with the User Tools. See “Copy Orientation In Booklet/Magazine” ⇒ P.318 “Adjust Image”.

Note

- ❑ Four originals are copied onto each sheet of copy paper.
- ❑ In this mode, the machine sets the reproduction ratio automatically to match the paper size and copies the originals together onto the paper.
- ❑ A ratio is selected in the range of 25 to 400 %.
- ❑ If the calculated ratio is under the available minimum ratio, it will be adjusted to the minimum ratio. However, with some ratios, parts of the image might not be copied.
- ❑ If the number of originals scanned is less than a multiple of 4, the last page is copied blank.

2

How to fold copies to make a booklet

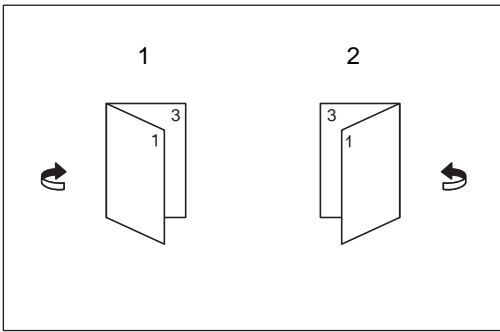

GCBOOK2E

1. Forward

2. Backward

1 Press the [Dup./Combine/Series] key.

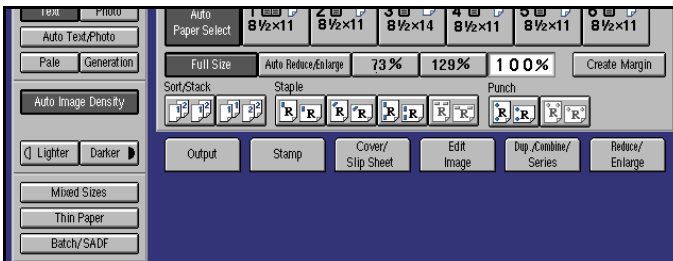

2 Press the [Book] key.

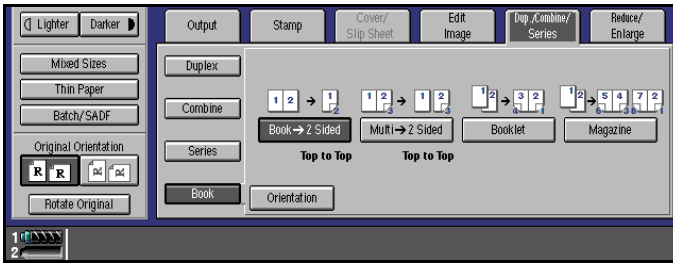

2

3 Press the [Booklet] key.

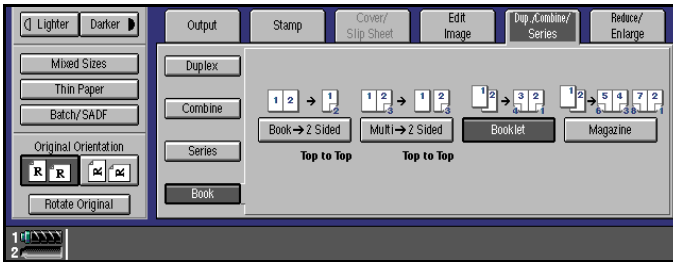

4 Select the paper.

5 Set your originals then press the [Start] key.

Magazine

Copies two or more originals to make copies in page order when they are folded and stacked.

❖ Forward

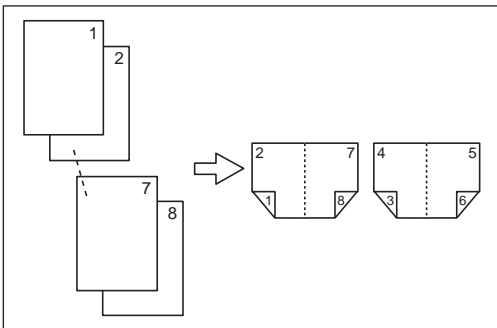

GCBOOK3E

❖ **Backward**

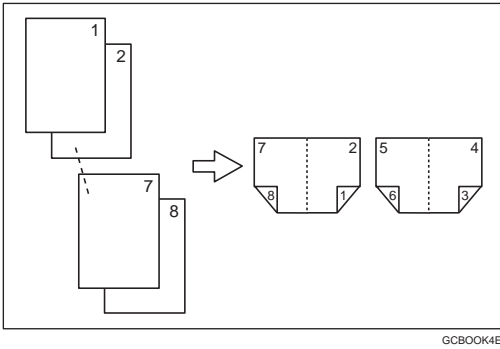

GCBOOK4E

Important

- ❑ Before selecting this function, select “ **[Forward]** ” or “ **[Backward]** ” with the User Tools. See “Copy Orientation In Booklet/Magazine” ⇒ P.318 “Adjust Image”.

Note

- ❑ Four originals are copied onto each sheet of copy paper.
- ❑ In this mode, the machine sets the reproduction ratio automatically to match the paper size and copies the originals together onto the paper.
- ❑ A ratios selected in the range of 25 to 400 %.
- ❑ If the calculated ratio is under the available minimum ratio, it will be adjusted to the minimum ratio. However, with some ratios, parts of the image might not be copied.
- ❑ If the number of originals scanned is less than a multiple of 4, the last page is copied blank.

How to fold copies to make a magazine

❖ **Forward**

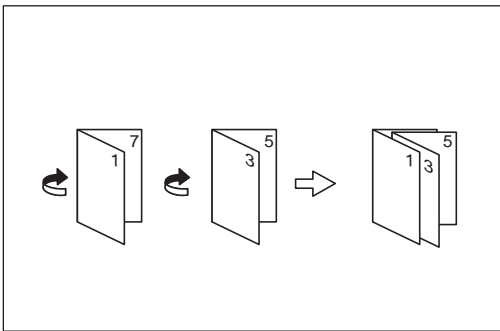

GCBOOK5E

❖ **Backward**

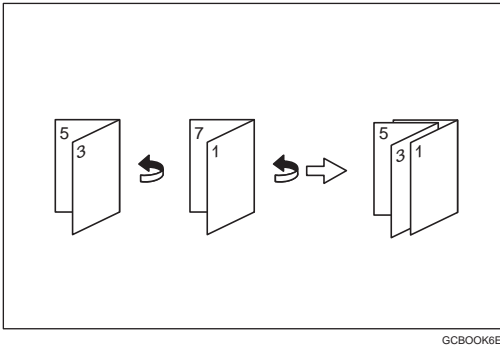

1 Press the [Dup./Combine/Series] key.

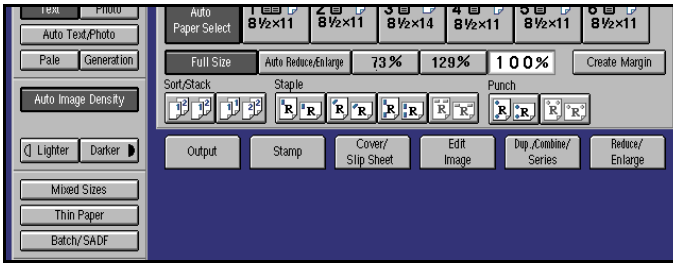

2 Press the [Book] key.



3 Press the [Magazine] key.

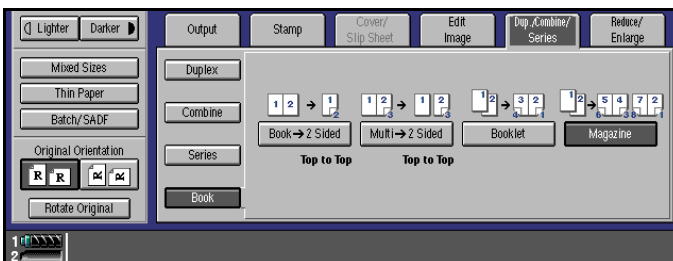

4 Select the paper.

5 Set your originals then press the [Start] key.

Note

- ☐ The copying may take some time after scanning originals.

Margin Adjustment

You can shift the image left, right, top or bottom to make a binding margin.

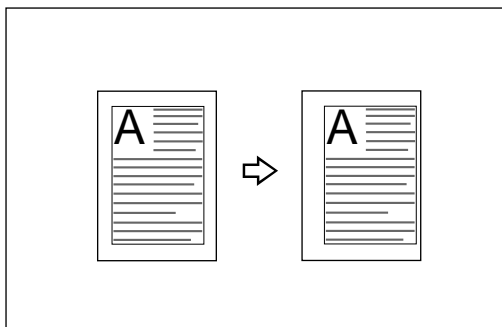

2

! Limitation

- If you set too wide a margin, areas you do not want to delete might be erased.

📝 Note

- You can change the width of the binding margin as follows:

Metric version	0 – 30 mm (in 1 mm steps)
Inch version	0" – 1.2" (in 0.1" steps)

- The margin width default is as follows. You can change this default setting with the User Tools. See “Front Margin: Left/Right” “Back Margin: Left/Right” “Front Margin: Top/Bottom” “Back Margin: Top/Bottom” ⇒ P.318 “Adjust Image”.

Metric version	<ul style="list-style-type: none"> • Front: 5 mm Left • Back: 5 mm Right
Inch version	<ul style="list-style-type: none"> • Front: 0.2" Left • Back: 0.2" Right

- When making two-sided copies from one-sided originals, you can set a binding margin for back pages. See “1 → 2 Duplex Auto Margin Adjust” ⇒ P.318 “Adjust Image”.

1 Press the [Edit Image] key.

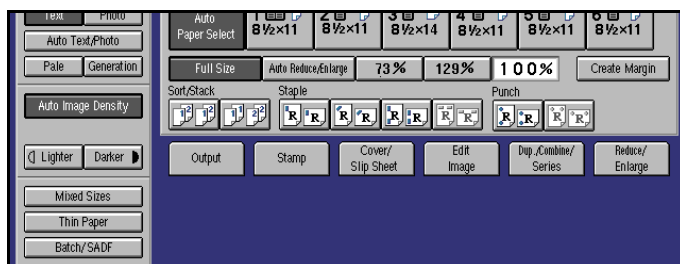

2 Press the [Margin Adj.] key.

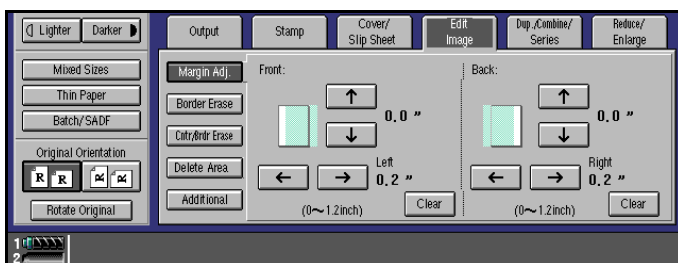

3 Set a front margin for a front page. Press the [→] and [←] keys when setting the left and right margins, and the [↓] and [↑] keys when setting the top and bottom margins.

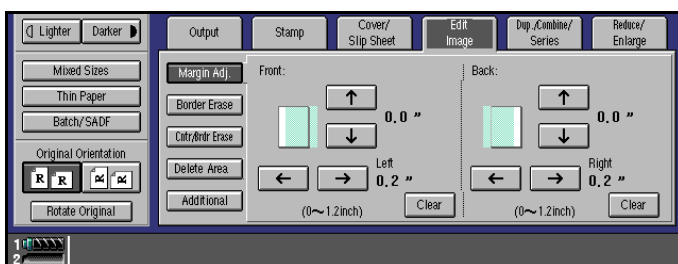

Note

- You can adjust the width in the range of 3–50mm, 0,1"–2,0".

4 Set a back margin the back page. Press the [→] and [←] keys when setting the left and right margins, and the [↓] and [↑] keys when setting the top and bottom margins.

Note

- You can specify the back margin only when the Duplex or the Two Sided copy with Combine is selected.
- If you do not set a back margin, go to step **5**.

5 Set your originals then press the [Start] key.

Border Erase

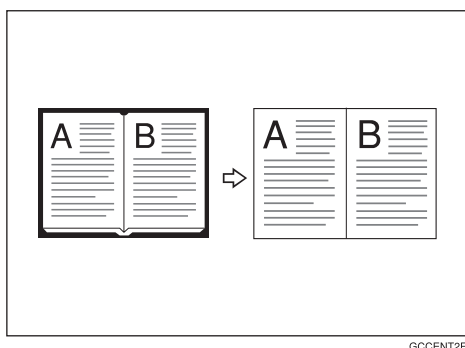

GCENT2E

! Limitation

- This function will not take effect if the size of the original cannot be detected.

✎ Note

- You can change the width of the erased margin as follows:

Metric version	3 – 50 mm (in 1 mm steps)
Inch version	0.1" – 2.0" (in 0.1" steps)

✎ Note

- The default width of the erased margin is as follows. You can change this settings with the User Tools. See "Border Erase Width" ⇒ P.318 "Adjust Image"

Metric version	10 mm
Inch version	0.4"















- .
- The width of the erased margin varies depending on the reproduction ratio.
- If the size of the original is different from sizes listed in the following chart, the erased margin might be shifted.

◆ Metric version

Where Original Is Set	Paper Size and Orientation
Exposure glass	A3☐, B4☐, A4☐☐, B5☐☐, 8 ¹ / ₂ " × 13"☐ *1
Document feeder	A3☐, B4☐, A4☐☐, B5☐☐, A5☐☐, B6☐☐, 11" × 17"☐, 11" × 15"☐, 8 ² / ₁ " × 11"☐☐, 8 ¹ / ₂ " × 13"☐ *1

*1 You can select from 8¹/₂" × 13", 8¹/₄" × 13" and 8" × 13" with the User Tools (System Settings). See "Original: F/F4 Size Setting" in the System Settings manual.

❖ Inch version

Where Original Is Set	Paper Size and Orientation
Exposure glass	11" × 17"  , 8 1/2" × 14"  , 8 1/2" × 11"  
Document feeder	A4   , 11" × 17"  , 11" × 15"  , 8 1/2" × 14"  , 8 1/2" × 11"   , 5 1/2" × 8 1/2"   , 8 1/2" × 13"  *1 1

*1 You can select from 8 1/2" × 13", 8 1/4" × 13" and 8 " × 13" with the User Tools (System Settings). See "Original: F/F4 Size Setting" in the System Settings manual.

- The position of the margin to be erased is determined according to the original size and reproduction ratio.

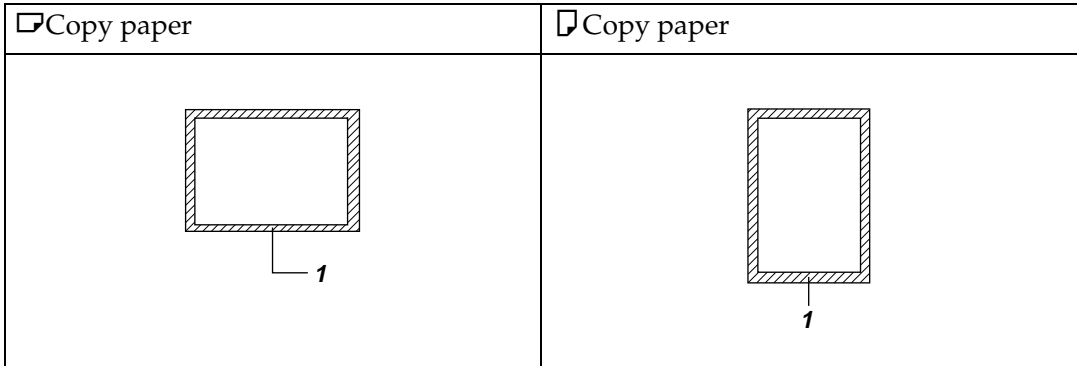

- 1: Erased part

1 Press the [Edit Image] key.

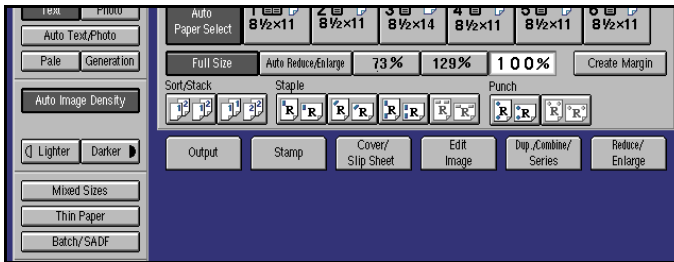

2 Press the [Border Erase] key.

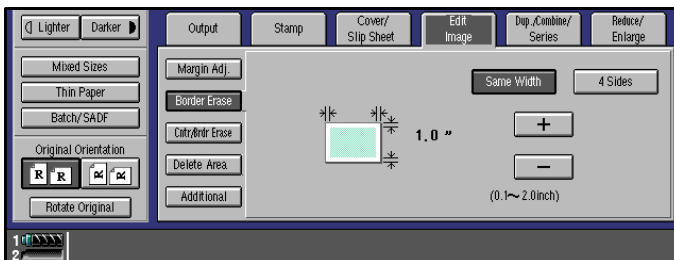

To select “Same Width”

- 1 Press the **[Same Width]** key.

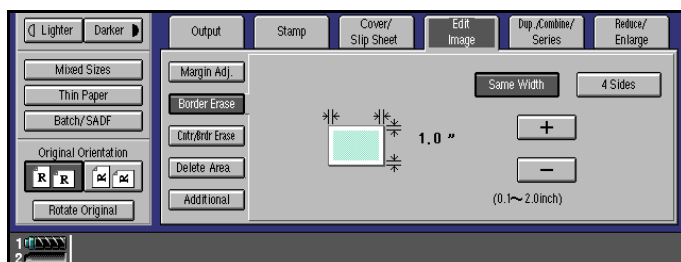

- 2 Adjust the width of the margin to be erased by pressing the **[+]** or **[-]** key.

 **Note**

- To change the width entered, press the **[+]** and **[-]** keys and enter the correct width.

To Select “4 Sides”

- 1 Press the **[4 Sides]** key.

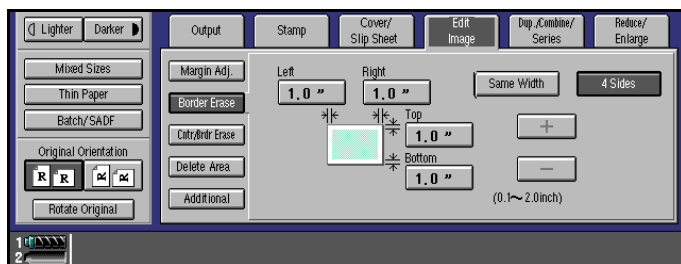

- 2 Adjust the width of the margin to be erased by pressing the **[+]** or **[-]** key.

 **Note**

- To change the width entered, press the **[+]** and **[-]** keys and enter the correct width.

- 3 Set your originals then press the **[Start]** key.

Center/Border Erase

This function erases the center and/or all four sides of the original image. This is useful for avoiding shadows on the copy image caused by the binding or splayed pages of books etc.

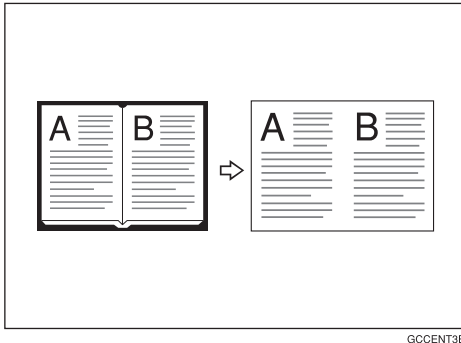

GCCENT3E

Two modes of this feature are available:

❖ Center

This mode erases the Center margin of the original image.

❖ Border

This mode erases the edges area of the original image.

📌 Limitation

- This function will not take effect if the size of the original cannot be detected.

📝 Note

- You can change the width of the erased margin as follows:

Metric version	3 – 50 mm (in 1 mm steps)
Inch version	0.1" – 2.0" (in 0.1" steps)

- The default width of the erased margin is as follows. You can change this settings with the User Tools. See "Border Erase Width" ⇒ P.318 "Adjust Image" and "Centre Erase Width" ⇒ P.318 "Adjust Image".

Metric version	10 mm
Inch version	0.4"

- The width of the erased margin varies depending on the reproduction ratio.
- If the size of the original is different from sizes listed in the following chart, the erased margin might be shifted.

❖ Metric version

Where Original Is Set	Paper Size and Orientation
Exposure glass	A3, B4, A4, B5, 8 ¹ / ₂ " × 13" *1
Document feeder	A3, B4, A4, B5, A5, B6, 11" × 17", 11" × 15", 8 ² / ₁ " × 11", 8 ¹ / ₂ " × 13" *1

*1 You can select from 8¹/₂" × 13", 8¹/₄" × 13" and 8" × 13" with the User Tools (System Settings). See "Original: F/F4 Size Setting" in the System Settings manual.

❖ Inch version

Where Original Is Set	Paper Size and Orientation
Exposure glass	11" × 17", 8 ¹ / ₂ " × 14", 8 ¹ / ₂ " × 11"
Document feeder	A4, 11" × 17", 11" × 15", 8 ¹ / ₂ " × 14", 8 ¹ / ₂ " × 11", 5 ¹ / ₂ " × 8 ¹ / ₂ ", 8 ¹ / ₂ " × 13" *1

*1 You can select from 8¹/₂" × 13", 8¹/₄" × 13" and 8" × 13" with the User Tools (System Settings). See "Original: F/F4 Size Setting" in the System Settings manual.

- ☐ The position of the margin to be erased is determined according to the original size and reproduction ratio.

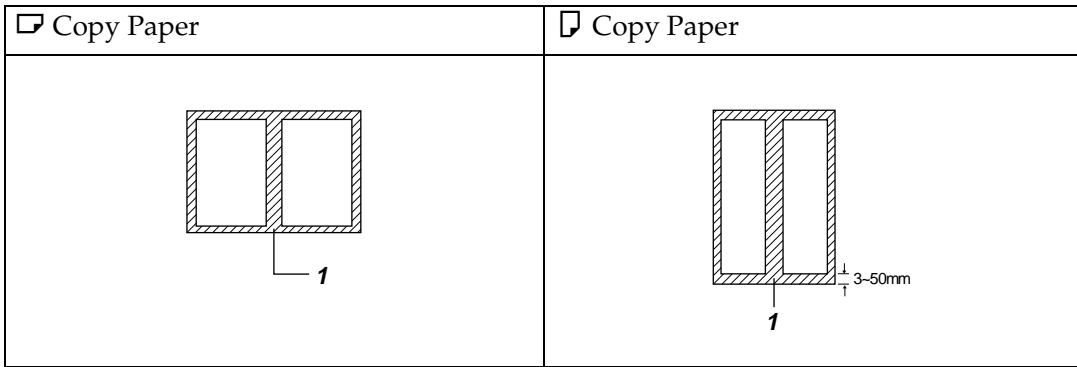

- ☐ 1: Erased part
- ☐ You can use the Erase Center and Erase Border functions together.

1 Press the [Edit Image] key.

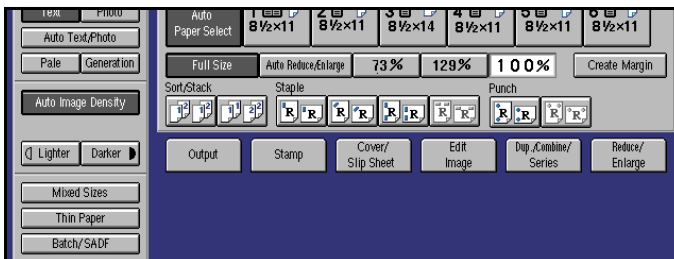

2 Press the [Ctr/Brdr Erase] key.

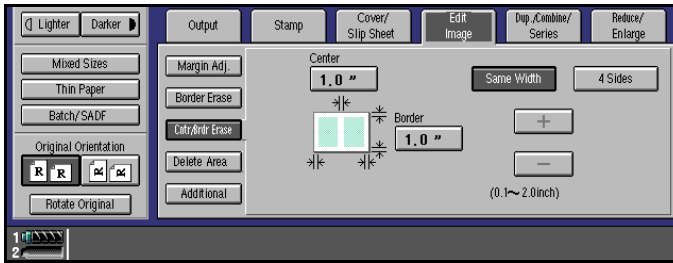

Selecting “Same Width”

1 Press the [Same Width] key.

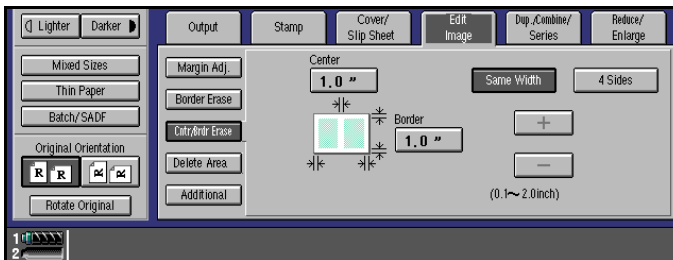

2 Set the width with the [+] and [-] keys.

Note

- To change the width entered, press the [+] and [-] keys and enter the correct width.

Selecting “4 Sides”

1 Press the [4 Sides] key.

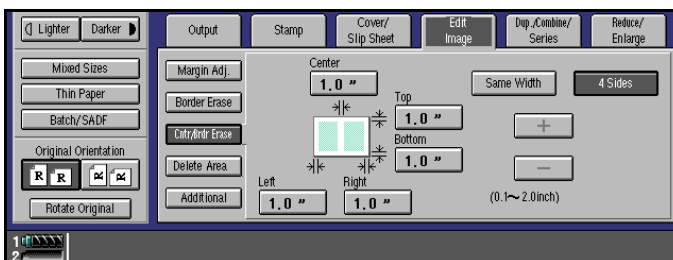

2 Set the width with the [+] and [-] keys.

Note

- To change the width entered, press the [+] and [-] keys and enter the correct width.

3 Set your originals then press the [Start] key.

Delete Area

Delete Inside

This function blanks out a designated area of the copy image.

2

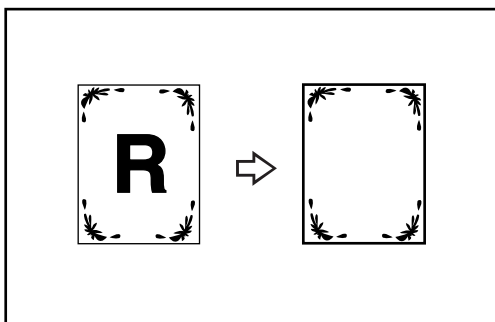

Note

- The length you can input is 0-450mm.
- You can erase two parts of the image at a same time.

1 Press the [Edit Image] key.

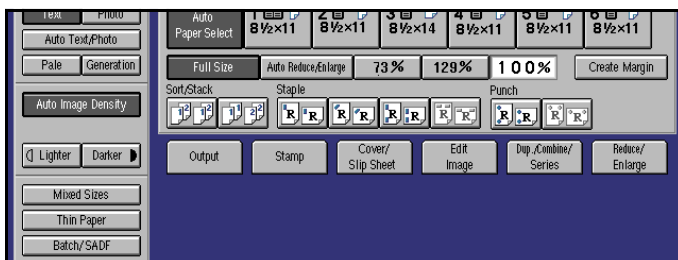

2 Press the [Delete Area] key.

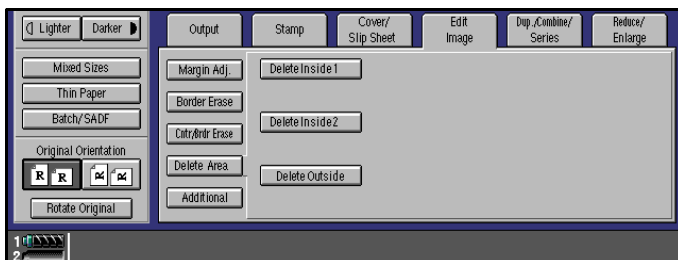

3 Press the [Delete Inside 1] or [Delete Inside 2] key.

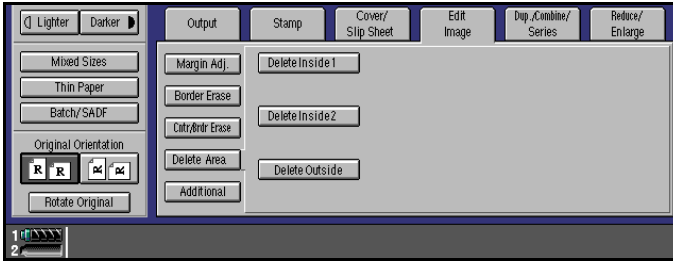

4 Input the value of X1, then press the [#] key or [X2] key.

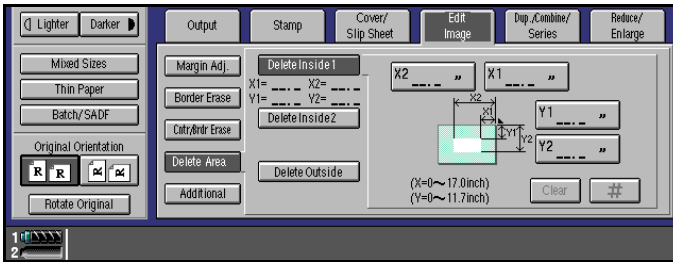

Note

- To change the length entered, press the [Clear] key on the control panel or [Clear] key on the display panel and enter the new length.

5 Input the value of X2, then press the [#] key or [Y1] key.

6 Input the value of Y1, then press the [#] key or [Y2] key.

7 Input the value of Y2, then press the [#] key.

Note

- To change the number entered, press the item that you want to change and enter the new number.

8 Set your originals then press the [Start] key.

2

Delete Outside

This function blanks out all areas of the copy image except the area you choose.

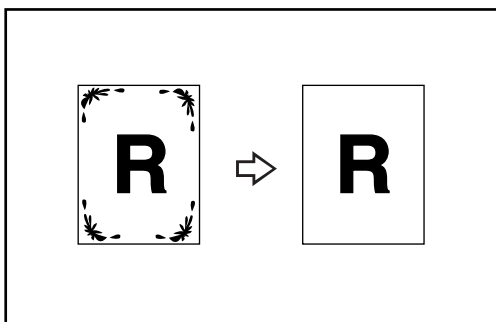

Note

- The length you can input is 0-450mm.

1 Press the [Edit Image] key.

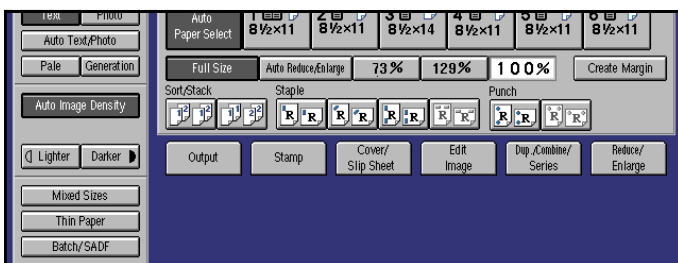

2 Press the [Delete Area] key.

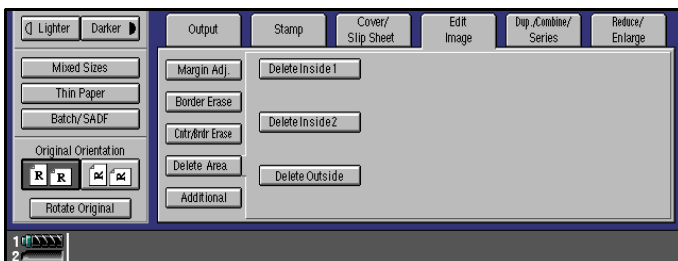

3 Press the [Delete Outside] key.

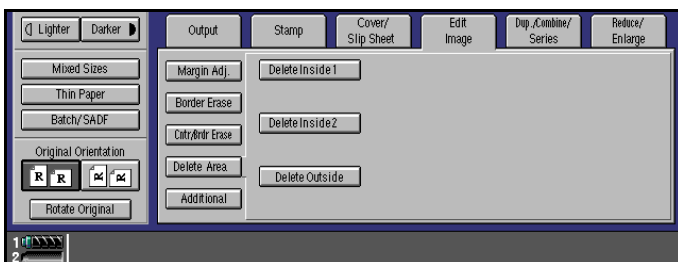

4 Input the value of X1, then press the [#] key or [X2] key.

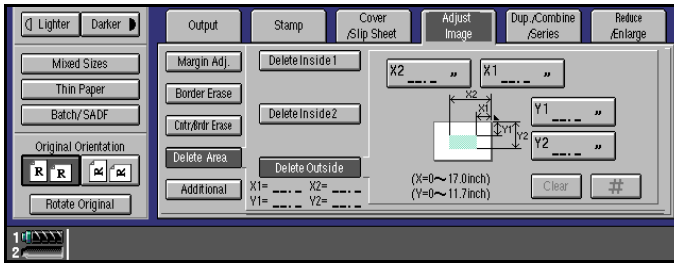

Note

- To change the length entered, press the **[Clear]** key on the control panel or **[Clear]** key on the display panel and enter the new length.

5 Input the value of X2, then press the [#] key or [Y1] key.

6 Input the value of Y1, then press the [#] key or [Y2] key.

7 Input the value of Y2, then press the [#] key.

Note

- To change the number entered, press the item that you want to change and enter the new number.

8 Set your originals then press the **[Start]** key.

Additional

There are additional types of Edit Image mode:

❖ 3 Side Full Bleed

You can make an edge to edge to make with 3 side full bleed.

❖ Double Copies

One original image is copied twice on one copy.

❖ Image Repeat

The original is copied repeatedly.

❖ Centering

You can make copies by moving the image to the center of the copy paper.

3 Side Full Bleed

You can make the full image copy by cutting down the margin of Top, Bottom and Right side.

This function is useful for the originals full of image.

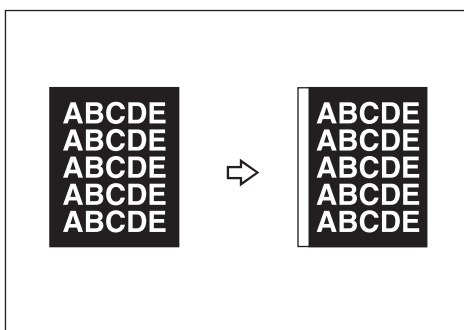

GCBLEE1E

1 Press the [Edit Image] key.

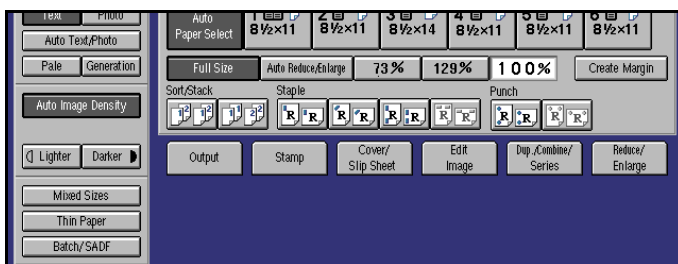

2 Press the [Additional] key.

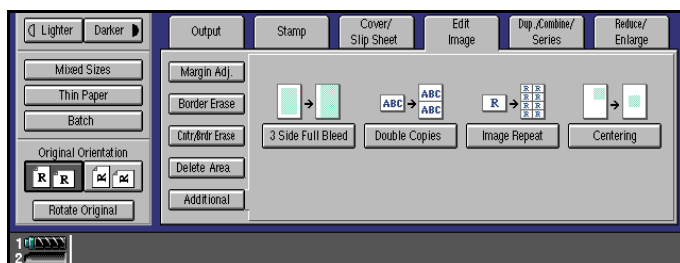

3 Press the [3 Side Full Bleed] key.

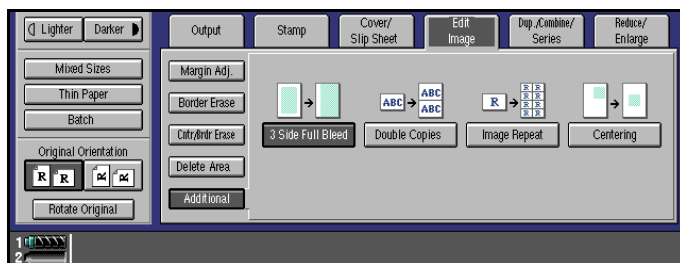

4 Set your originals then press the [Start] key.

Double Copies

The one original image is copied twice on one copy as shown in the illustration.

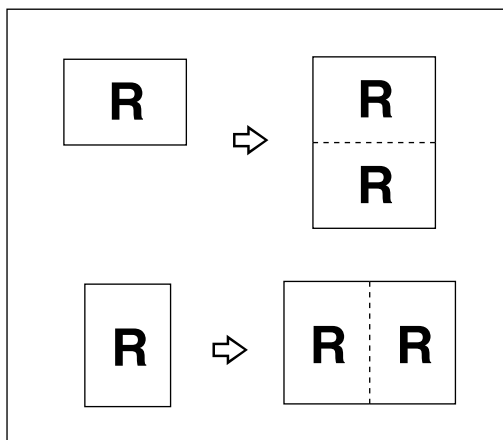

Note

- You can insert lines between repeated images. See “Double Copies Separation Line” ⇒ P.318 “Adjust Image”.
- Refer to the following table when you select original and copy paper sizes with 100 % ratio:

❖ Metric version

Original Size and Direction	Copy Paper Size and Direction
A5	A4
A4	A3
A5	A4

2

❖ Inch version

Original Size and Direction	Copy Paper Size and Direction
5 ¹ / ₂ " × 8 ¹ / ₂ "	8 ¹ / ₂ " × 11"
5 ¹ / ₂ " × 8 ¹ / ₂ "	8 ¹ / ₂ " × 11"
8 ¹ / ₂ " × 11"	11" × 17"

1 Press the [Edit Image] key.

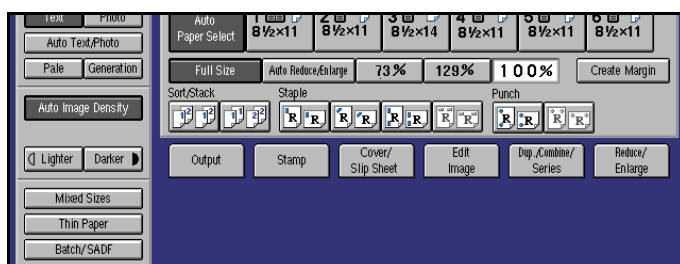

2 Press the [Additional] key.

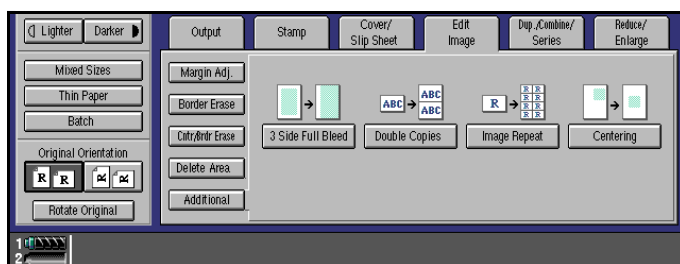

3 Press the [Double Copies] key.

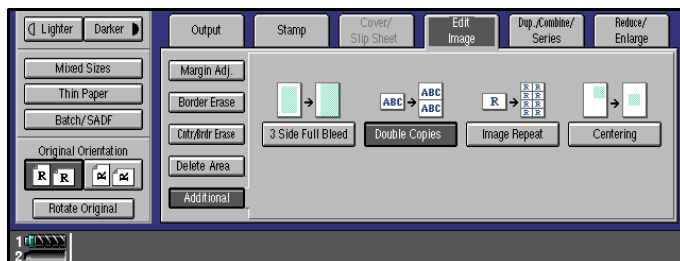

4 Set your originals then press the [Start] key.

Image Repeat

The original image is copied repeatedly.

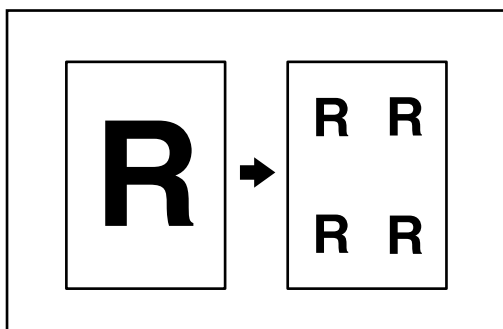

Note

- The number of repeated images depends on the original size, copy paper size, and reproduction ratio. Refer to the following table.

❖ Original: A5  / Copy paper: A4  or Original: A5  / Copy paper A4 

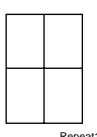
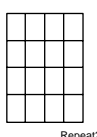
4 repeats (71 %)	16 repeats (35 %)
 <p>Repeat1</p>	 <p>Repeat2</p>

❖ Original: A5  / Copy paper: A4  or Original: A5  / Copy paper A4 

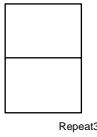
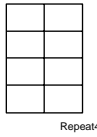
2 repeats (100 %)	8 repeats (50 %)
 <p>Repeat3</p>	 <p>Repeat4</p>

- Part of a repeated image might not be copied depending on copy paper size, copy paper direction or reproduction ratio.
- You can insert separate lines between repeated images. See “Repeat Separation Line” ⇒ P.318 “Adjust Image”.

1 Select the size of the copy paper and the reproduction ratio.

2 Press the [Edit Image] key.

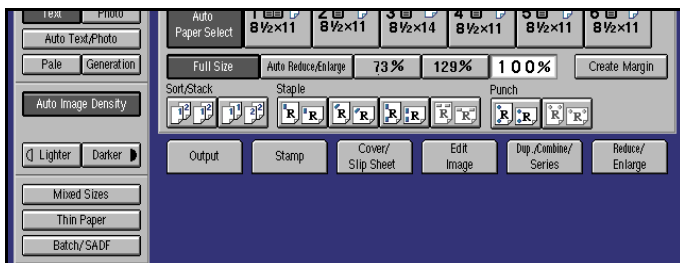

3 Press the [Additional] key.

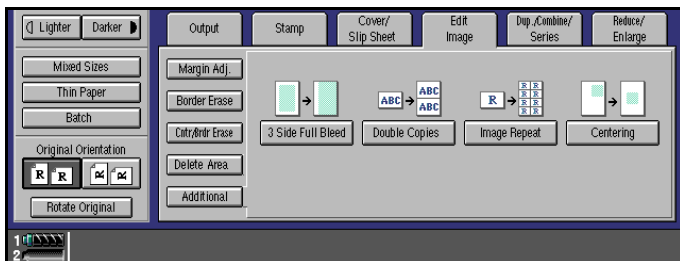

4 Press the [Image Repeat] key.

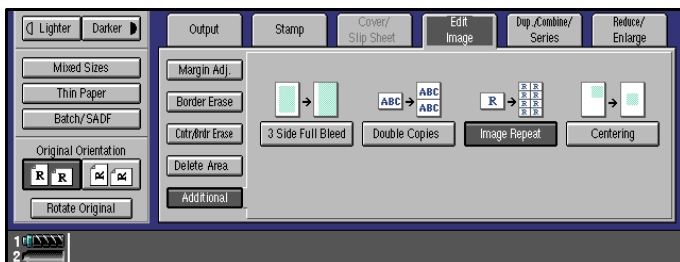

5 Set your original, then press the [Start] key.

Centering

You can make copies by moving the image to the center of the copy paper.

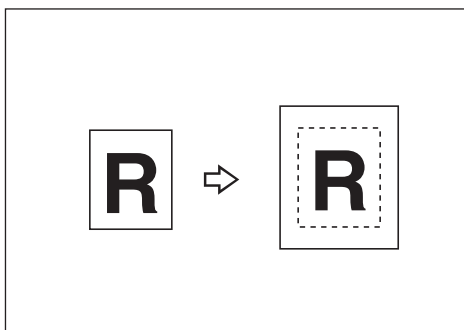

GCCNTROE

⚠ Limitation

- ❑ If the direction of originals is different from that of the copy paper, the machine will not rotate the image by 90°(rotate-copy).
- ❑ This function will not take effect if the size of original cannot be detected.

📝 Note

- ❑ The original sizes and directions for Centering are listed below.

❖ Metric version

Original placed on:	Paper size and direction
Exposure glass	A3☐, B4☐, A4☐☐, B5☐☐, 8 ¹ / ₂ " × 13" ☐ *1
Document feeder	A3☐, B4☐, A4☐☐, B5☐☐, A5☐☐, B6☐☐, 11" × 17"☐, 11" × 15"☐, 8 ¹ / ₂ " × 11" ☐☐, 8 ¹ / ₂ " × 13" ☐ *1

*1 You can select from 8¹/₂" × 13", 8¹/₄" × 13" and 8" × 13" using the user tool (system settings). See "<F/F4> Size Setting" of the "System Settings" manual.

❖ Inch version

Original placed on:	Paper size and direction
Exposure glass	11" × 17"☐, 8 ¹ / ₂ " × 14"☐, 8 ¹ / ₂ " × 11" ☐☐
Document feeder	A4☐☐, 11" × 17"☐, 11" × 15"☐, 8 ¹ / ₂ " × 14"☐, 8 ¹ / ₂ " × 11" ☐☐, 5 ¹ / ₂ " × 8 ¹ / ₂ "☐☐, 8 ¹ / ₂ " × 13" ☐ *1

*1 You can select from 8¹/₂" × 13", 8¹/₄" × 13" and 8" × 13" using the user tool (system settings). See "<F/F4> Size Setting" of the "System Settings" manual.

1 Select the paper.

2 Press the [Edit Image] key.

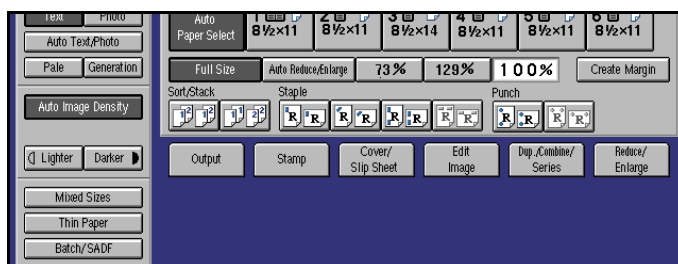

3 Press the [Additional] key.

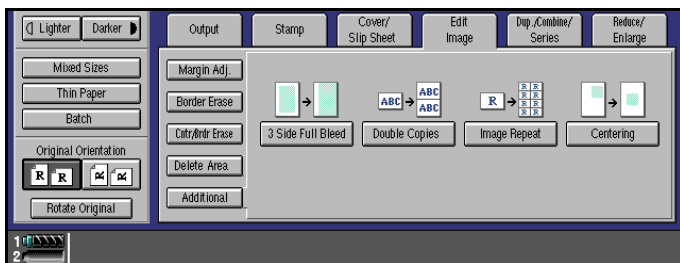

4 Press the [Centering] key.

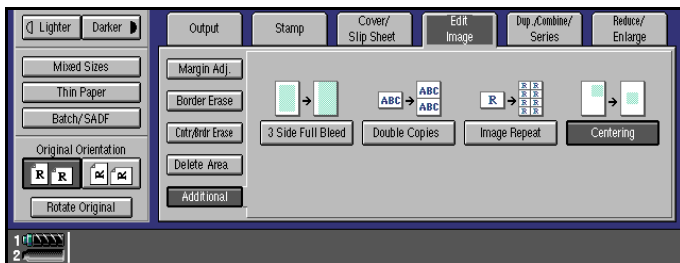

5 Set your originals then press the [Start] key.

Front Cover

The first page of your originals is copied on specified paper sheets for covers.

❖ Copy

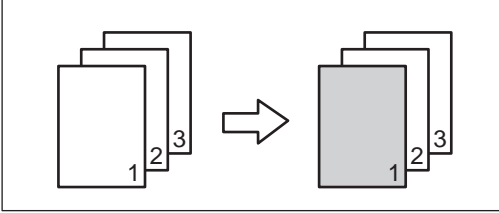

❖ Blank

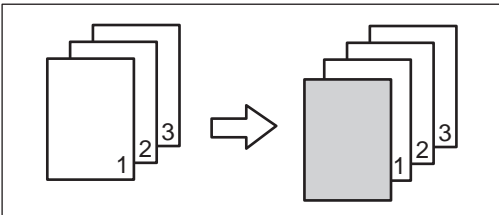

📄 Preparation

Before selecting this function, set the tray for front cover and slip sheet paper. See “Tray Paper Settings” in the System Settings manual.

The cover or slip sheets should be identical in size and direction as the copy paper.

📌 Note

- You can specify whether to copy on the front cover. If you select **[Copy]**, the first page will be copied on the cover sheet. If you select **[Blank]**, a cover sheet will just be inserted before the first copy.
- If Blank mode is selected, the front cover will not be counted as a copy.

1 Press the **[Cover/Slip Sheet]** key.

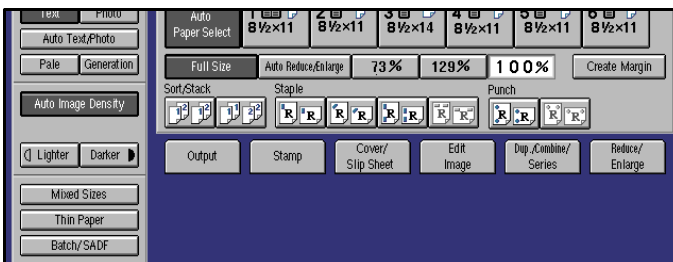

2 Press the [Front Cover] key.

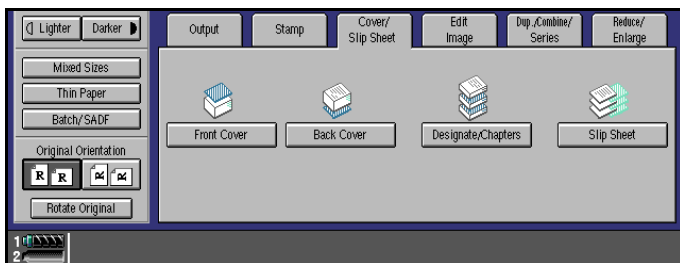

3 Select [Copy] or [Blank] key.

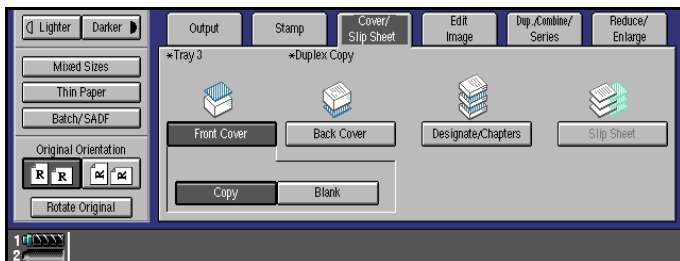

4 Select the paper tray you use.

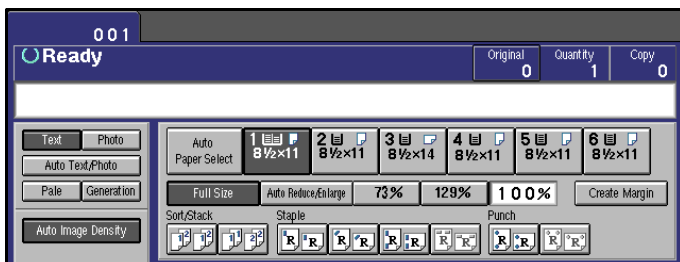

5 Set your originals in the document feeder, then press the [Start] key.

Back Covers

The last pages of your originals are copied on specified paper.

❖ Copy

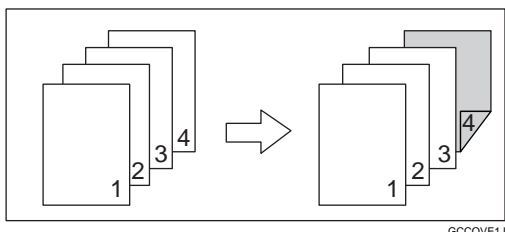

❖ Blank

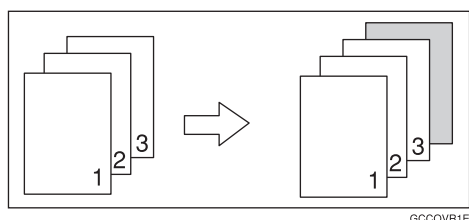

📁 Preparation

Before selecting this function, set the tray for back cover paper and slip sheet paper. See “Tray Paper Settings” in the System Settings manual.

The cover or slipsheets should be identical in size and direction as the copy paper.

📝 Note

- You can specify whether to copy on the back cover. If you select **[Copy]**, the last page will be copied on the cover sheet. If you select **[Blank]**, a cover sheet will just be inserted after the last copy.
- You can specify to print the back cover side on the back or inside of the cover sheet. See “Copy Back Cover” ⇒ P.318 “Adjust Image”.
- If **[Blank]** mode is selected, the back cover will not be counted as a copy.

1 Press the **[Cover/Slip Sheet]** key.

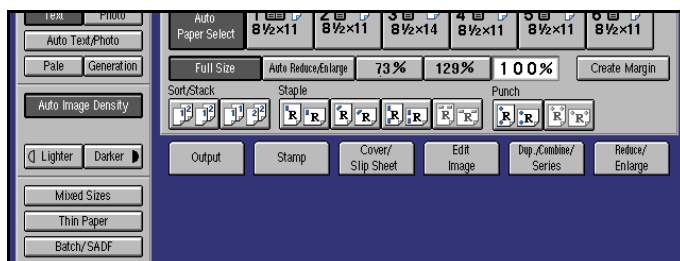

2 Press the [Back Cover] key.

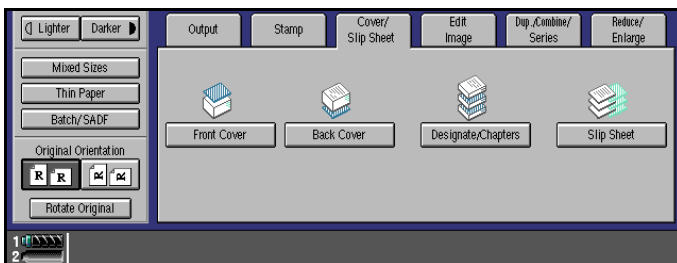

3 Select [Copy] or [Blank] key.

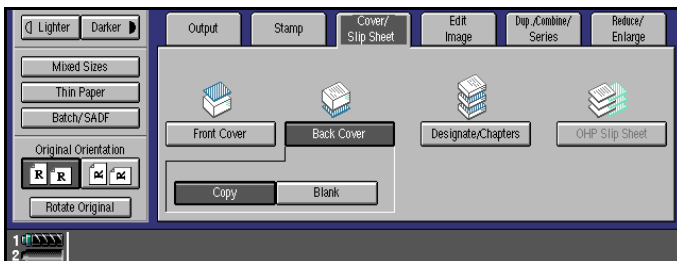

4 Select the paper tray you use.

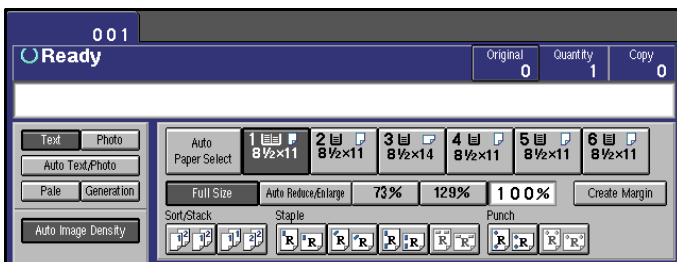

5 Set your originals in the document feeder, then press the [Start] key.

Designate/Chapters

The following functions are explained in this section:

❖ **Designate: Copy**

Use this function to designate certain pages of your original to be copied onto slip sheets.

❖ **Designate: Blank**

Use this function to insert the slipsheet into certain pages of your original.

❖ **Chapters**

When using one-sided to two-sided copying, the page locations you specify with this function will appear on the front of copy sheets beginning a new chapter.

❖ **Slip Sheet Copy**

Use this function to insert the slipsheet into certain pages of your original.

Preparation

Before use this function, specified the paper tray for slipsheet. You can set three trays for slipsheet. See “Tray Paper Settings” in the System Settings manual.

Limitation

- You cannot combine with Slip Sheet function.
- You cannot copy with different size or direction originals.

Note

- You can specify the pages up to 20.
- You can use index tab stock for slipsheet. See “Tray Paper Settings” in the System Settings manual.

Designate: Copy

Use this function to designate certain pages of your original to be copied onto slip sheets.

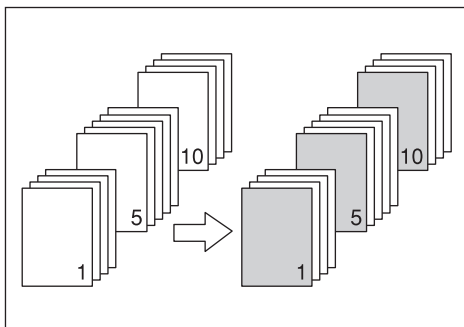

GCCOVR3E

Note

- When “1 Sided → 2 Sided” has been selected, the page numbers you designate will always be copied onto the front of copies in the same way as Chapters mode.

1 Press the [Cover/Slip Sheet] key.

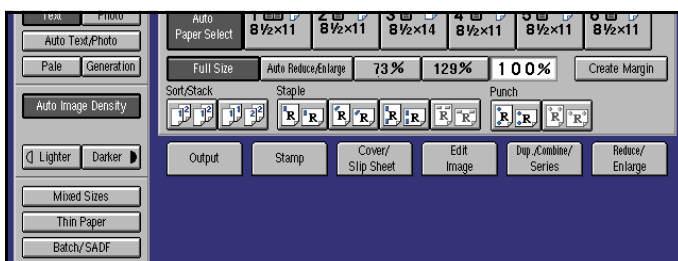

2 Press the [Designate/Chapters] key.

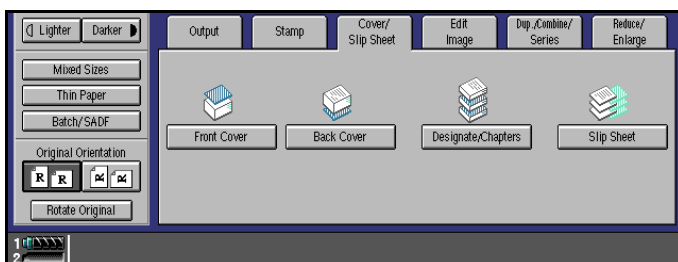

- 3** Press the [Designate: Copy] key.

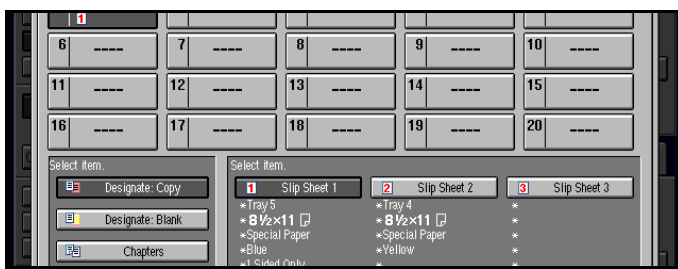

2

- 4** Select the tray you wish to use.



- 5** Select the type of slipsheet.



- 6** Enter the number of the original's location you want to copy onto a slip sheet with the number keys. Then, press the [#] key.

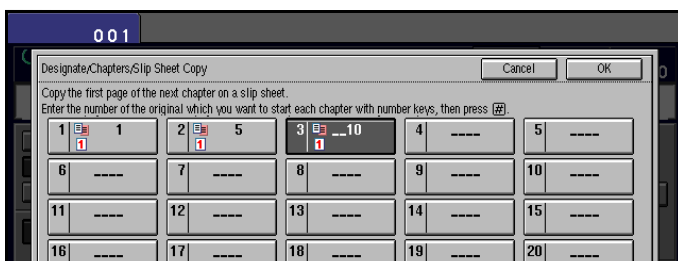

This display shows example settings.

Note

- To change the value entered, press the [Clear] key and enter the new value.

- 7** To specify another page number, repeat step **4** and **5**.

8 When you wish to finish specifying page locations, press the [OK] key.

Note

- To change the number entered, select the desired item, then enter the new number.

9 Set your originals then press the [Start] key.

2

Designate: Blank

Use this function to insert the slipsheet into certain pages of your original.

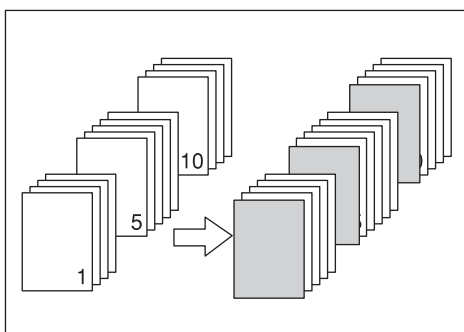

GCCOVR2E

1 Press the [Cover/Slip Sheet] key.

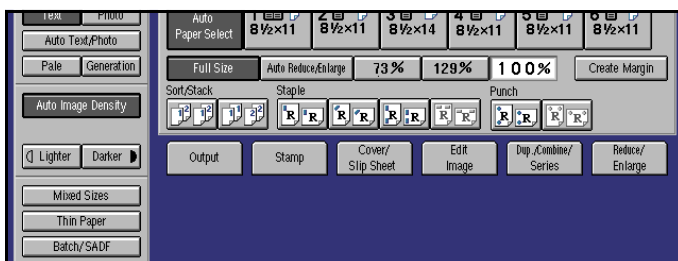

2 Press the [Designate/Chapters] key.

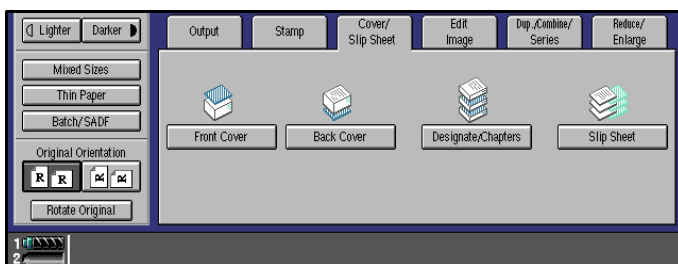

- 3** Press the [Designate: Blank] key.



2

- 4** Select the tray you wish to use.



- 5** Select the type of slipsheet.



- 6** Enter the number of the original's location you want to copy onto a slip sheet with the number keys. Then, press the [#] key.

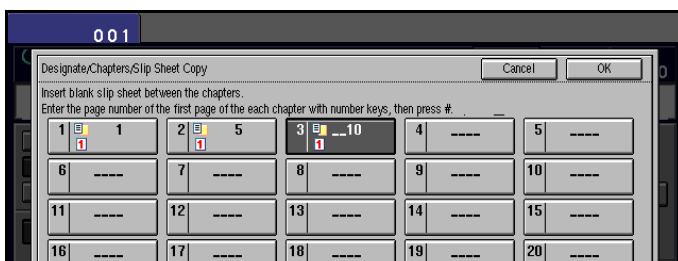

This display shows example settings.

Note

- To change the value entered, press the [Clear] key and enter the new value.

- 7** To specify another page location, repeat step **4** and **5**.

8 When you wish to finish specifying page location, press the **[OK]** key.

Note

- To change the number entered, select the desired item, then enter the new number.

9 Set your originals then press the **[Start]** key.

2

Chapters

When using one-sided to two-sided copying, the page locations you specify with this function will appear on the front of copy sheets beginning a new chapter.

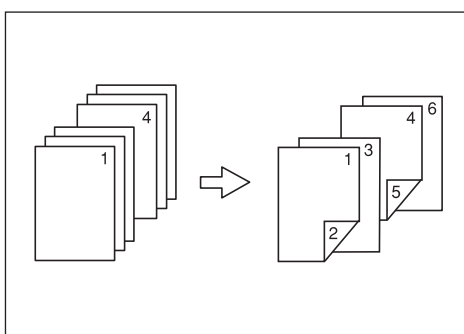

GCSHOW0E

Preparation

Before selecting this function, press the **[Dup./Combine/Series]** key and select “1 Sided” for original, and “2 Sided” for copy.

Limitation

- You cannot use this function with Slip Sheet mode.

Note

- You can specify up to 20 chapter locations.
- This function can be combined with the Designate function.

1 Press the **[Cover/Slip Sheet]** key.

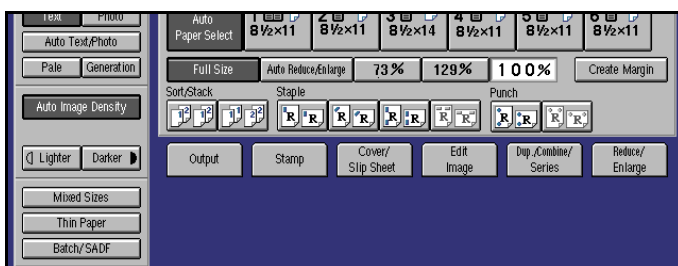

2 Press the [Designate/Chapters] key.

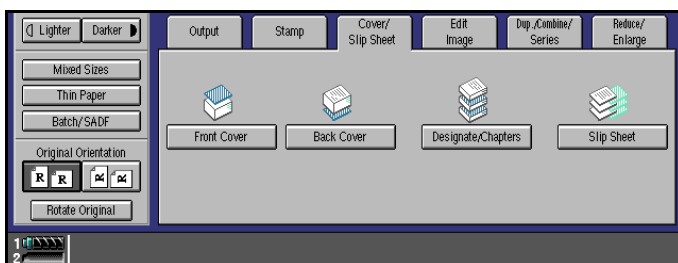

2

3 Press the [Chapters] key.



4 Enter the page location of the first page of the first chapter with the number keys. Then, press the [#] key.

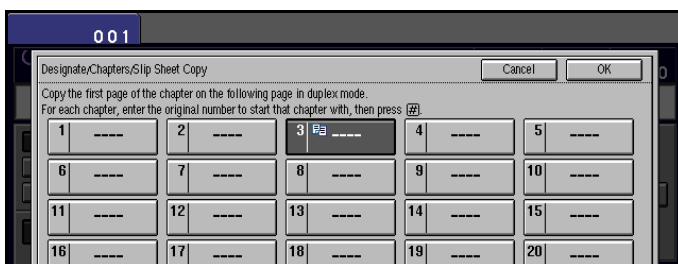

This display shows example settings.

Note

To change the value entered, press the [Clear] key and enter the new value.

5 To specify another page location, repeat step 4.

6 When you finish specifying the page location, press the [OK] key.

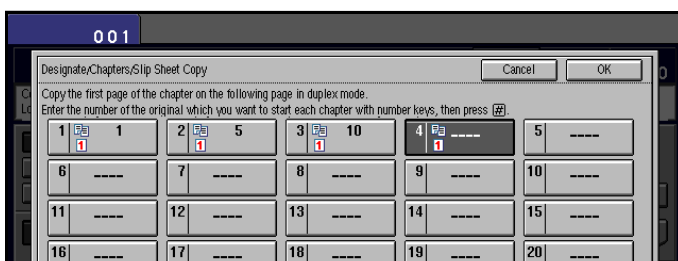

Note

- To change the number entered, select the desired item, then enter the new number.

7 Select the paper tray.

8 Set your originals then press the **[Start]** key.

2

Slip Sheet Copy

Use this function to insert the slipsheet into certain pages of your original.

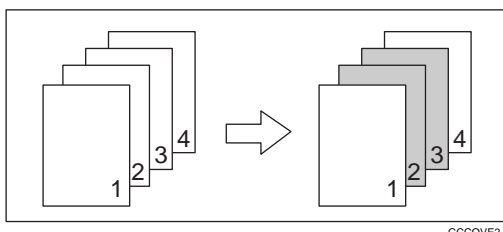

GCCOVE2J

1 Press the **[Cover/Slip Sheet]** key.

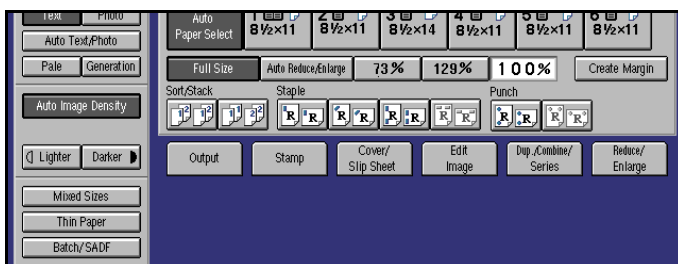

2 Press the **[Designate/Chapters]** key.

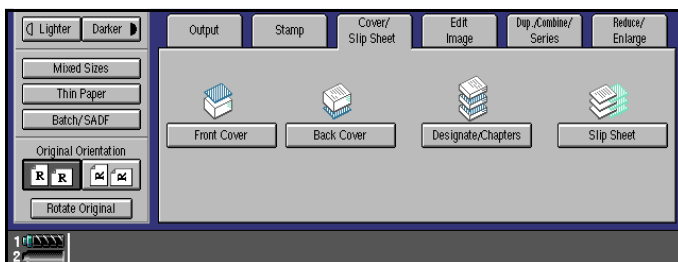

3 Press the [Slip Sheet Copy] key.

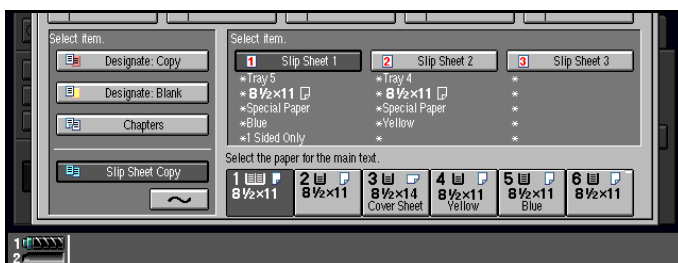

2

4 Select the tray you wish to use.



5 Select the type of slipsheet.

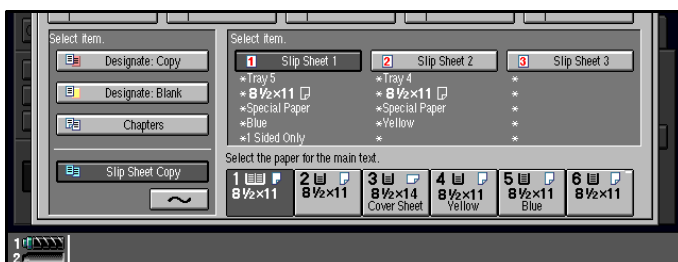

6 Enter the number of the original's location you want to copy onto a slip sheet with the number keys. Then, press the [#] key.

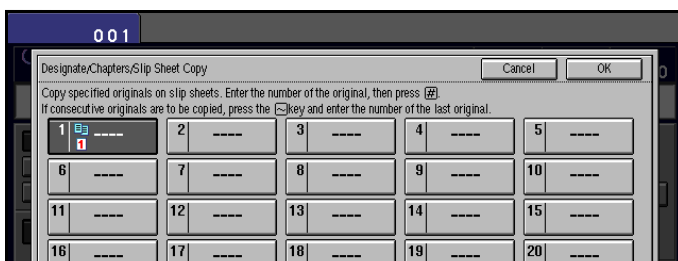

This display shows example settings.

Note

- To change the value entered, press the [Clear] key and enter the new value.

7 Press the [~] key.

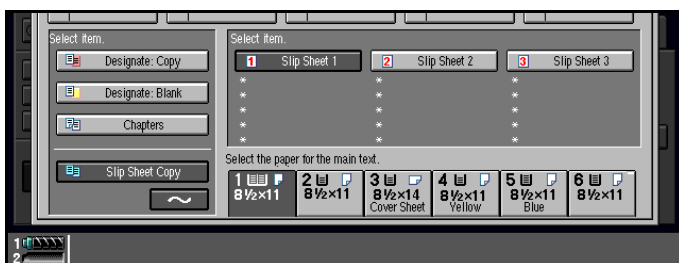

2

8 Enter the last number of the original. Then press the [#] key.

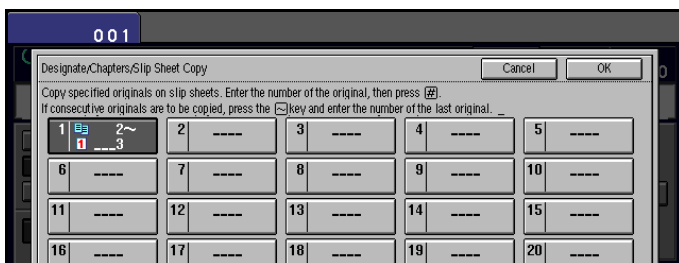

9 To specify another page location, repeat step 4 and 7.

10 When you wish to finish specifying page location, press the [OK] key.

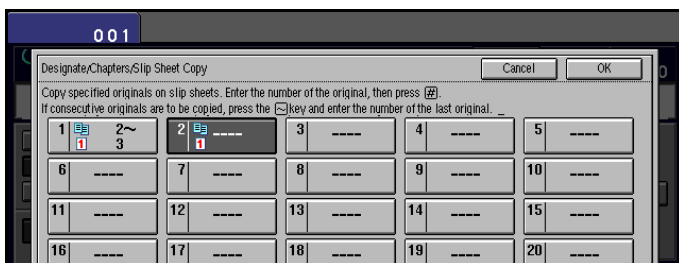

Note

To change the number entered, select the desired item, then enter the new number.

11 Set your originals then press the [Start] key.

Slip Sheets

This function inserts a sheet of paper from a different paper tray between each page copied. This function can be used to insert a slip sheet automatically between OHP transparencies or used as a way of separating pages. You can also copy onto the inserted slip sheets.

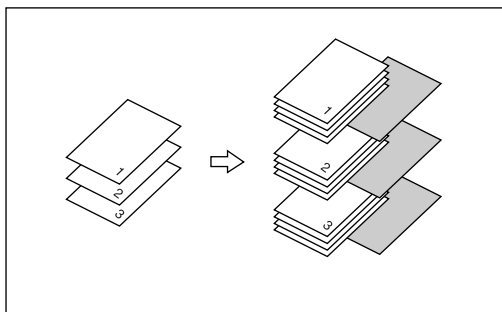

2

Preparation

Before selecting this function, specify the paper tray for slip sheets. The paper tray for the slipsheets is selected “Slip sheet: Tray 1” automatically. See “Tray Paper Settings” in the System Settings manual.

Limitation

- You cannot use this function with Chapters and Designate modes.

Note

- Set the slip sheets in the same orientation as originals.
- You can specify whether to make copies onto the inserted slip sheets or not.
- If you do not copy onto slip sheets, they are excluded from the number of copies counted.

To Insert Slip/Copy Onto Sheets

❖ Copy

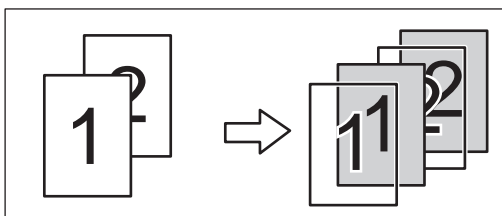

❖ **Blank**

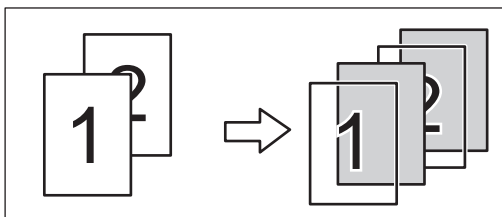

2

Note

- ❑ When you want to set the OHP sheet in paper tray, see “Tray Paper Settings” in the System Settings manual.

1 Press the **[Cover/Slip Sheet]** key.

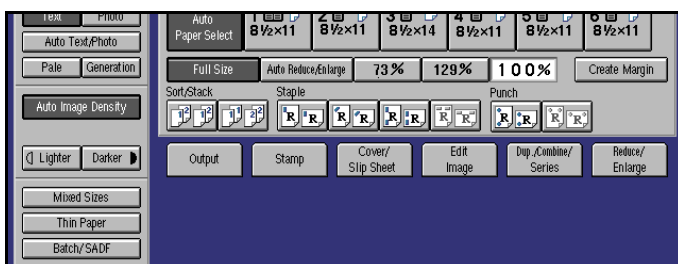

2 Press the **[Slip Sheet]** key.

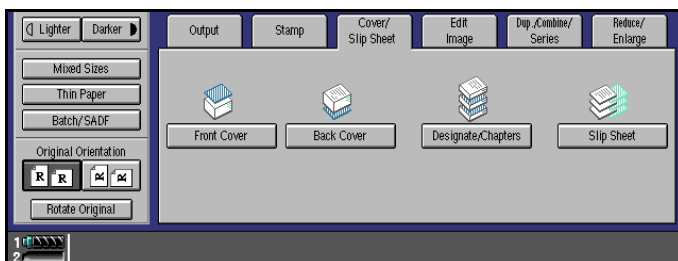

3 Select **[Copy]** or **[Blank]** key.

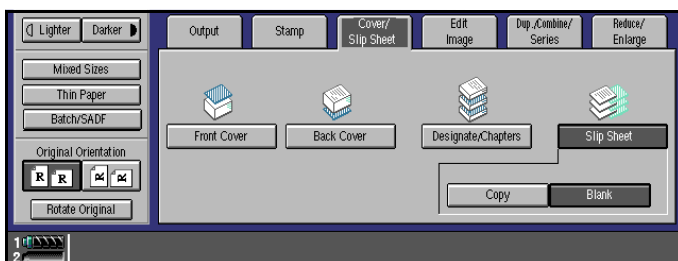

4 Select the paper tray containing the non-slip sheet paper.

5 Set your originals then press the **[Start]** key.

Background Numbering

Use this function to have numbers printed on the background of copies. This function can help you to keep track of confidential documents.

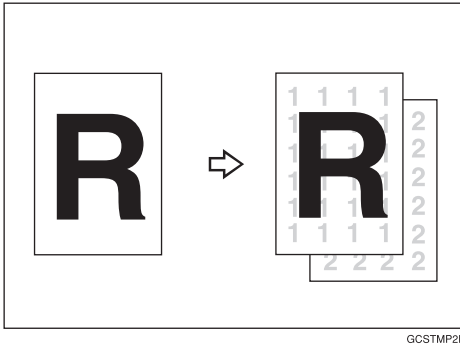

Note

- You can change some settings (e.g., density) of the numbers with the User Tools. See ⇒ P.323 “Background Numbering”.
- Numbers are printed on all pages.
- If you combine this function with other stamp functions, numbers might overlap other stamps.
- You cannot combine Background Numbering function with staple or Punch function.
- You can select whether the Background Numbering is printed negative if it overlaps black parts of image ⇒ P.323 “Preset Stamp”.
- You can change the starting number of the Background Numbering (1-9999).

1 Press the [Stamp] key.

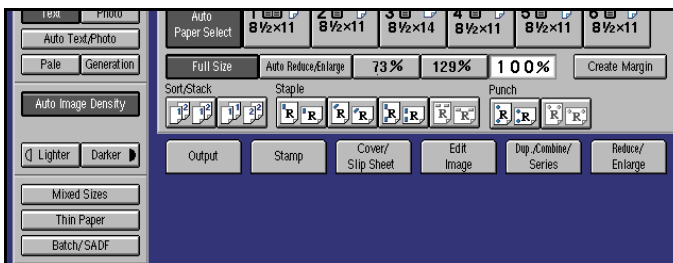

2 Press the [Background No.] key.



3 To change the entered number, press the [Change] key. If you do not wish to, go to step **5**.

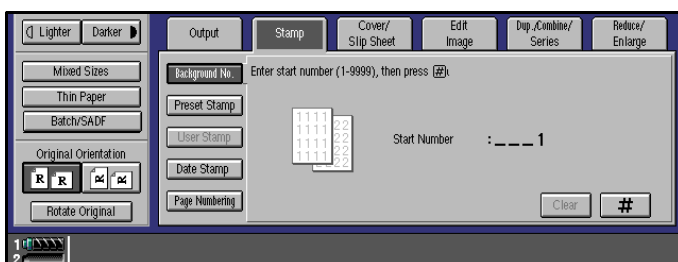

4 Enter the number to start counting from with the number keys. Then press the [#] key.

Note

- To change the entered number, press the [Clear] key on the control panel or press the [Clear] key on the display panel then enter the new number.



5 Set your originals and press the [Start] key.

Preset Stamp

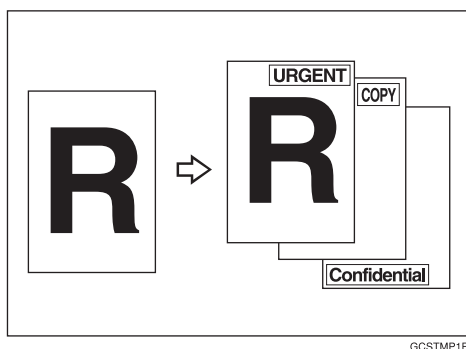

! Limitation

- One message can be stamped at a time. However, you can combine with only one user stamp.
- When you combine this feature with the Magazine or Booklet function, only the first page is stamped.

📝 Note

- One of the following eight messages can be stamped on copies with a frame around it: "COPY", "URGENT", "PRIORITY", "For Your Info.", "PRELIMINARY", "For Internal Use Only", "CONFIDENTIAL", "DRAFT".
- You can change some Preset Stamp settings (e.g., density) with the User Tools. See ⇒ P.323 "Preset Stamp", ⇒ P.170 "To change the stamp position, size or density".
- The default stamp position is "Top Right". You can change this with the User Tools. See ⇒ P.323 "Preset Stamp", ⇒ P.170 "To change the stamp position, size or density".
- You can change the stamp language with the User Tools. See ⇒ P.323 "Preset Stamp".
- You can select whether the Preset Stamp is printed negative if it overlaps black parts of the image. See ⇒ P.323 "Preset Stamp".
- You cannot combine Preset Stamp function with Staple or Punch function.

- The relationship between the direction in which you set the original and stamp orientation/position is as follows:

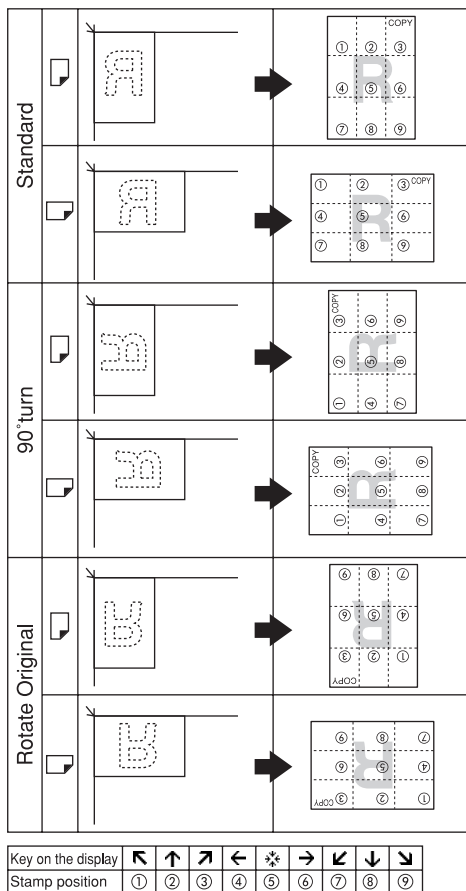

1 Press the [Stamp] key.

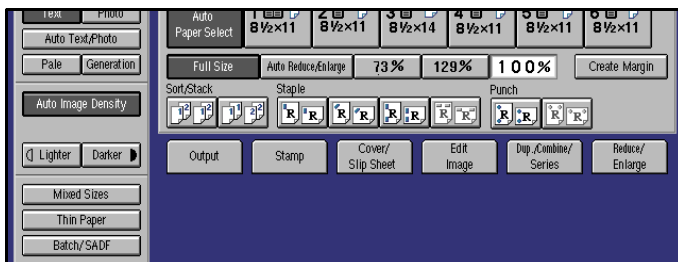

2 Press the [Preset Stamp] key.



2

3 Select the desired message by touching the appropriate key.



4 Select the print page.

Note

- If you combine this feature with the magazine or Booklet function, "1st Page Only" is selected automatically.

To have only the first page stamped

1 Press the [1st Page Only] key.



To change the stamp position, size or density

1 Press the [Change] key.

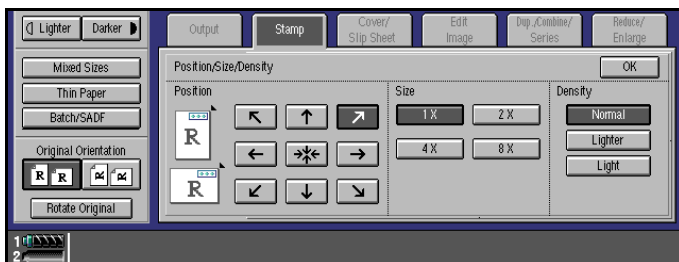

2

2 Select the desired position, size and density by touching the appropriate keys.

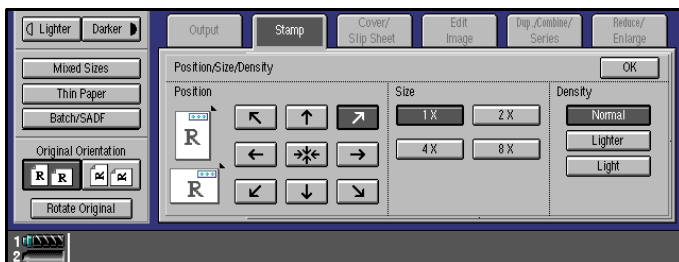

3 Press the [OK] key.

5 Set your originals then press the [Start] key.

User Stamp

Up to five messages which you use frequently can be stored in the machine's memory and stamped on copies.

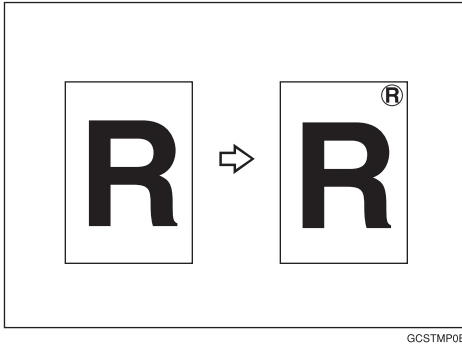

Preparation

Before using this function, you have to store your messages with the User Tools. See ⇒ P.325 “User Stamp”.

Note

- The default stamp position is “Top Right”. You can change this with the User Tools. See ⇒ P.325 “User Stamp”, ⇒ P.173 “To change the stamp position”.
- If the position exceeds the page boundary, the stamp will not be printed on copies.
- You can combine this feature with only one Preset Stamp.

- The relationship between the direction in which you set the original and stamp Orientation/Position is as follows:

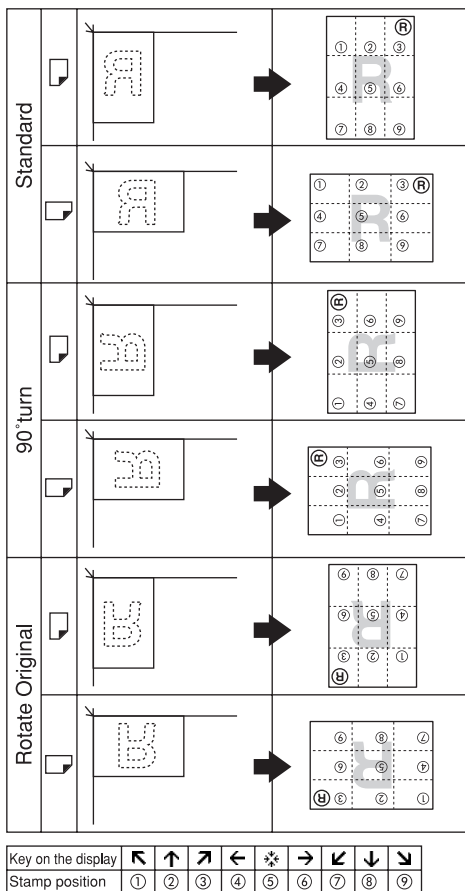

- You cannot combine User Stamp function with Staple or Punch function.

1 Press the [Stamp] key.

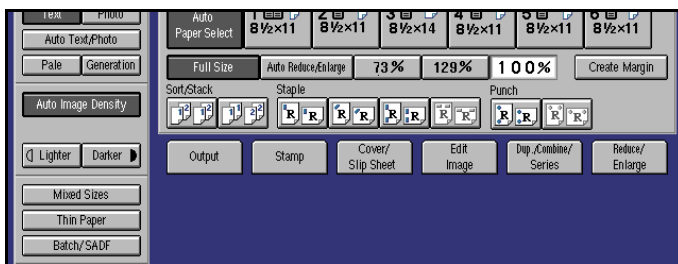

2 Press the [User Stamp] key.

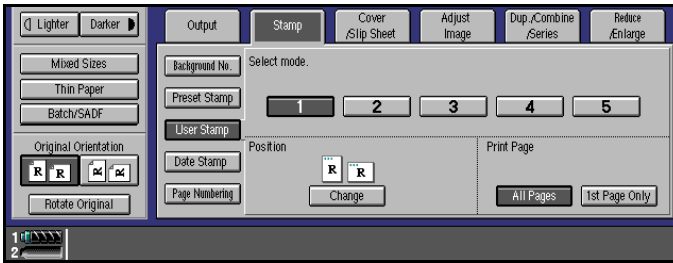

2

3 Touch a number to select the stamp you require.

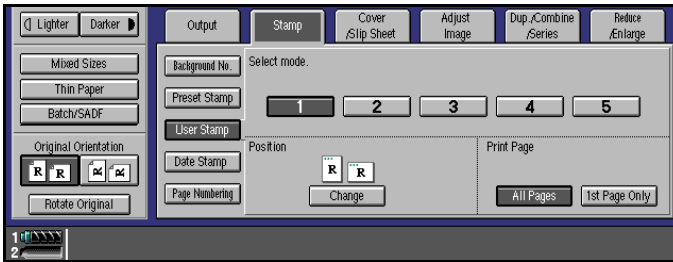

4 Select the stamp position and numbering format.

To have on the first page stamped

1 Press the [1st Page Only] key.

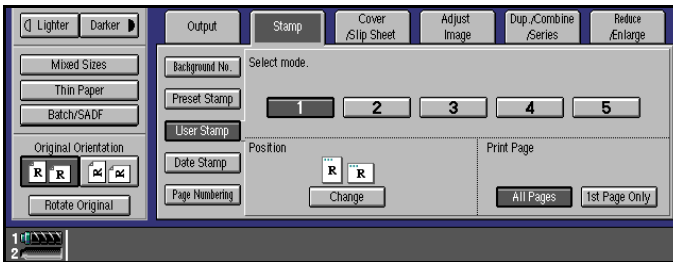

To change the stamp position

1 Press the [Change] key.

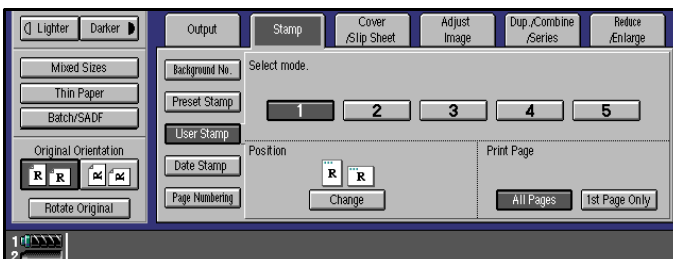

- 2 Select the desired position by touching keys.

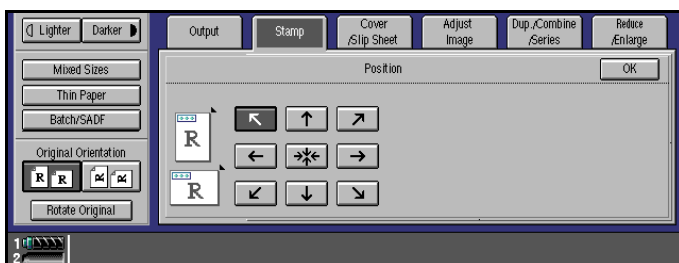

- 3 Press the [OK] key.

- 5 Set your originals then press the [Start] key.

Program/Delete User Stamp

- 1 Make sure that the machine is in Copy mode.

- 2 Press the [User Tools] key.

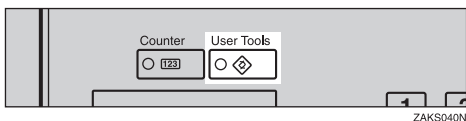

- 3 Press the [Copier/Document Server Features] key.

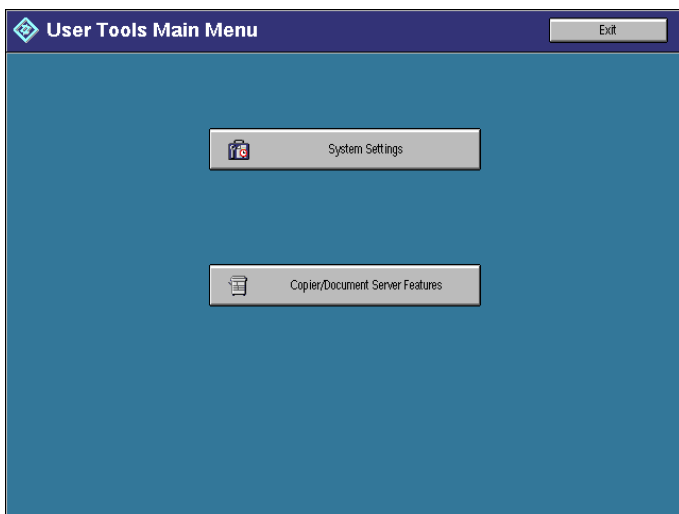

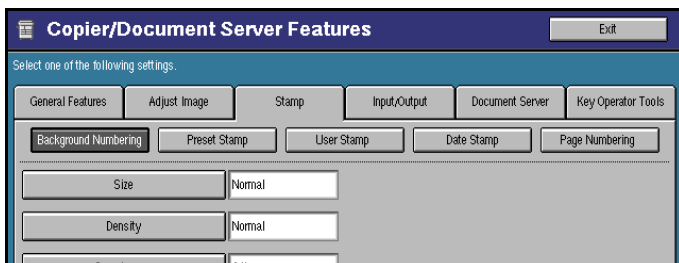
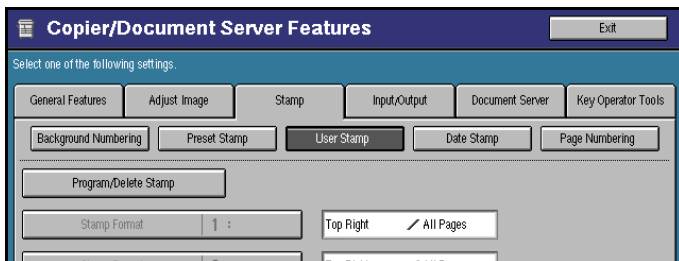
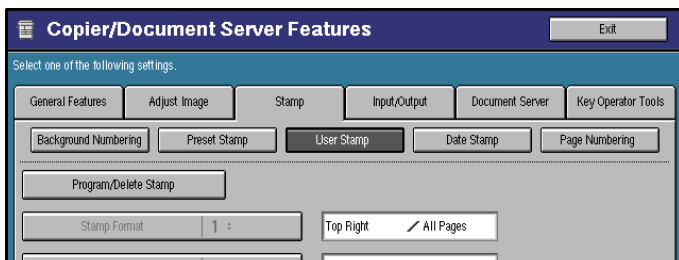
4 Press the [Stamp] key.**5** Press the [User Stamp] key.**6** Press the [Program/Delete Stamp] key.

To program the User Stamp

1 Press the [Program] key.

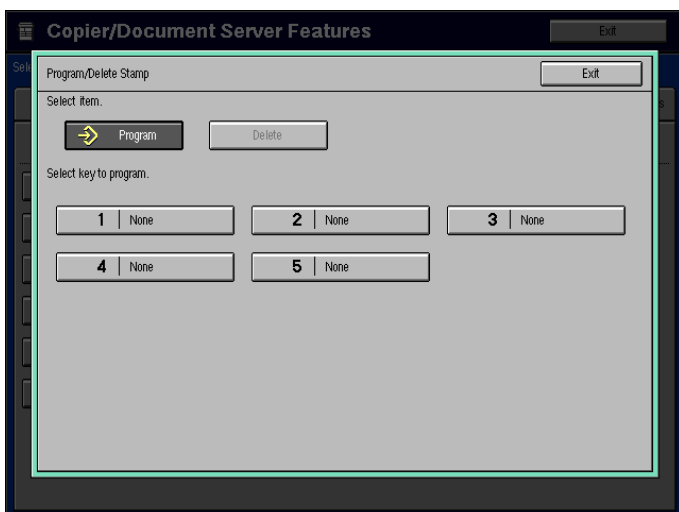

2 Press the stamp number (1-5) you want to program.

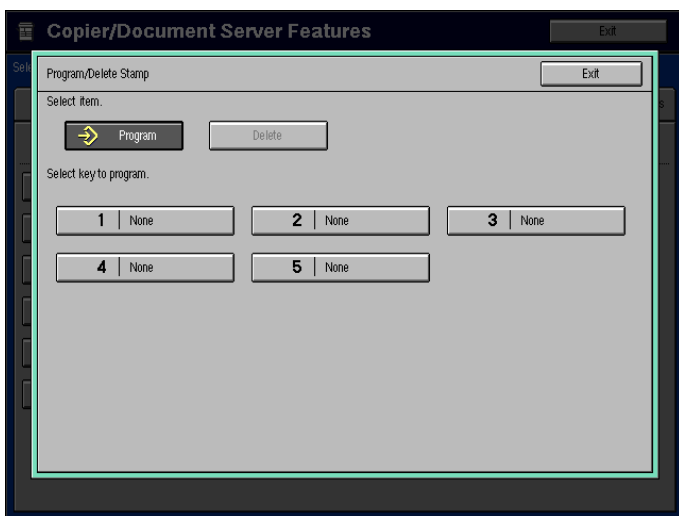

Note

- Stamp numbers with  already have settings in them.
- If the stamp number is already being used, the machine will ask you if you wish to overwrite it - Press the **[Yes]** or **[No]** key.

- 3 Enter the user stamp name with the letter keys on the display panel. Then press the [#] key.

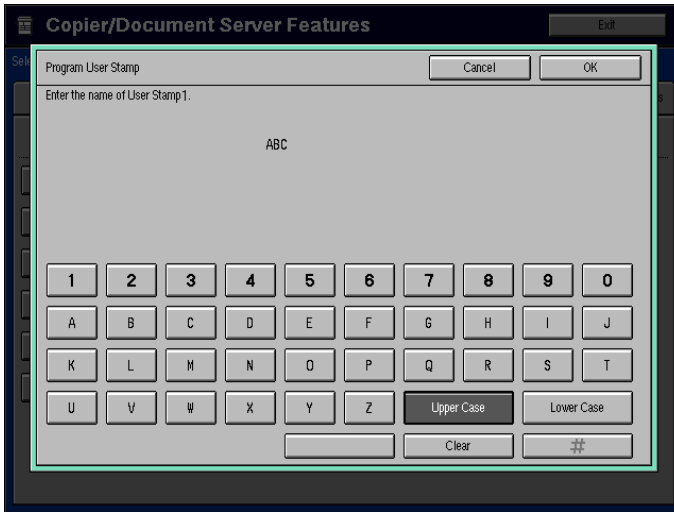

Note

- You can register up to 8 characters.
- To change the name entered, press the **[Clear]** key and enter new letter.

- 4 Press the **[OK]** key.

- 5 Enter the vertical and horizontal size of the stamp with the number keys. Then press the [#] key.

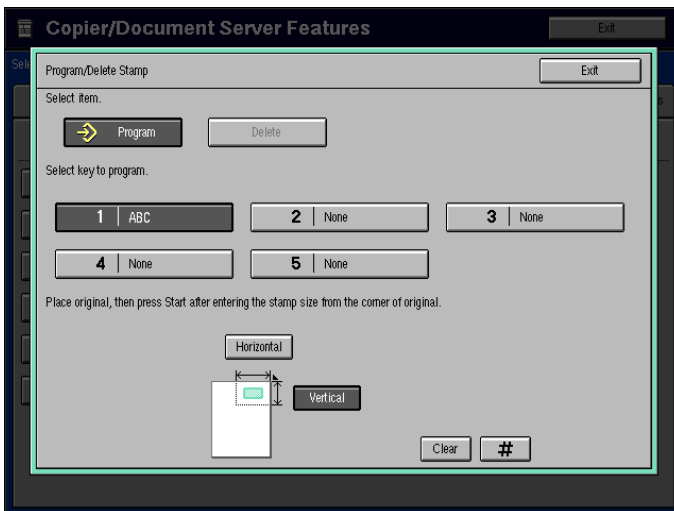

Note

- To change the value entered, press the **[Clear]** key on the control panel or **[Clear]** key on the display and enter the new value.
- You can enter sizes within 100 × 200mm, 3.9" × 7.8".

- 6 Set the user stamp on the exposure glass, and then press the [Scan Start] key.
- 7 Press the [Exit] key.

To delete the User Stamp

Important

- You cannot restore deleted stamp.

- 1 Press the [Delete] key.

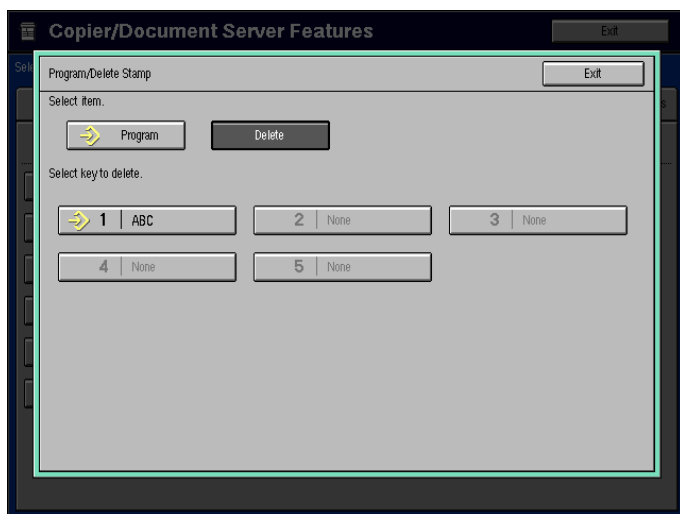

- 2 Press the stamp number (1-5) you want to delete.

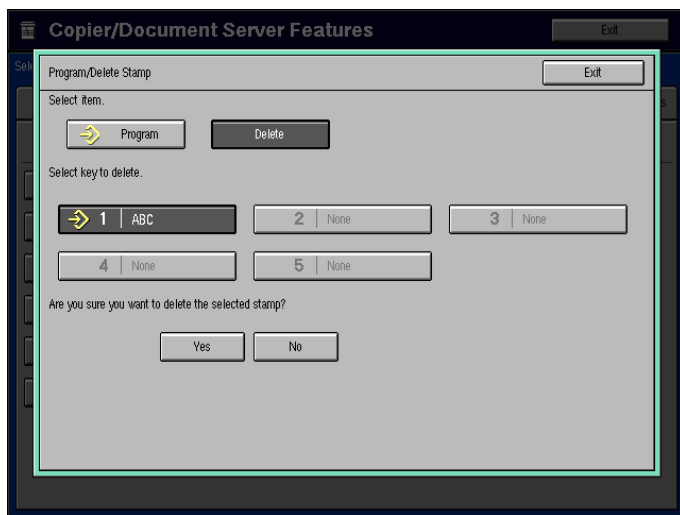

Note

- Only programs with  contain a user stamp.

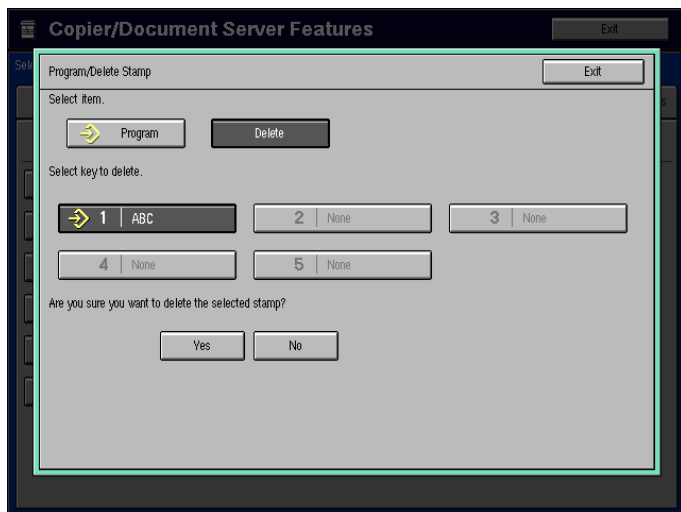
3 Press the [Yes] key.**Note**

- To cancel the deletion, press the [No] key.

4 Press the [Exit] key.**7** Press the [User Tools] key.

The initial display appears.

Date Stamp

2

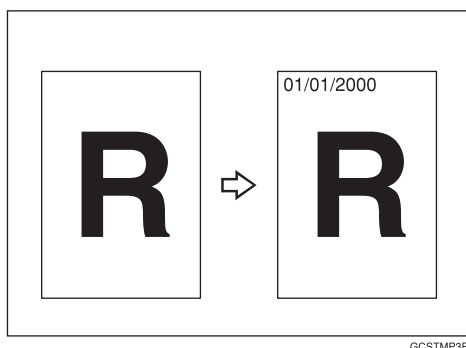

! Limitation

- If you combine this feature with the magazine or Booklet feature, you can not set the Page Numbering at a same time.

📝 Note

- You can select the following styles:
 - MM/DD/YYYY
 - MM.DD.YYYY
 - DD/MM/YYYY
 - DD.MM.YYYY
- You can change the Date Stamp settings with the User Tools. See ⇒ P.325 "Date Stamp".
- The size and fonts of the Date Stamp can be changed with the User Tools. See ⇒ P.180 "Date Stamp".
- The default direction is "Top Left". You can change this setting with the User Tools.
- The size, font and superimpose settings are linked with Page Numbering features.
- You cannot combine Date Stamp function with Staple or Punch function.

- The relationship between the direction in which you set the original and the stamp position is as follows:

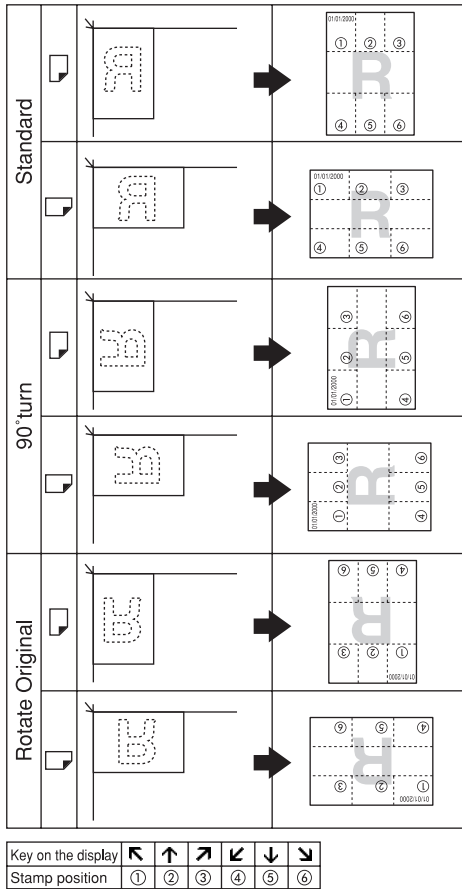

GCSTAM7E

- If you combine with Duplex mode, the page is stamped on the back side as follows.

- Combine with 1 Sided/2 Sided in Combine mode

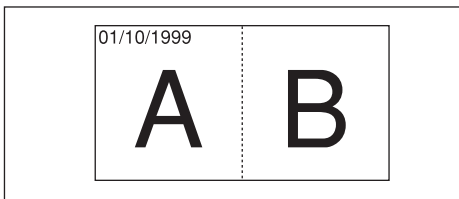

GCSTMP5E

- Combine with Booklet or Magazine mode

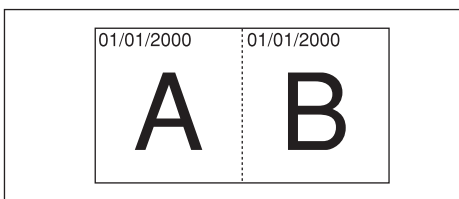

GCSTMP4E

1 Press the [Stamp] key.

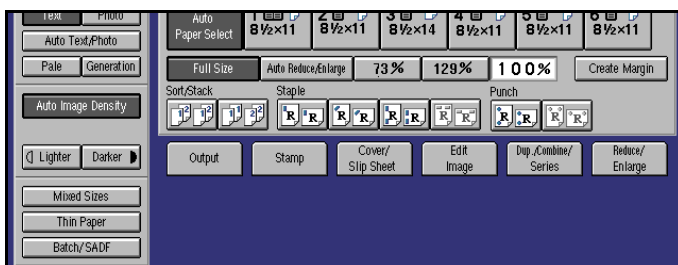

2 Press the [Date Stamp] key.



To change the stamp position

1 Press the [Change] key.

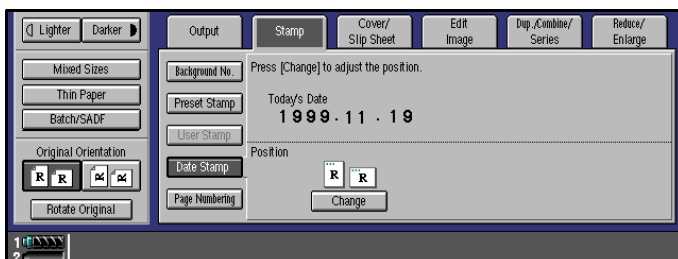

2 Select the desired position of the Date Stamp with the keys on the display.



3 Press the [OK] key.

3 Set your originals then press the [Start] key.

Page Numbering

Use this feature to print page numbers on your copies. There are six types of page numbering (n is the total number of pages in your original):

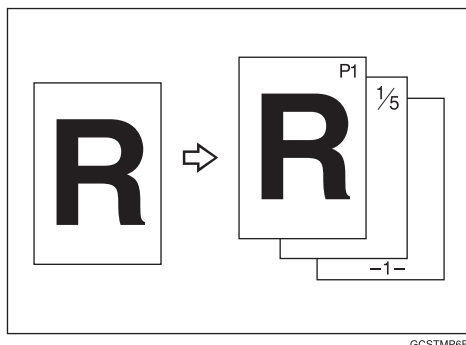

- Type A: P1,P2,...Pn
- Type B: 1/n,2/n,...n/n
- Type C: -1-,-2-,...-n-
- Type D: 1, 2...n
- Type E: P.1,P.2,...P.n
- Type F: 1-1,1-2,..1-n

⚠ Limitation

- When you set book or magazine function, you can not set date stamp function at the same time.

📝 Note

- You can change the page numbering settings with the User Tools. See ⇒ P.326 "Page Numbering".
- The size and font of Page Numbering can be changed with the User Tools. See ⇒ P.326 "Page Numbering".
- The size, fonts and superimpose settings are linked with Date Stamp features.
- You cannot combine Page Numbering function with Staple or Punch function.

- The relationship between the direction in which you set the original and the page numbering orientation/position is as follows:

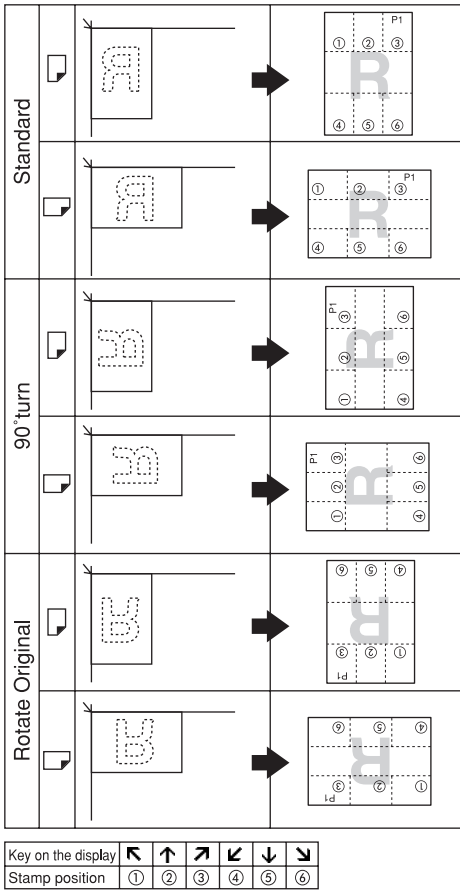

- If you combine with Duplex (Top to Top) mode, the page is stamped on the back side as follows.

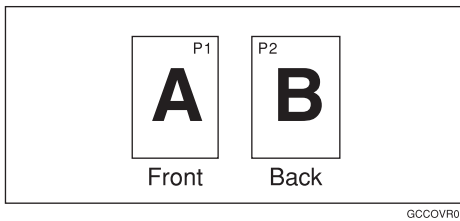

- If you combine with Duplex mode, you can stamp the same position with front side. You can change this settings with the User Tools. ⇒ P.326 "Page Numbering"
- If you use this function with Combine mode, the page is stamped as follows.

- Combine with 1 Sided/2 Sided in Combine mode.

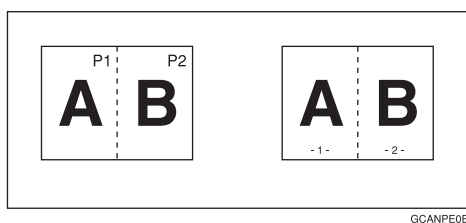

GCANPE0E

- Combine with Booklet or Magazine mode.

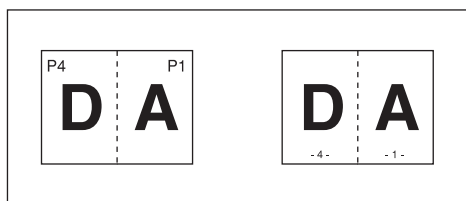

GCANPE1E

1 Press the [Stamp] key.

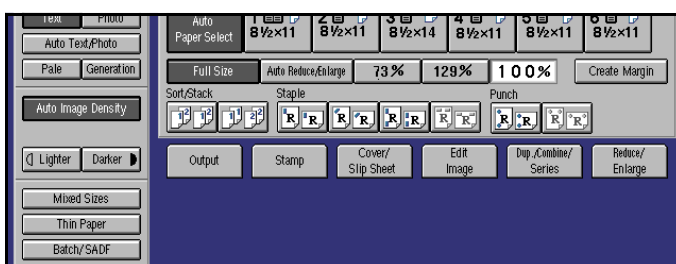

2 Press the [Page Numbering] key.

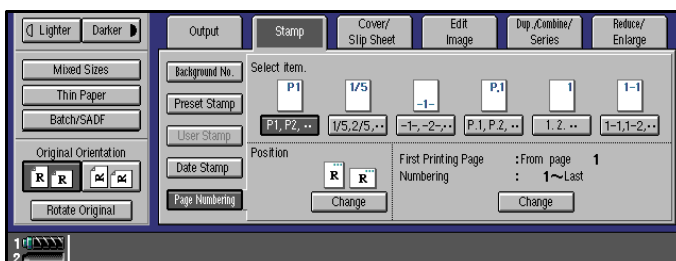

3 Select the desired format and orientation by touching the appropriate keys on display.

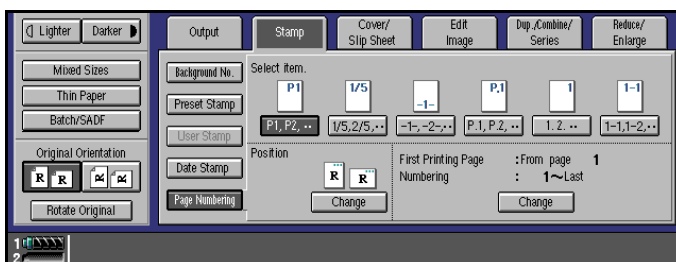

If you selected (P1,P2..., -1-, -2-..., P.1, P.2..., 1, 2...,) in step 1.

1 Press the [Change] key.

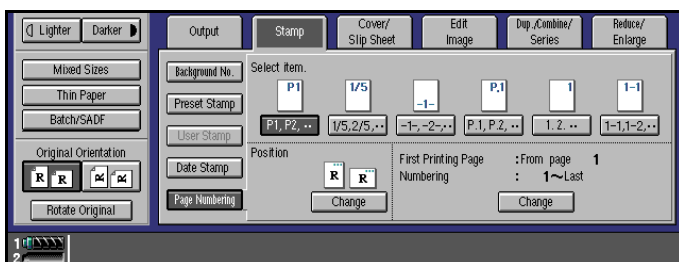

2 Press the [First Printing Page] key, then enter the original sheet number on which you wish numbering to begin.

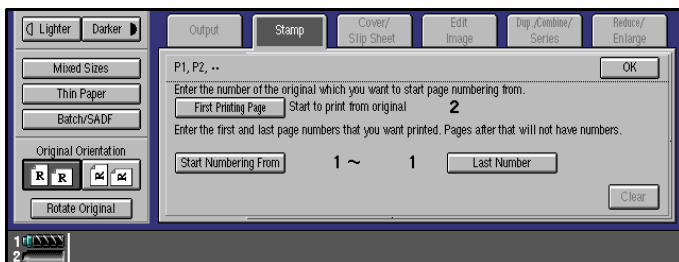

Note

- To change the number entered, press the [Clear] key on the control panel or press the [Clear] key on the display panel and then enter a new number.

3 Press the [Start Numbering From] key, then enter the number at which you wish numbering to start with the number keys.

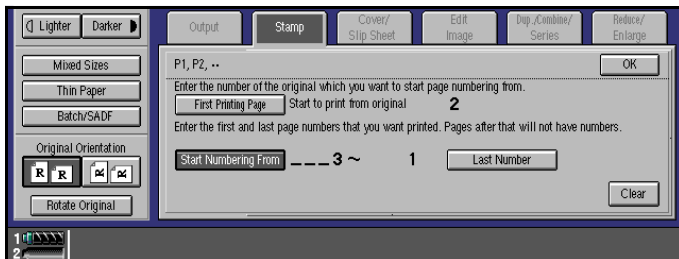

- 4 Press the **[Last Number]** key, then enter the page number at which you wish numbering to stop with the number keys.

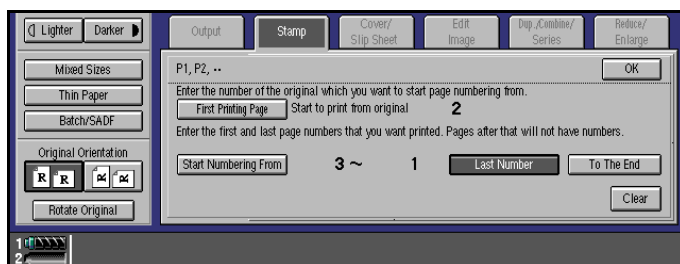

Note

- If you wish to print onto the last page, press **[To The End]** key.

If you selected (1/5,2/5...) in step 3

- 1 Press the **[First Printing Page]** key, then enter the original sheet number on which you wish numbering to begin.

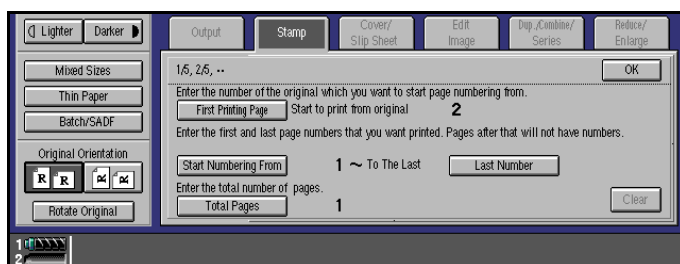

Note

- To change the number entered, press the **[Clear]** key on the control panel or press the **[Clear]** key on the display and then enter a new number.
- 2 Press the **[Start Numbering From]** key, then enter the page number to start numbering using the number keys.

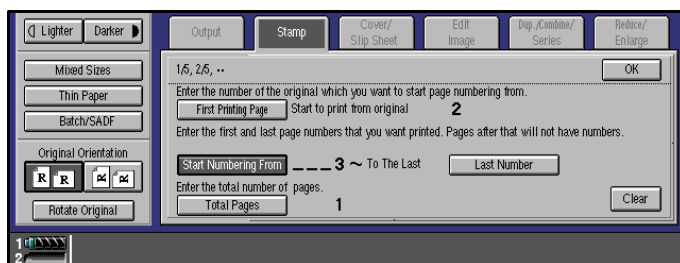

- Press the **[Last Number]** key, then enter the page number to stop numbering using the number keys.

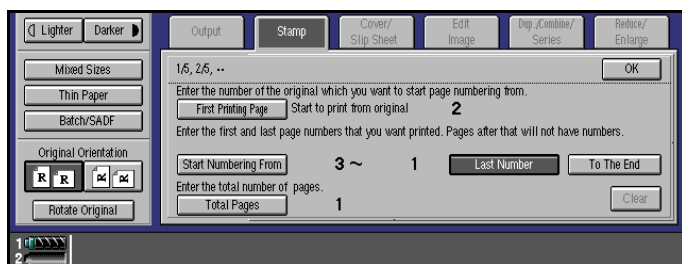

Note

- If you wish to print onto the last page, press **[To The End]** key.

- Press the **[Total Pages]** key, then enter the total number of original pages using the number keys.

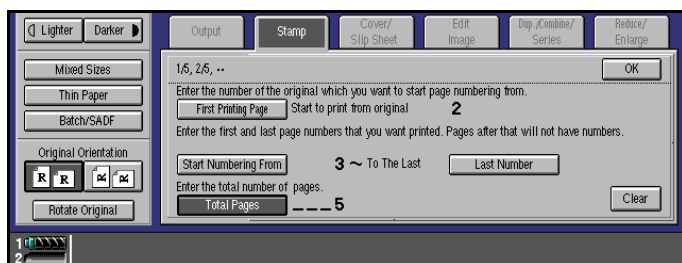

If you selected (1-1, 1-2,...) in step 3

- Press the **[First Printing Page]** key, then enter the original sheet number on which you wish numbering to begin.

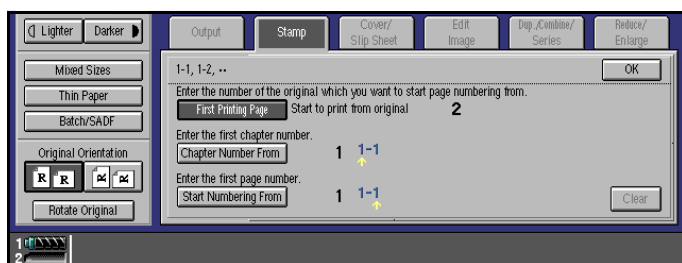

Note

- To change the number entered, press the **[Clear]** key on the control panel or press the **[Clear]** key on the display panel and then enter a new number.

- 2 Press the [Chapter Number From] key, then enter the chapter number starting the numbering using the number keys.

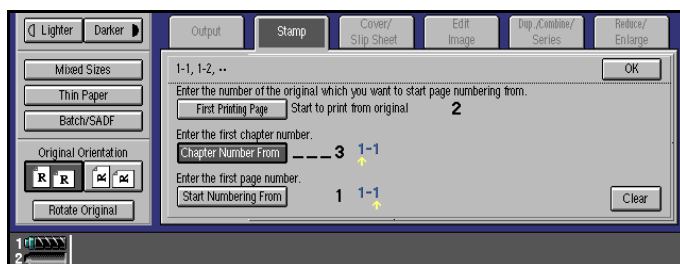

- 3 Press the [Start Numbering From] key, then enter the page number to start numbering using the number keys.

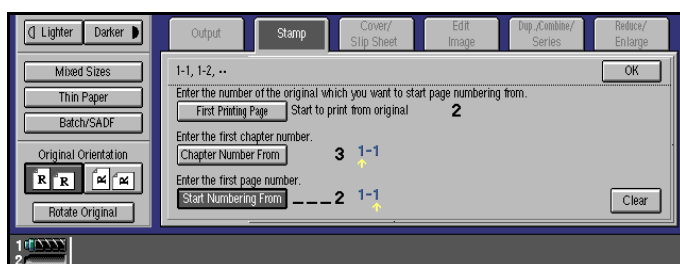

- 4 Press the [OK] key.

- 5 Set your originals then press the [Start] key.

- 1 Press the [Change] key.

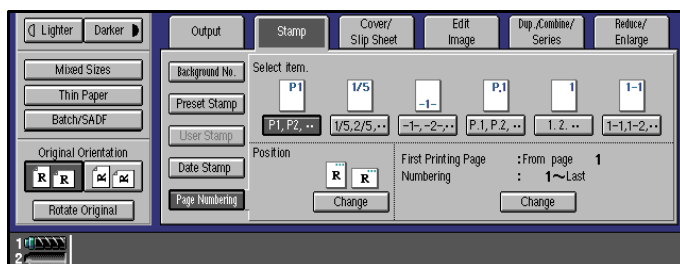

- 2 Select desired position of Page Numbering with the keys on the display.

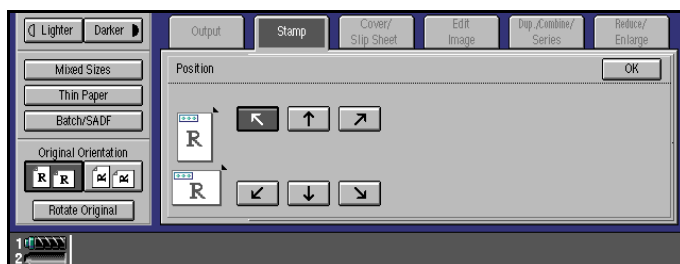

Choosing How Copies Are Delivered

You can have copies delivered in the following ways:

- ❖ **Shift Tray Off In Sort/Stack**
Use this function have copies delivered with no shift in the Sort/Stack mode.
- ❖ **Separation**
You can insert separation sheets between sets or jobs.
- ❖ **Copy Face Up**
Use this function to deliver copies face up (in reverse order).

Shift Tray Off In Sort/Stack

1 Press the [Output] key.

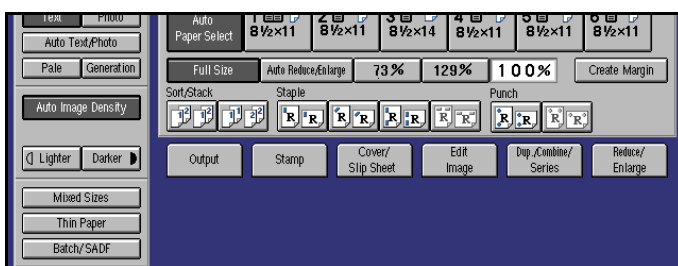

2 Press the [Shift Tray Off In Sort/Stack] key.

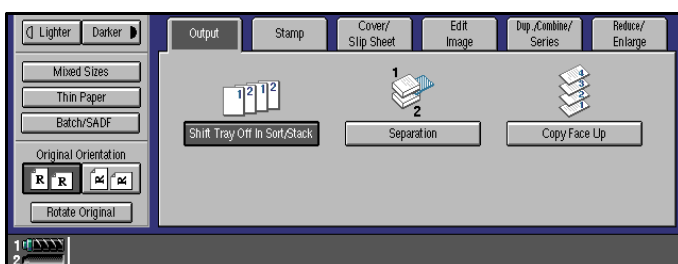

3 Set your originals then press the [Start] key.

Separation

Use this feature to have separation sheets inserted between sets.

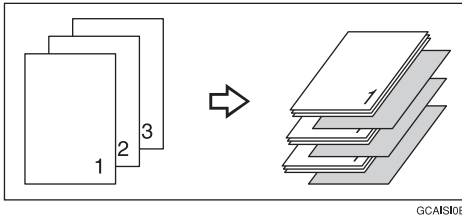

2

Preparation

Before selecting this function, set the tray for separation sheets. See “Tray Paper Settings” in the System Settings manual.

Note

- You can choose to have separation sheets inserted between every set, or every n sets. See⇒ P.328 “Input/Output”.

1 Press the [Output] key.

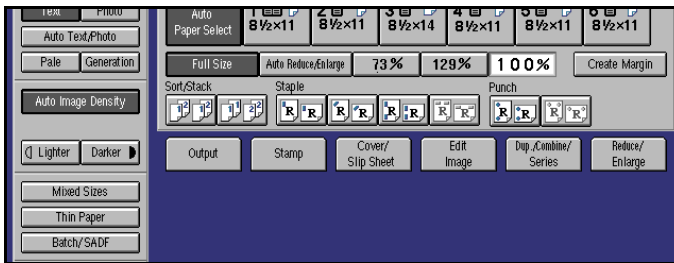

2 Press the [Separation] key.

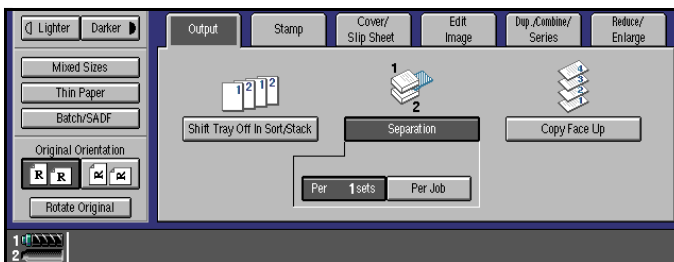

3 Select the type of job separation.

4 Set your originals then press the [Start] key.

Copy Face Up

Use this function to reverse the order of copies.

Note

- If you combine this function with the Duplex function, the copying may take a certain time.

1 Press the [Output] key.

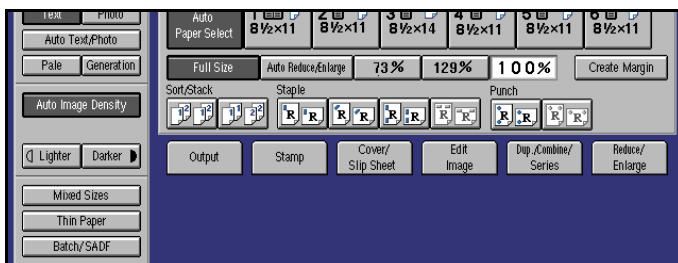

2 Press the [Copy Face Up] key.

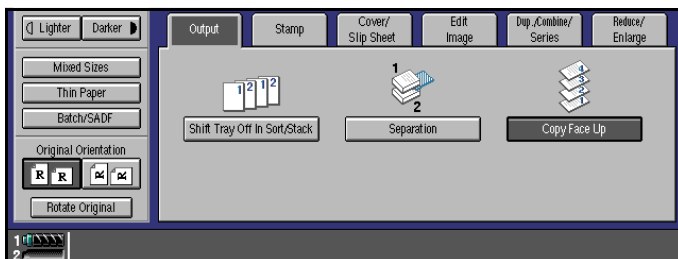

3 Set your originals then press the [Start] key.

Combination Chart

The combination chart given below shows which modes can be used together.

○	means that these modes can be used together.
→	means that these modes cannot be used together. The mode after you select will be the mode you're working in.
×	means that these modes cannot be used together. The mode before you select will be the mode you're working in.

2

The following shows the combinations of functions.

		Mode after you Select																					
		Batch/SADF	Mixed Sizes	Selecting Original	Selecting Copy Paper	Auto Reduce/Enlarge	Sort	Stack	Staple	Punch	Reduce/Enlarge	Create Margin	Zoom	Size Magnification	Duplex	Combine	Series	Book	Cover/Slip Sheet	Edit Image	Stamp	Output	
Mode before you Select	Batch/SADF	○	○	○	○	○	○	○	○	○	○	○	○	○	○	○	○	○	○	○	○	○	○
	Mixed Sizes	○	○	○	○	○	○	○	○	○	○	○	○	○	○	○	○	○	○	○	○	○	○
	Selecting Original	○	○	○	○	○	○	○	○	○	○	○	○	○	○	○	○	○	○	○	○	○	○
	Selecting Copy Paper	○	○	○	○	○	○	○	○	○	○	○	○	○	○	○	○	○	○	○	○	○	○
	Auto Reduce/Enlarge	○	○	○	○	○	○	○	○	○	○	○	○	○	○	○	○	○	○	○	○	○	○
	Sort	○	○	○	○	○	○	○	○	○	○	○	○	○	○	○	○	○	○	○	○	○	○
	Stack	○	○	○	○	○	○	○	○	○	○	○	○	○	○	○	○	○	○	○	○	○	○
	Staple	○	○	○	○	○	○	○	○	○	○	○	○	○	○	○	○	○	○	○	○	○	○
	Punch	○	○	○	○	○	○	○	○	○	○	○	○	○	○	○	○	○	○	○	○	○	○
	Reduce/Enlarge	○	○	○	○	○	○	○	○	○	○	○	○	○	○	○	○	○	○	○	○	○	○
	Create Margin	○	○	○	○	○	○	○	○	○	○	○	○	○	○	○	○	○	○	○	○	○	○
	Zoom	○	○	○	○	○	○	○	○	○	○	○	○	○	○	○	○	○	○	○	○	○	○
	Size Magnification	○	○	○	○	○	○	○	○	○	○	○	○	○	○	○	○	○	○	○	○	○	○
	Duplex	○	○	○	○	○	○	○	○	○	○	○	○	○	○	○	○	○	○	○	○	○	○
	Combine	○	○	○	○	○	○	○	○	○	○	○	○	○	○	○	○	○	○	○	○	○	○
	Series	○	○	○	○	○	○	○	○	○	○	○	○	○	○	○	○	○	○	○	○	○	○
	Book	○	○	○	○	○	○	○	○	○	○	○	○	○	○	○	○	○	○	○	○	○	○
Cover/Slip Sheet	○	○	○	○	○	○	○	○	○	○	○	○	○	○	○	○	○	○	○	○	○	○	
Edit Image	○	○	○	○	○	○	○	○	○	○	○	○	○	○	○	○	○	○	○	○	○	○	
Stamp	○	○	○	○	○	○	○	○	○	○	○	○	○	○	○	○	○	○	○	○	○	○	
Output	○	○	○	○	○	○	○	○	○	○	○	○	○	○	○	○	○	○	○	○	○	○	

3. Document Server

Overview

The Document Server enables you to save documents in the machine memory and then edit and print them as you want.

There are two ways to save documents:

- Scanning from the ARDF
- Scanning from the exposure glass

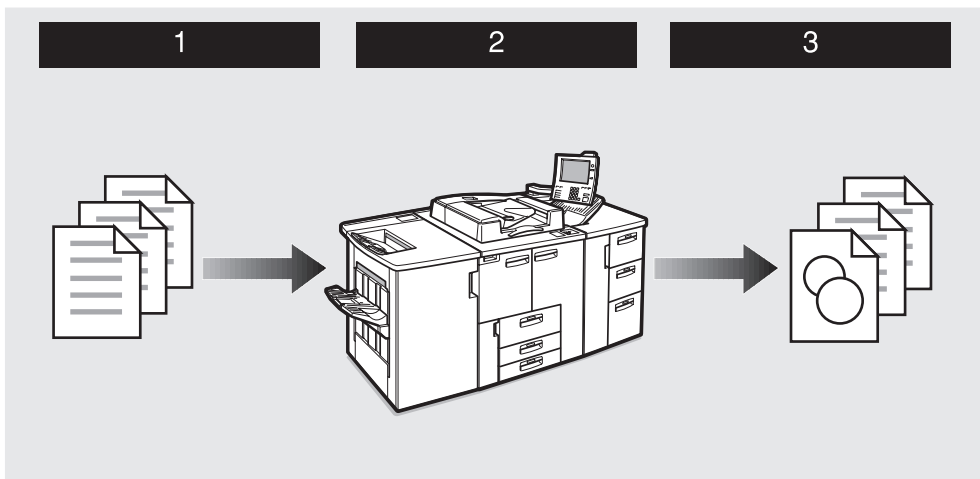

GCDCSV0E

1 Prepare the documents you want to save.

2 Save the documents.

The documents are saved in the machine memory.

3 Print the documents.

You can print saved documents with any settings you desire at any time.

Document Server Features

The following printing features are available with the Document Server.

❖ **Scanning Originals**

See ⇒ P.199 *“Scanning Originals”*

❖ **Printing Saved Documents**

See ⇒ P.204 *“Printing Saved Documents”*

Document Server Editor Features

The following features are available with the Document Server Editor.

❖ **Changing File Names**

See ⇒ P.211 *"Changing File Names"*

❖ **Merging Documents**

See ⇒ P.214 *"Merging Documents"*

❖ **Inserting Files**

See ⇒ P.217 *"Inserting Files"*

❖ **Deleting Pages**

See ⇒ P.220 *"Deleting Pages"*

❖ **Deleting Saved Documents**

See ⇒ P.224 *"Deleting Saved Documents"*

❖ **Moving/Copying Files**

See ⇒ P.229 *"Moving/Copying Files"*

Features and Benefits

On Demand Printing

Use to print any saved document as required.

❖ Your current situation might be...

- When you need to print multiple sets of documents double-sided and stapled together, you normally print the originals, make duplex copies and then staple them together manually.

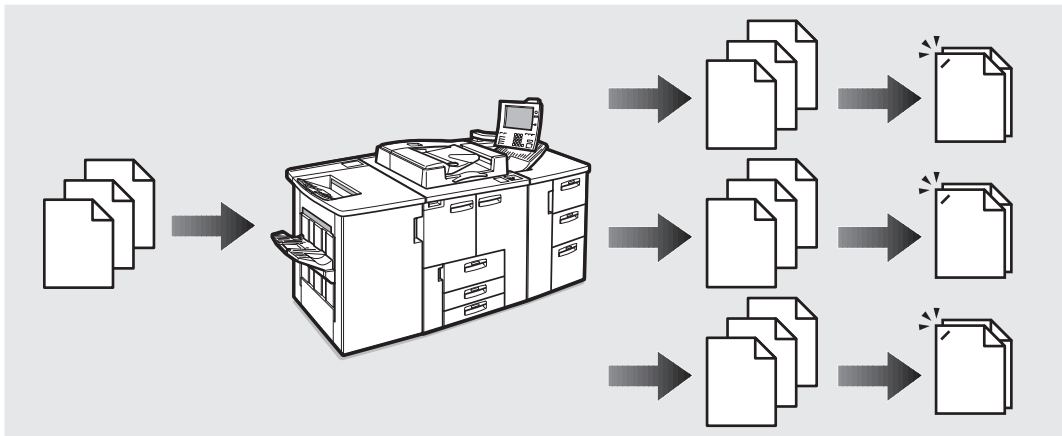

GCDCSV4J

❖ With the Document Server

If you save your document in the Document Server, you can print it out at any time with the necessary print settings, such as duplex and stapling. Your documents will not be confused with those of others in the exit tray.

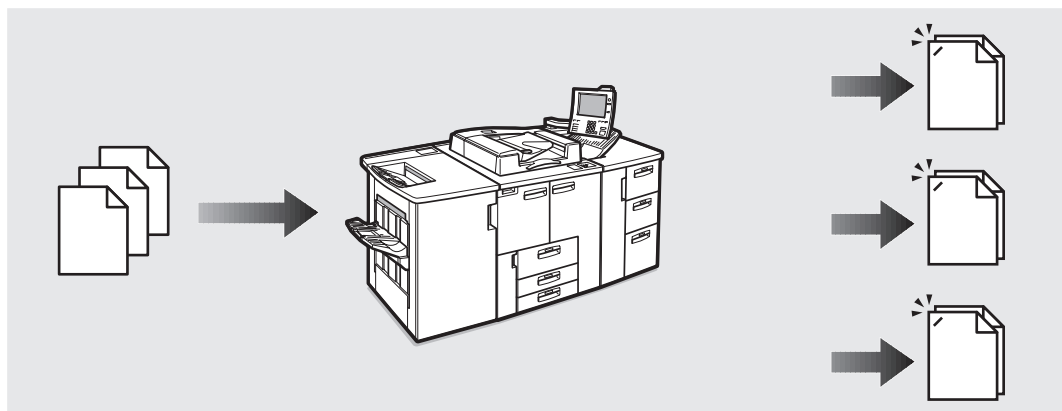

GCDCSV5J

Note

- Punching requires the installation of the optional Punch kit in the Finisher.
- You can specify a password to prevent others from printing a reading documents.

Scanned File Printing

You can combine multiple scanned documents into one print set.

❖ **Your current situation might be...**

You want to combine several originals that are different in density, size, and paper weight, e.g.

- Damaged and pasted originals
- Photo originals
- One sided originals
- Two sided originals

3



GCDCSV3E

❖ **With the Document Server**

You can save the originals individually by selecting the best settings for each original, and then edit them as a file.

It doesn't matter whether the originals were scanned using the document feeder (ADF) or the exposure glass. As you can specify the print order for several files, you can combine them as you want and print them as a file.

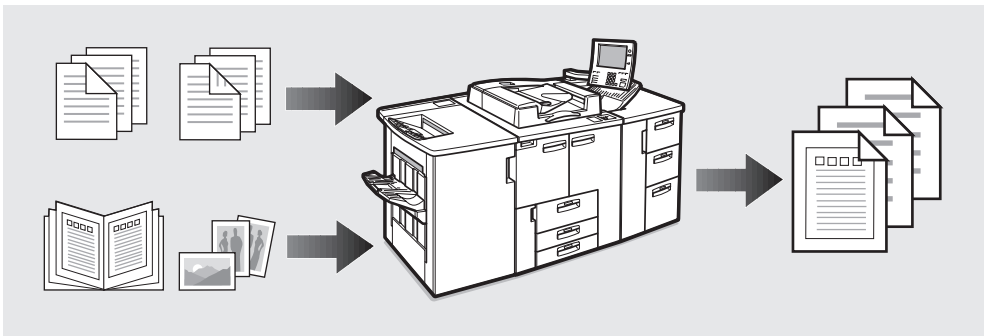

GCDCSV4E

You can check the print result by printing a sample set before making a large print run by pressing the **[Sample Copy]** key.

If you aren't satisfied with the print result of some pages of the set, you have only to scan that part again.

Scanning Originals

Use this feature to scan originals you want to save in the Document Server from the machine control panel. The originals can be set either on the exposure glass or into the document feeder (ARDF).

The saved documents will automatically be named in the scanning order: "Scan001", "Scan002" and so on.

Note

- The maximum number of files you can store is 250 in the HDD, 50 in the CD-RW (option).
- Make sure the machine's date setting is correct before scanning originals. See "Date" and "Time" in the System Settings manual.
- Retain your original documents after storing them.
- You can set the timer to delete the documents stored in the document server. See "Auto File Delete" ⇒ P.330 "Document Server"
- You can select whether **[Store And Print]** or **[Store Only]** is displayed in the initial display with the User Tools .⇒ P.330 "Document Server"

1 Press the **[Document Server]** key.

The "File List" menu appears.

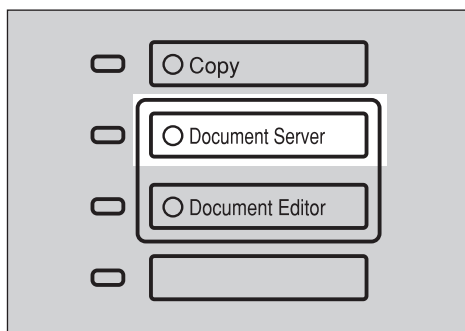

2 Press the [Store Originals] key.

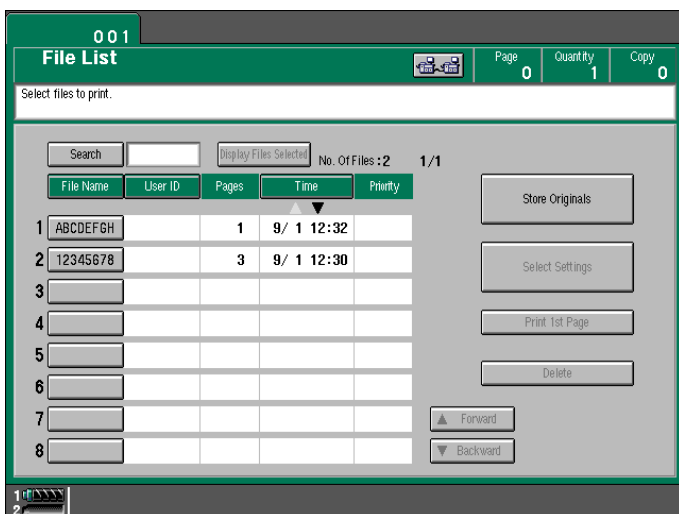

The “Store Originals” menu appears.

3 Enter a file name.

Note

- If you do not wish to register a file name, go to step 4.
- If you do not register a file name, it is stored automatically.

To set the file name

1 Press the [Change] key.

2 Enter the new file name using the letter keys on the display panel.

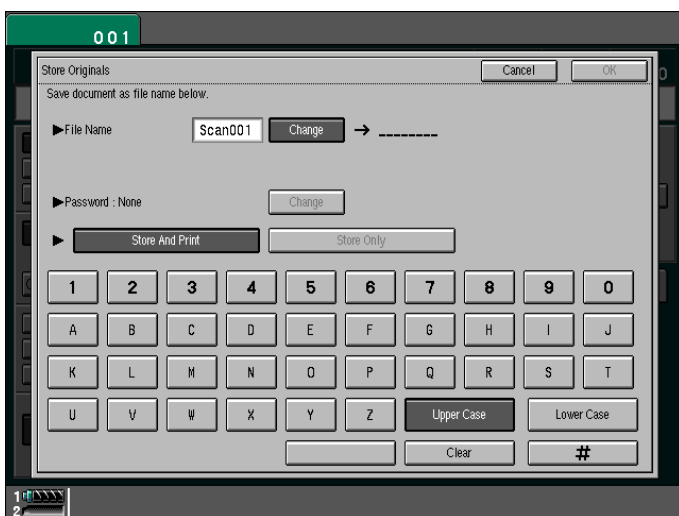

Note

- You can enter up to 8 letters.
- To change the letter entered, press the **[Clear]** key and enter the new letter.
- You can register a file name identical to an existing file name. It is not overwritten.

3 Press the **[#]** key.

4 Enter your password.

Note

- If you do not wish to enter a password, go to step **5**.

To set the password

1 Press the **[Change]** key.

2 Enter the password using number keys (4 digits).

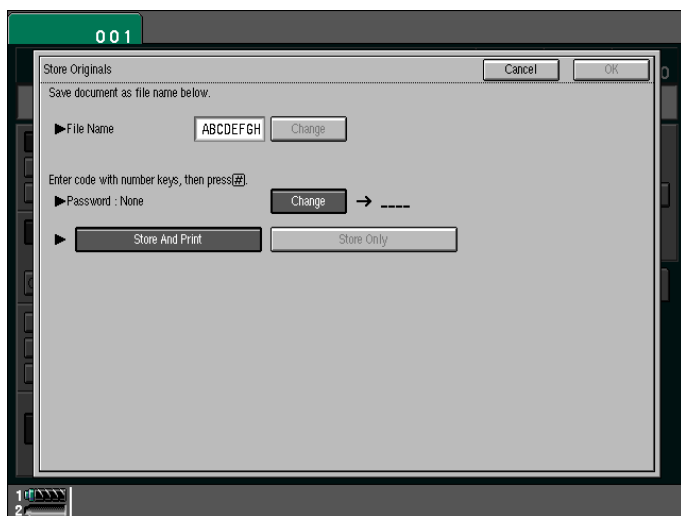
**Note**

- To change the number entered, press the **[Clear]** key and enter the new number.

3 Press the **[#]** key.

5 Select **[Store And Print]** or **[Store Only]**.

1

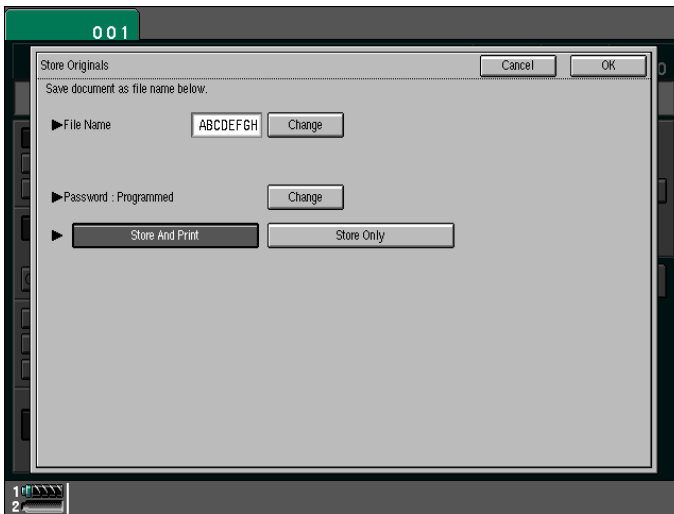

3

6 Press the **[OK]** key.

Note

- To stop scanning originals, press the **[Cancel]** key.

7 Set your originals either on the exposure glass or into the document feeder (ADF).

Reference

For more information on the types of originals that can be set and how to set them, see “Setting Originals” ⇒ P.26 “Setting Originals”.

8 Make any desired settings.

Limitation

- You cannot use the Booklet function.

Note

- The settings remain in the machine after scanning. You can change these settings when you want to print next time.

9 Press the **[Start]** key.

Note

- To stop scanning, press the **[Stop]** key. A message appears on the display. Press the **[Print]** key to continue, and press the **[Stop]** key to store.

If you set the original on the exposure glass

- 1 After scanning all pages, press the [Storing Complete] key.

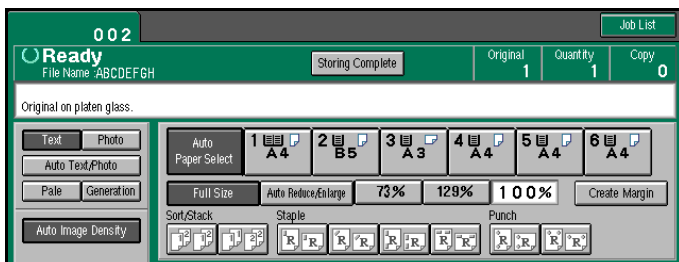

If you set the original in the document feeder

- 1 After scanning all pages, the "File List" display appears.

Printing Saved Documents

Preparation

If you select multiple files, the scan settings of the first selected file are used when printing.

To check these settings, press the **[Select Settings]** key or use the Sample Copy feature .

You can print any of the documents saved in the Document Server.

Follow these steps to select a document and print it out.

3

1 Press the **[Document Server]** key.

The “File List” menu appears.

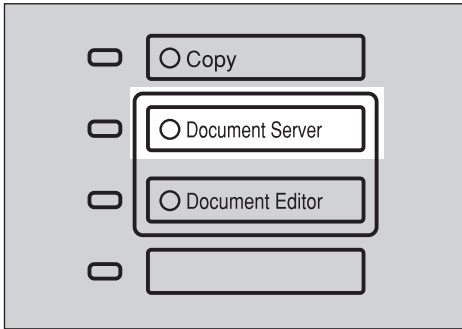

ZAJ5100N

2 Select the document you want to print.

Press the line for the document if it appears on the display.

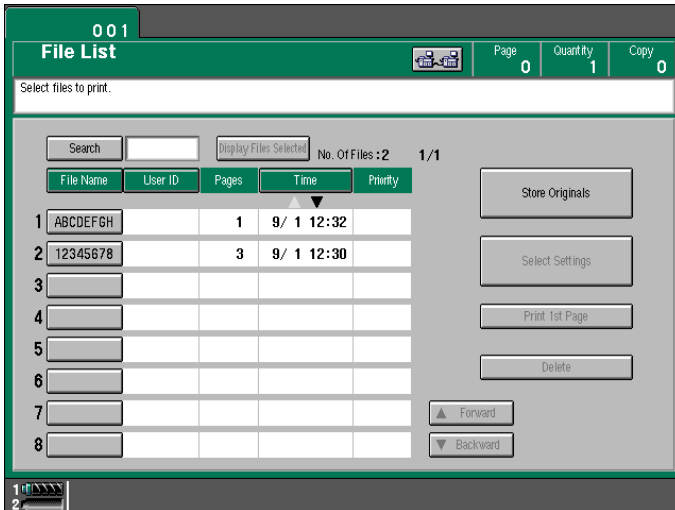

The selected line is highlighted.

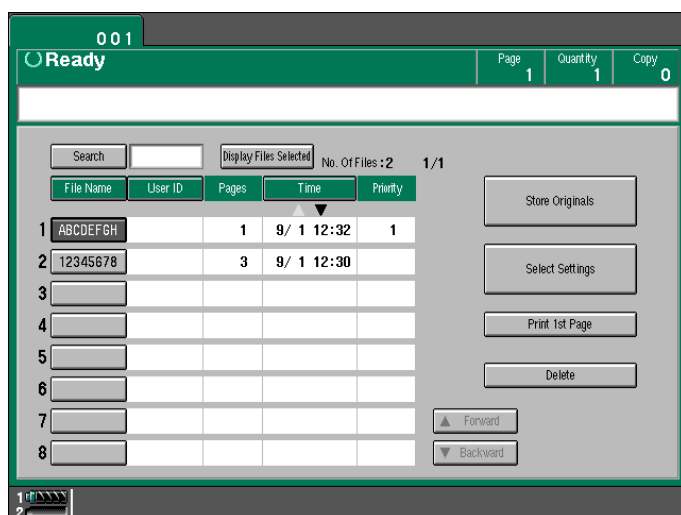

Note

- You can select multiple files.
- If the file name you desire is not shown and more than 9 files are stored, scroll through the list with the [▼ Forward] and [▲ Backward] keys. The “No. Of Files” display shows the total number of files followed by which page of the search results is currently shown.
- If you can't recognize the document by its name, you can print the first page to check the contents. Press the line for the desired document, and press the [Print 1st Page] key.
- Press the selected line again to cancel the print job.
- If the “Enter Password” menu appears, enter your password using the number keys then press the [OK] key. To delete an entered password, press the [Clear] key.
- You can sort the files in alphabetical or reverse-alphabetical order. Press the keys above the file list. See “File List Sort Priority” ⇒ P.330 “Document Server”
- Press the [Display Files Selected] key to display only the selected files.

To search by file name

Note

- If you enter the filename (up to 8 letters), all the filenames beginning with these letters are displayed. For example, if you enter “ABC”, then all filenames beginning with the “ABC” are displayed.

1 Press the [Search] key.

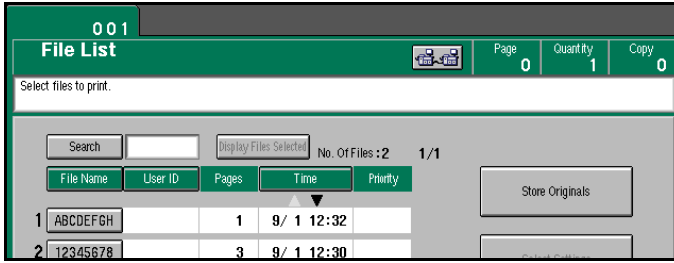

2 Enter the file name using the letter keys.

3

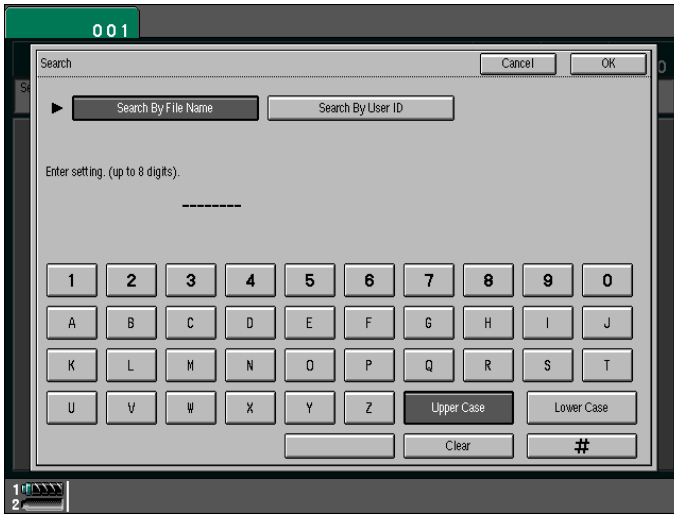

3 Press the [OK] key.

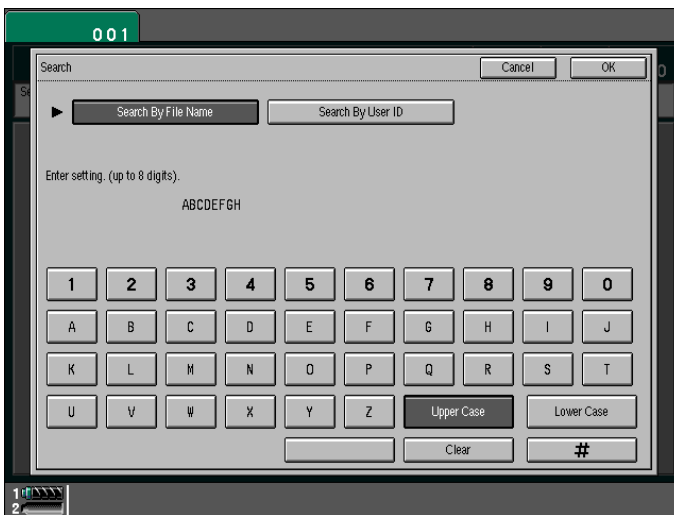

Only the files beginning with the letters appears on the File List.

4 Select the line for the document you want to print.

When the “Enter Password” menu appears

1 Enter your password using the number keys.

Note

To delete an entered value, press the **[Clear]** key. To cancel selection of the file, press the **[Cancel]** key.

2 Press the **[OK]** key.

3 To print more than one document, repeat step 2 to select the desired documents in the order you want to print them out.

The selected order is shown in the priority column next to the selected document(s).

Note

To change the print order, press the highlighted lines to deselect the files, then select them again in the order you want to print.

To cancel selection, press the **[Clear Modes]** key.

4 If you need to change any of the print settings, press the **[Select Settings]** key.

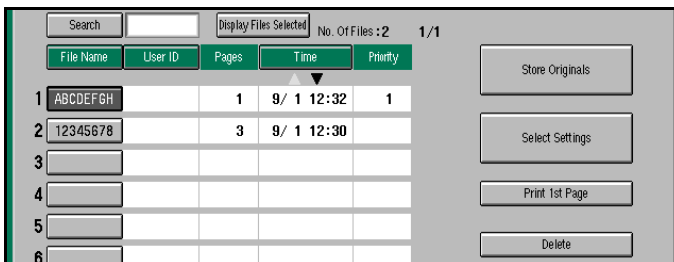

The “Set Job” menu appears.

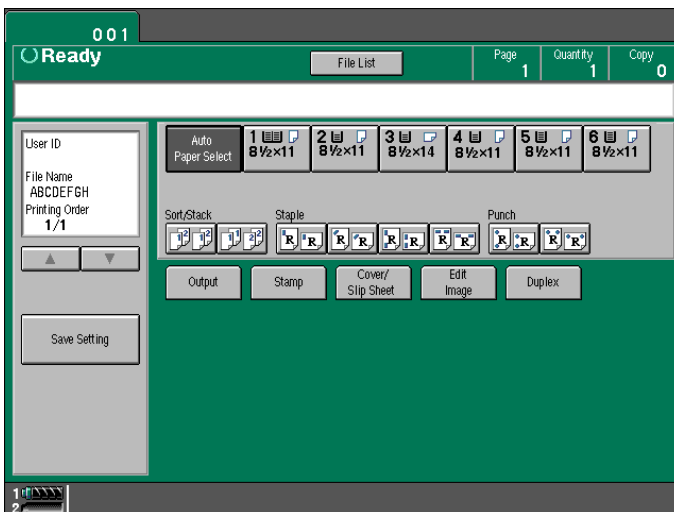

Note

- To save the new settings, press the **[Save Setting]** key.

5 Enter the required number of prints with the number keys.

Up to 9999 can be entered.

Note

- If you print more than one set using the Sort function, you can check the print result by printing out only the first set ⇒ P.209 “Sample Printing”.
- To delete the entered value, press the **[Clear]** key.

6 Press the **[Start]** key.

The machine starts printing.

Note

- To pause the print job, press the **[Stop]** key. In the confirmation dialog, press the **[Print]** key to resume printing or press the **[Cancel]** key to cancel printing.
- After the print job is completed, the “File List” menu appears.

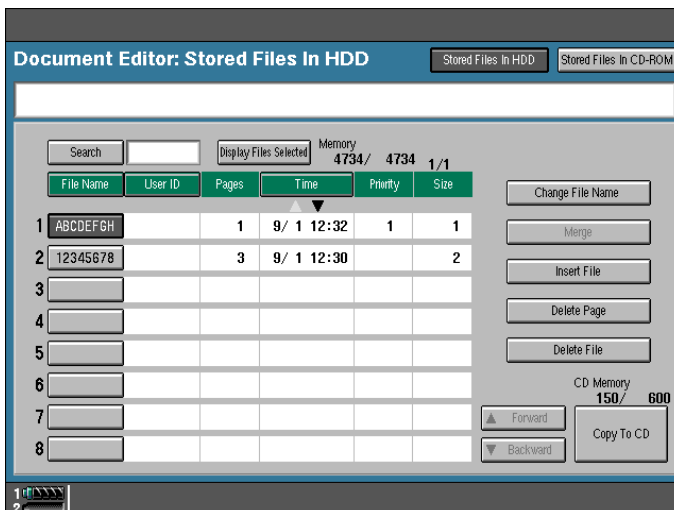
7 To delete all the documents you have printed, press the **[Delete]** key.

8 Press the **[Delete]** key.

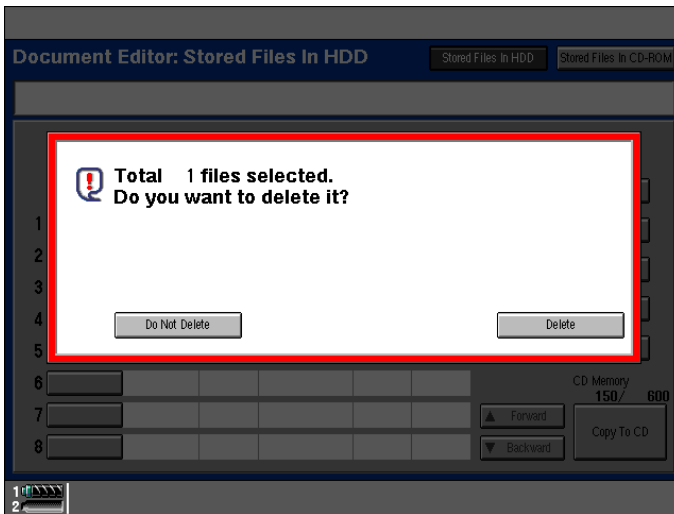

Note

- If you do not want to delete the files, press the **[Do Not Delete]** key.
- You cannot delete file that are currently begin used by other functions.

Sample Printing

If you print multiple sets using the Sort function, you can check if the print order or the print settings are correct by printing out only the first set using the **[Sample Copy]** key.

Limitation

- Sample Printing can be done only when you are using the Sort function.

1 Press the **[Sample Copy]** key.

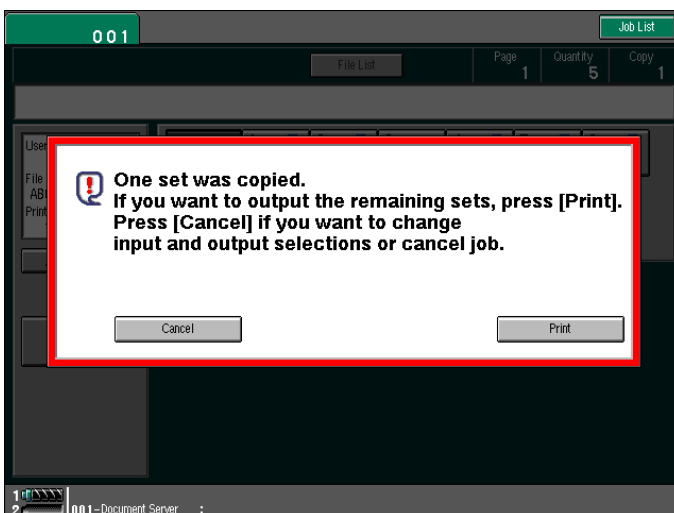

After the first set is printed out, press the **[Print]** key to print the rest of the print job. Press the **[Cancel]** key to cancel it and return to the “Set Job” menu where you can adjust the settings.

Print First Page

You can print the first page of the document selected in the “File List” menu to check the contents.

If more than one document is selected, the first page of each document is printed.

3

1 Select the desired document(s), and press the **[Print 1st Page]** key.

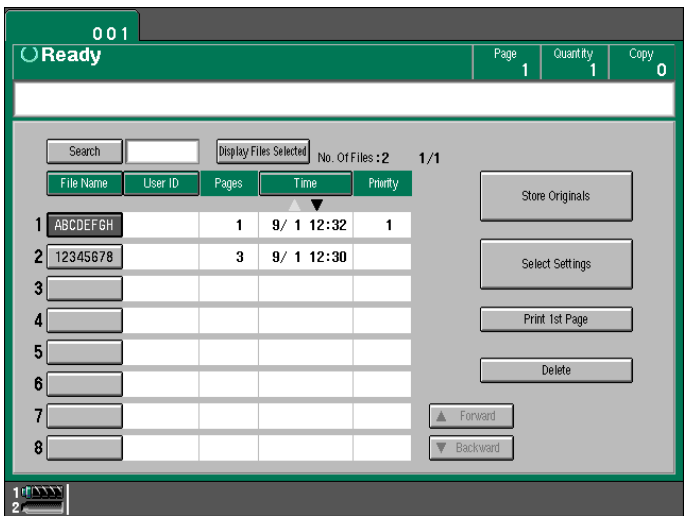

2 Press the **[Start]** key.

The first page is printed out.

Changing File Names

Follow these steps to edit the filenames of documents stored in the Document Server.

Note

- You can register a file name identical to an existing file name. It is not overwritten.

1 Press the **[Document Editor]** key.

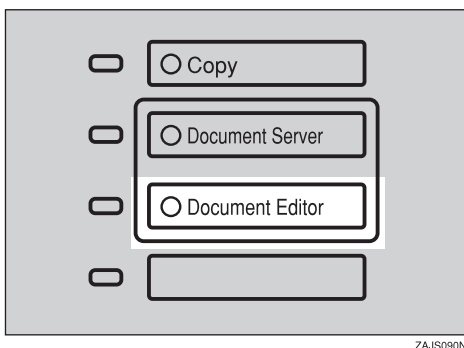

ZAJ5090N

2 Press the line showing the document you want to change the file name of. The selected line is highlighted.

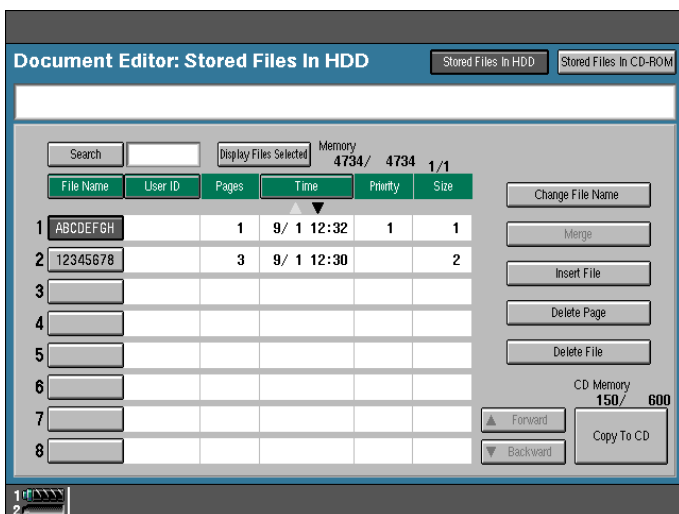

Note

- If you stored a password, enter the password using the letter keys on the display panel. Then press the **[OK]** key ⇒ P.207 “When the “Enter Password” menu appears”.

3 Press the [Change File Name] key.

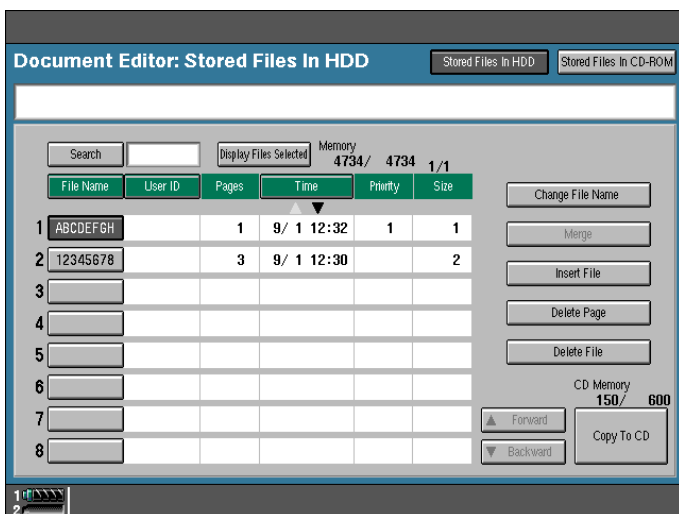

4 Enter the new file name using the letter keys. Then press the [#] key.



Note

- To delete entered letters, press the [Clear] key.
- To cancel this operation, press the [Cancel] key.

5 Press the [OK] key.

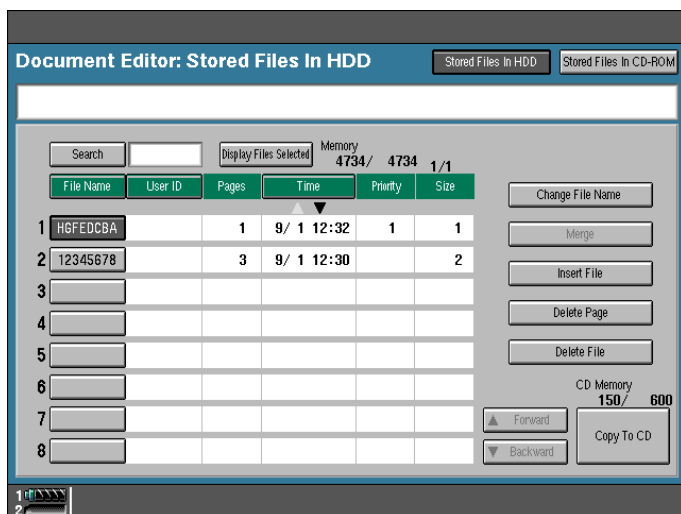

Note

- If the selected file is currently being used by another function, you cannot change the file name.

Merging Documents

You can merge the two or more stored documents.

Follow these steps to merge the documents.

! Limitation

- If you want to merge multiple documents, it may take a certain time. And you cannot operate during the time.

1 Press the **[Document Editor]** key.

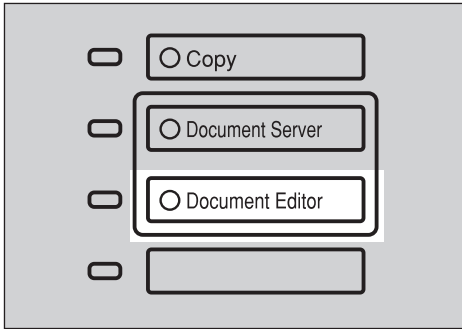

ZAJ5090N

2 Press the lines showing the documents you want to merge.

Selected lines are highlighted.

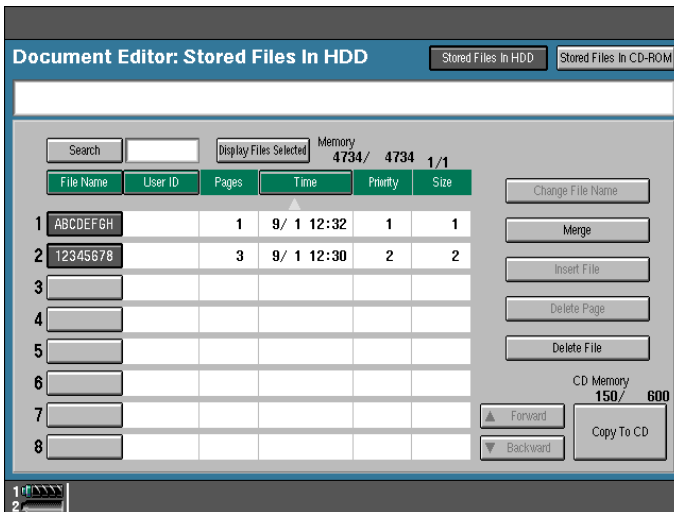

Note

- The documents are merged in the order you select them.
- The scan settings of the document you select first are applied to the merged documents.

3 Press the [Merge] key.

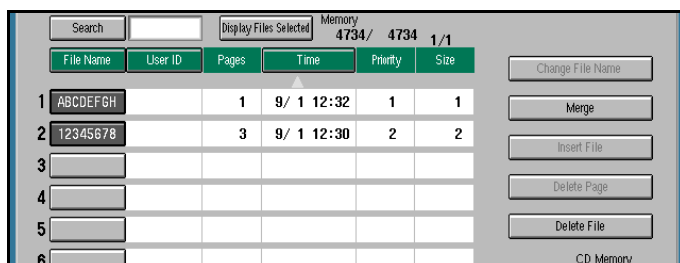

4 Enter the new file name using the letter keys.

Note

- If you do not wish to register a file name, go to step 5.
- If you do not register a new file name, the filename of the document selected first is stored automatically.

To change the file name

1 Press the [Change] key.

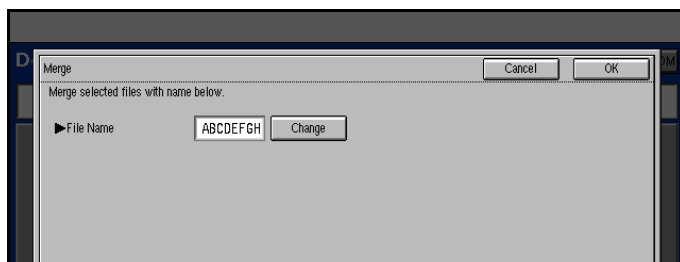

2 Enter the file name using the letter keys.

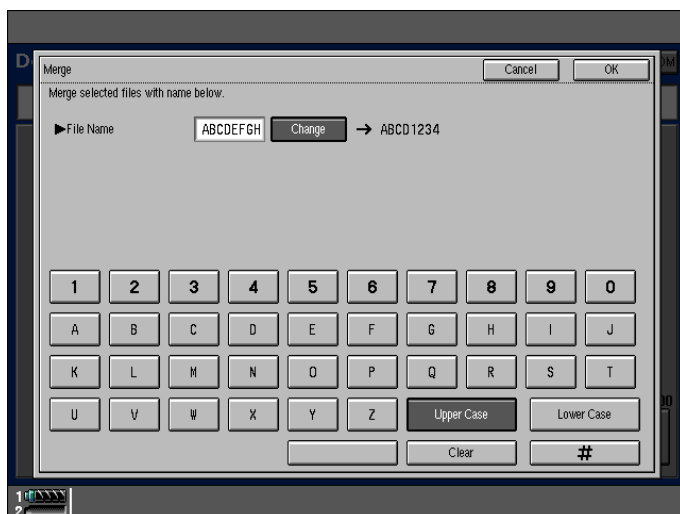

 **Note**

- You can enter up to 8 letters.
- To change the letter entered, press the **[Clear]** key and enter the new letter.

3 Press the **[#]** key.

5 Press the **[OK]** key.

 **Note**

- To cancel merging, press the **[Cancel]** key.
- You cannot recover the original two files from the merged file.
- You cannot merge documents that are correctly being used by another function.

Inserting Files

You can insert a file into files already stored in the Document Server. Follow these steps to insert your file.

- 1 Press the **[Document Editor]** key.

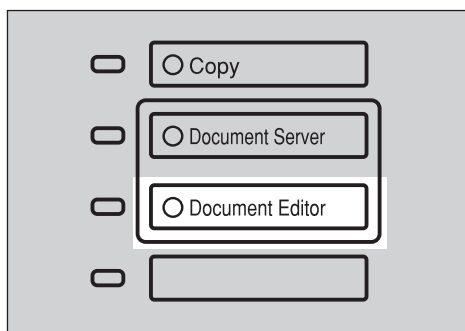

ZAJ5090N

- 2 Press the line showing the document to be inserted in. The selected line is highlighted.

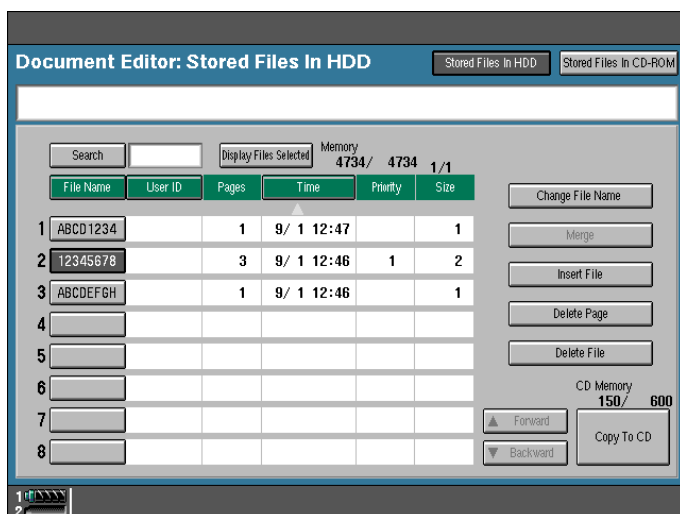

- 3 Press the **[Insert File]** key.

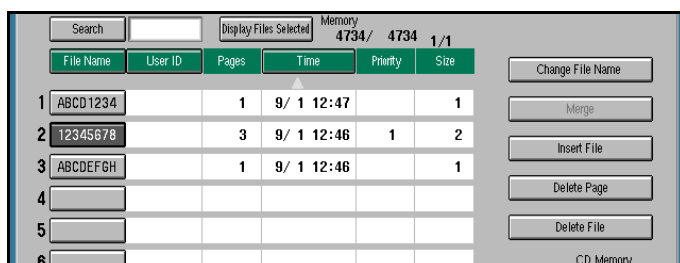

4 Select the file you want to insert into.

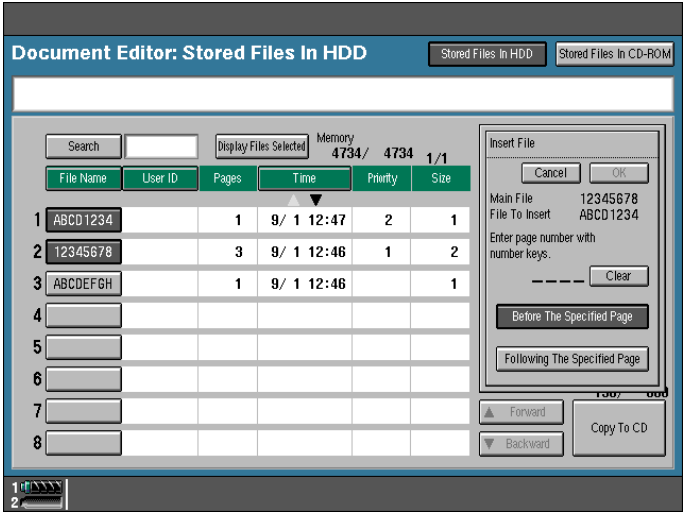

3

5 Enter the page number to insert the file using number keys.

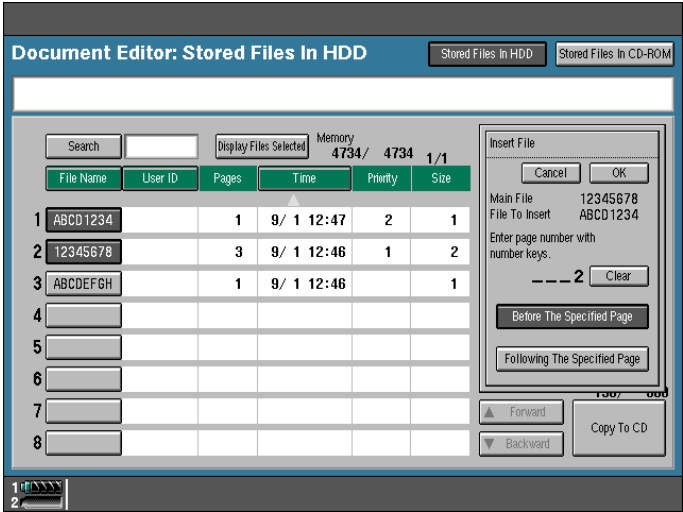

 **Note**

- To change the entered number, press the **[Clear]** key.

6 Press the [Before The Specified Page] or [Following The Specified Page] key.

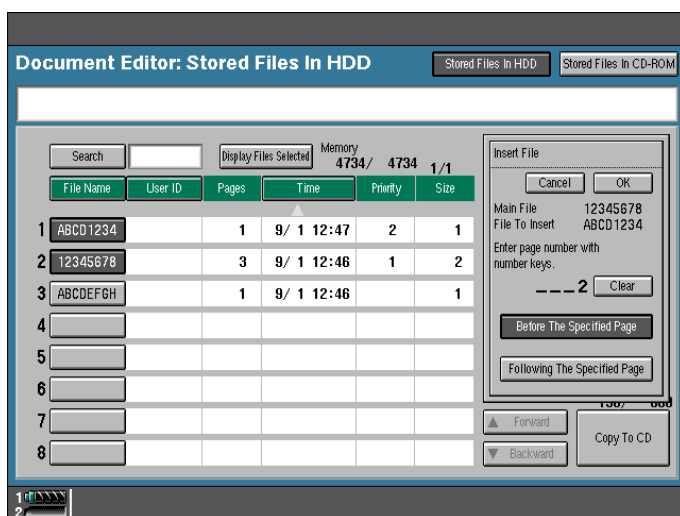

7 Press the [OK] key.

Note

- To cancel insertion of the file, press the [Cancel] key.
- You cannot recover the original file from the new file.
- You cannot insert files into a file that is currently being used by another function.

Deleting Pages

Follow these steps to delete pages from a file stored on the Document Server.

Preparation

To check on the page numbers print the file. See⇒ P.204 “Printing Saved Documents”

1 Press the **[Document Editor]** key.

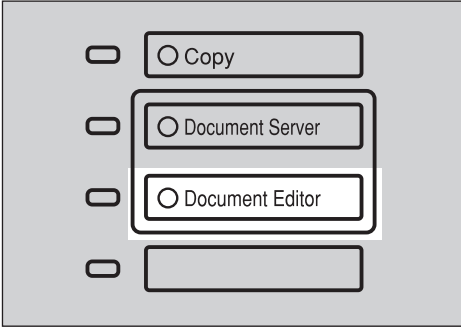

ZAJ5090N

2 Press the line showing the document containing the pages you want to delete.

The selected line is highlighted.

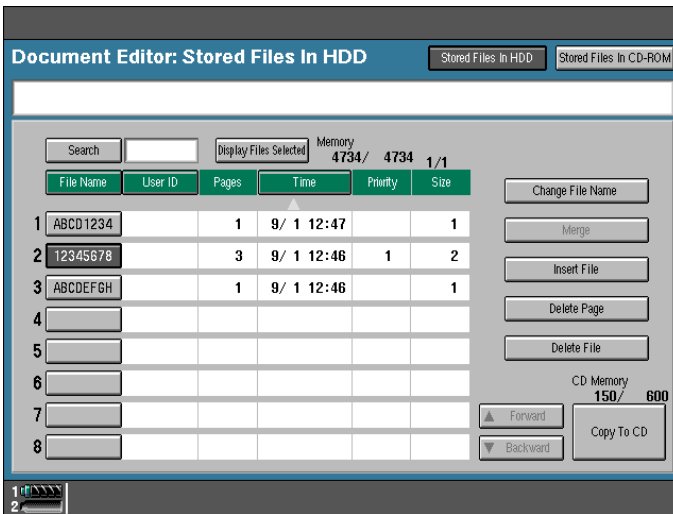

3 Press the [Delete Page] key.

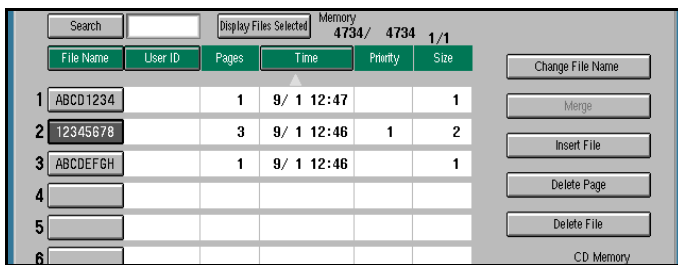

4 Enter the page number you want to delete using the number keys.

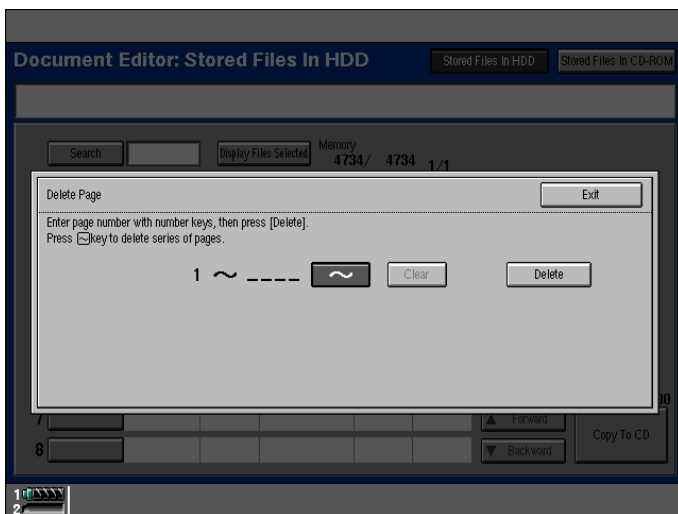

Note

□ To stop deleting pages, press the [Exit] key.

5 If you want to delete a series of pages, press the [~] key. Then enter the last page number you want to delete.

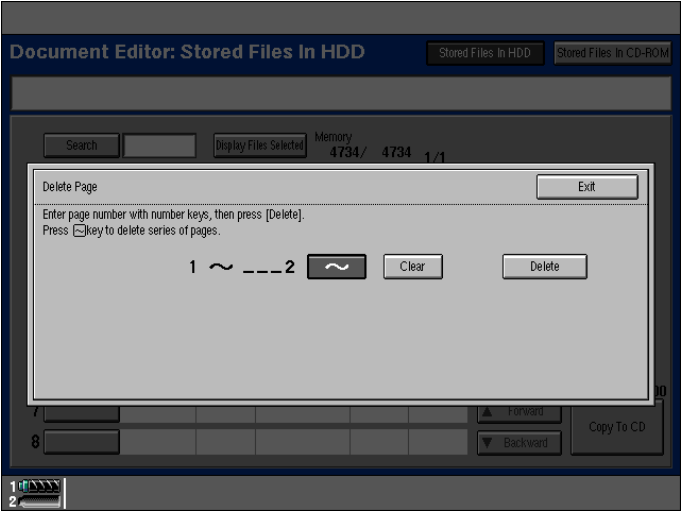

3

Note

- If you want to only 1 page, go to step **6**.
- If you enter the last page number, the file is deleted.

6 Press the [Delete] key.

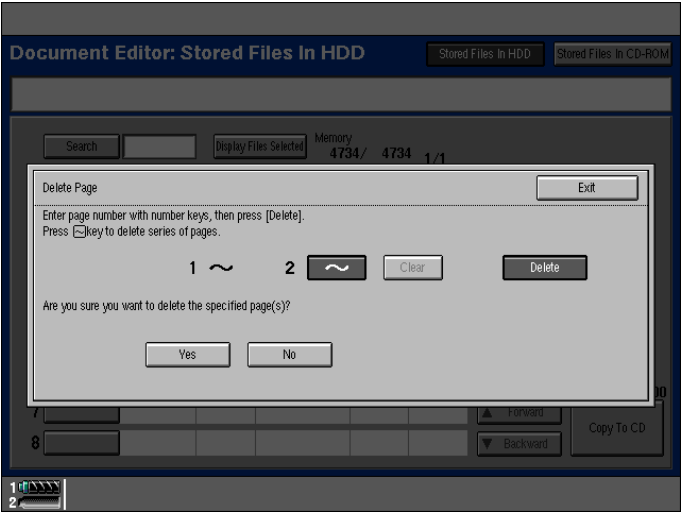

7 Press the [Yes] key.

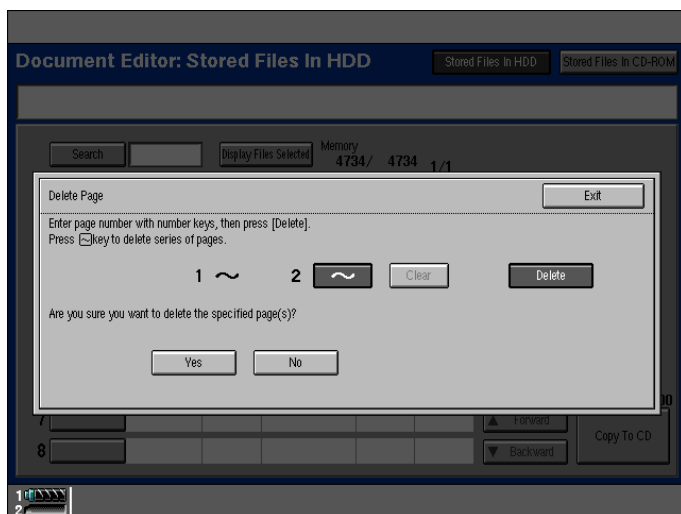

Note

- To cancel the delete operation, press the **[No]** key.
- You cannot restore deleted pages.
- You cannot delete pages from a file that is currently being used by another function.

Deleting Saved Documents

This chapter describes how to delete saved documents.

Important

- You can save up to 250 documents on the Document Server. No more documents can be saved when there are 250 documents stored so you should delete any unnecessary documents.
- You can delete each document from the HDD automatically after a certain times. To turn this feature on, See ⇒ P.330 “Document Server”.

Note

- You can delete all the saved documents in one operation. See ⇒ P.330 “Document Server”

Follow these steps to delete saved documents.

Deleting Saved Documents in HDD

1 Press the **[Document Editor]** key.

The “File List” menu appears.

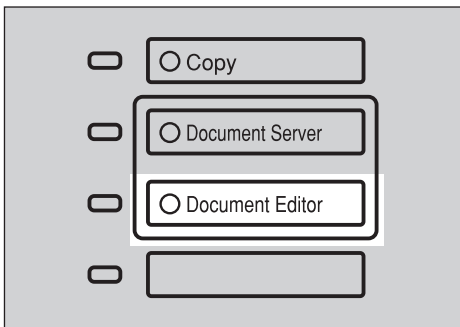

ZAJ5090N

- 2** Select a document you want to delete by touching the name of it.

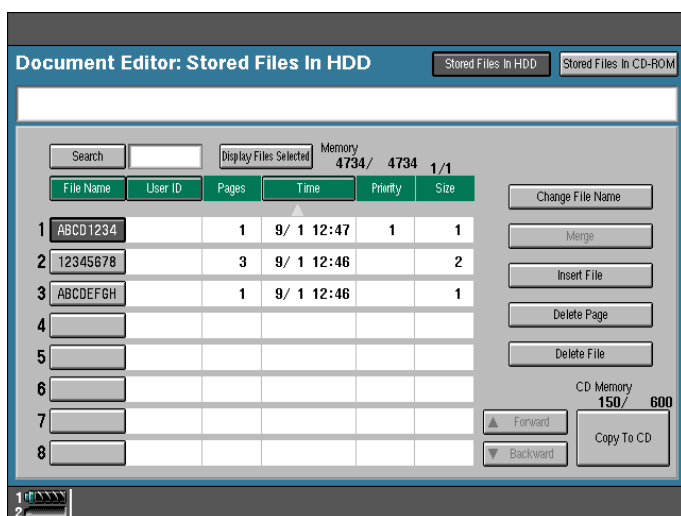

The selected name is highlighted.

Note

- If the document name you desire is not shown in the display, scroll through the list with the [**▲Forward**] or [**▼Backward**] keys.
- If you select a document which requires a password, the “Password” window appears. Input the password using the number keys then press the [**OK**] key. If you input the wrong password, press the [**Clear**] key and try again. To cancel selection of a document, press the [**Cancel**] key.
- To cancel a selected document, press the highlighted line again.

- 3** Repeat step **2** if you want to select more than one document.

- 4** Press the [**Delete File**] key.

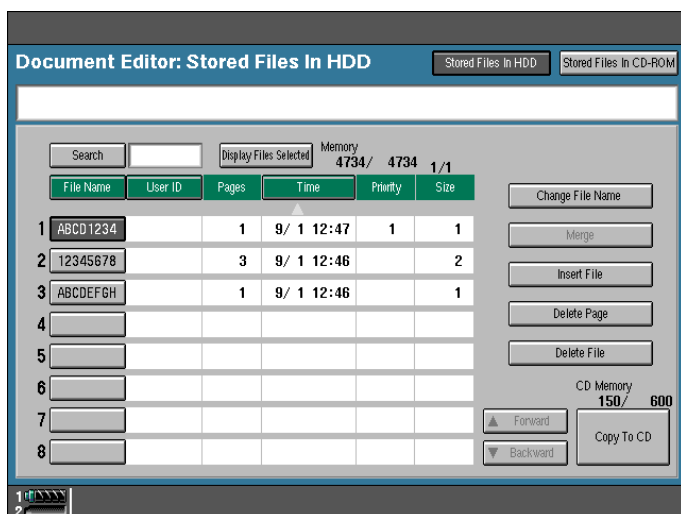

A confirmation dialog appears.

5 Press the [Delete] key to delete the document(s).

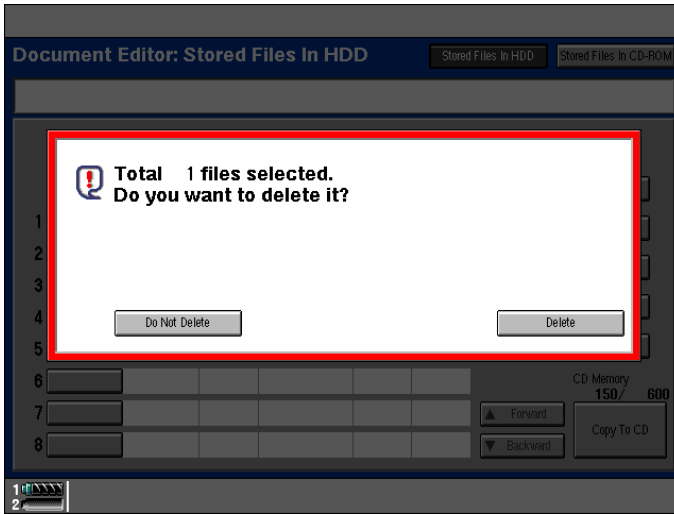

3

Note

You cannot delete files that are currently being used by other functions.

Deleting Saved Documents on the CD-ROM

1 Press the [Document Editor] key.

The "File List" menu appears.

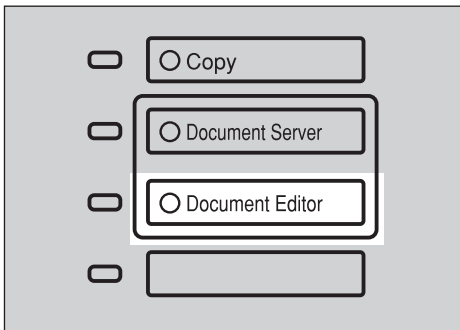

2 Press the [Stored Files in CD-ROM] key.

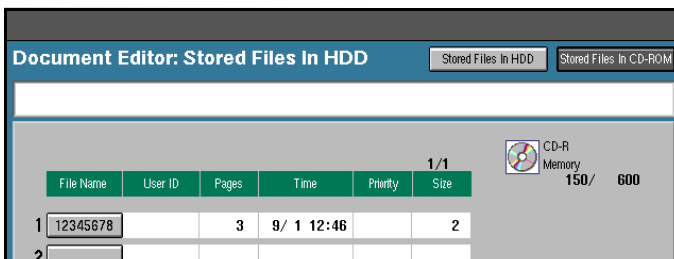

- 3** Select a document you want to delete by touching the name of it.

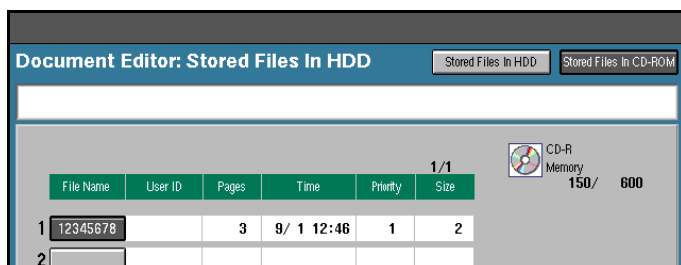

The selected name is highlighted.

Note

- If the document name you desire is not shown in the display, scroll through the list with the [**▲Forward**] or [**▼Backward**] keys.
- If you selected a document which requires a password, the "Password" window appears. Input the password using the number keys then press the [**OK**] key. If you input the wrong password, press the [**Clear**] key and try again. To cancel a selection of a document, press the highlighted line again.

- 4** Repeat step **3** if you want to select more than one document.

- 5** Press the [**Delete File**] key.

A confirmation dialog appears.

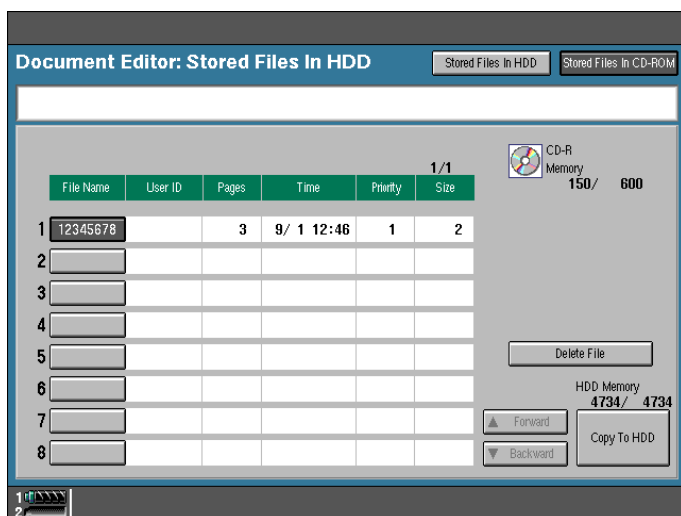

6 Press the [Delete] key to delete the document(s).

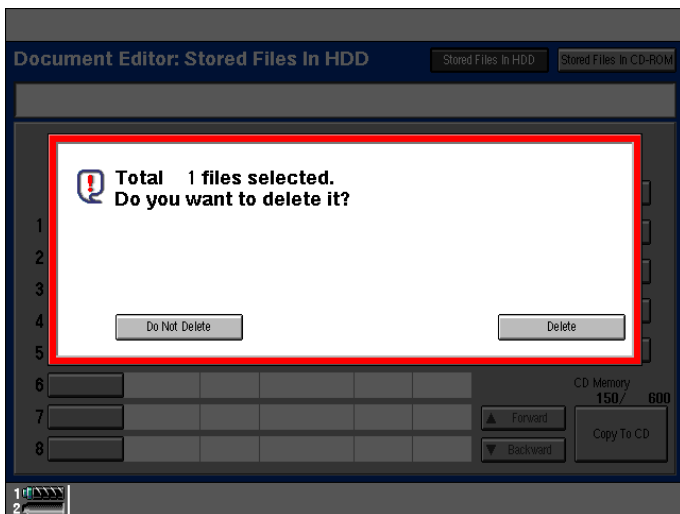

3

 **Note**

- You cannot delete files that are currently being used by other functions.

Moving/Copying Files

To use this function, optional CD-RW is required.

This section describes how to move files from the HDD to the CD-ROM and vice-versa.

Preparation

Make sure the CD-RW power is turned on.

Make sure the CD-R/RW disk is set in the CD-RW.

Make sure an unformatted CD-R/RW disk, or a disk previously used with this machine is inserted in the CD-RW.

This equipment can be installed with an optional CD-RW. However, it is prohibited by copyright law to store or make copies of such works as books, paintings or photographs as digital data or to make copies of CD-RW using the CD-RW except when you are allowed to do so for personal use only by law or by the owner of the copyright.

Important

- Do not turn the main machine power or CD-RW power off when the Document Editor indicator is lit or data might be lost.

Moving/Copying files from HDD to CD-ROM

- 1** Press the **[Document Editor]** key.

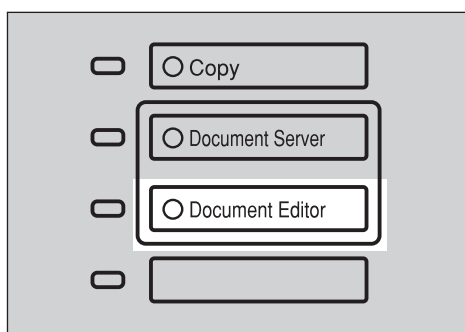

ZAJ5090N

2 Press the [Stored Files In HDD] key.

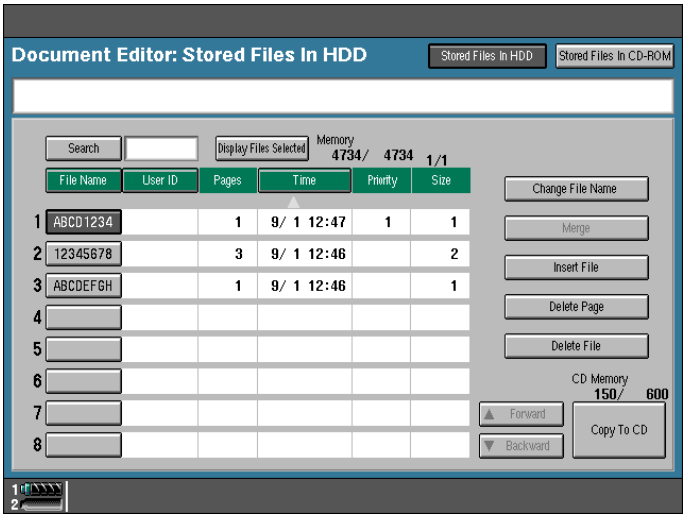

3

3 Select the file you want to move or copy.

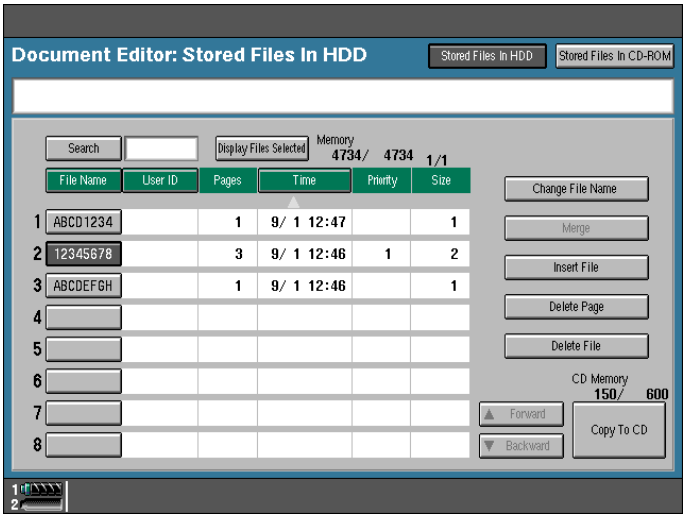

Note

- If the file size is larger than free space on the CD-ROM, you cannot move or copy this file.

- 4** Press the [Stored Files In CD-ROM] key.

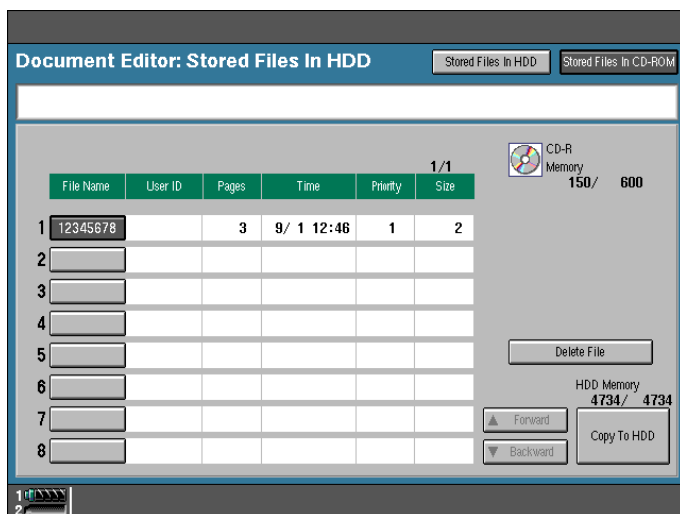

- 5** Enter the new file name using the letter keys.

Note

- If you do not wish to register a file name, go to step **6**.

To set the file name

- 1** Press the [Change] key.
- 2** Enter the file name using the letter keys on the display panel.

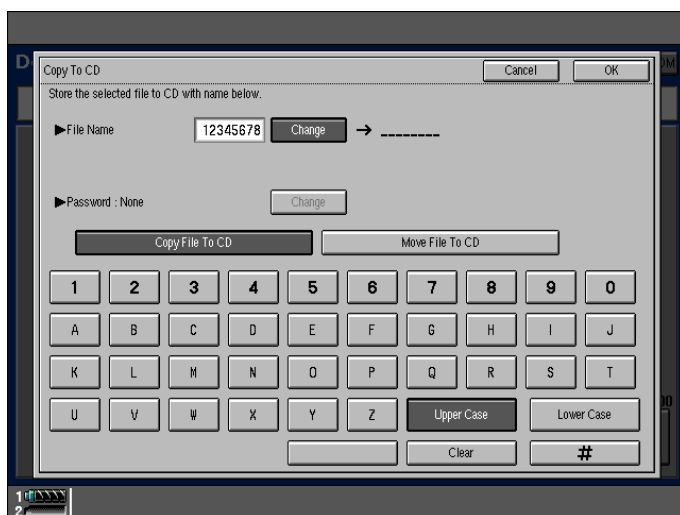

Note

- You can enter up to 8 letters.
 - To change the letter entered, press the [Clear] key and enter a new letter.
 - To cancel this operation, press the [Cancel] key.
- 3** Press the [#] key.

6 Enter your password using the number keys.

Note

- If you do not wish to change the password, go to step **7**.

To set the password

1 Press the [Change] key.

2 Enter your password using the number keys.

3

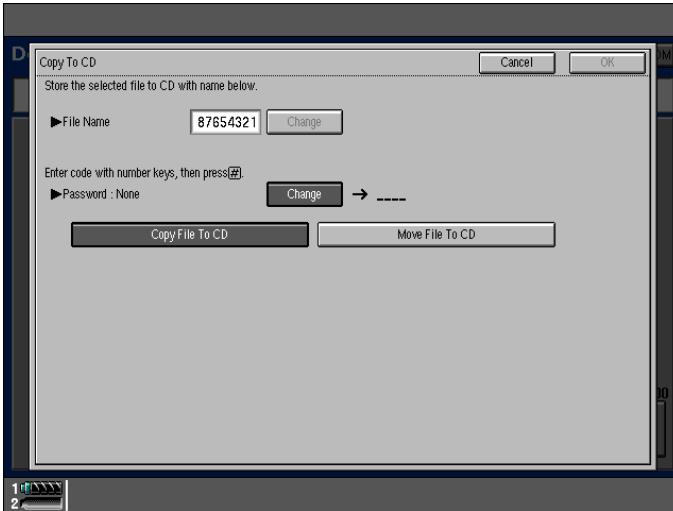

Note

- To delete an entered value, press the [Clear] key.

3 Press the [#] key.

7 Press the [Copy File To CD] or [Move File To CD] key.

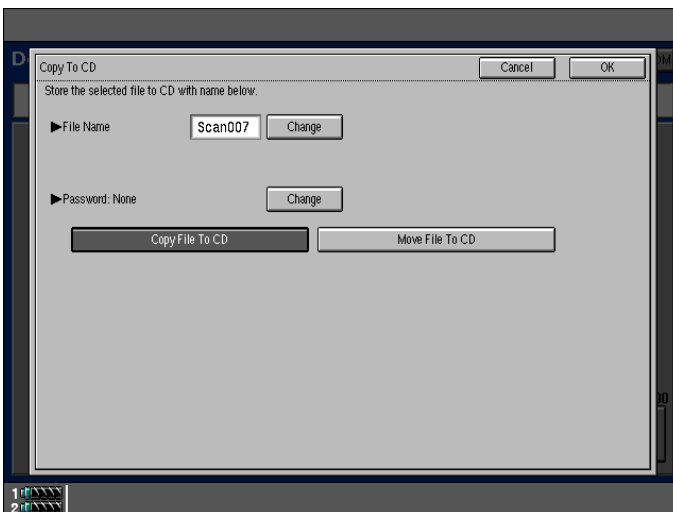

8 Press the [OK] key.

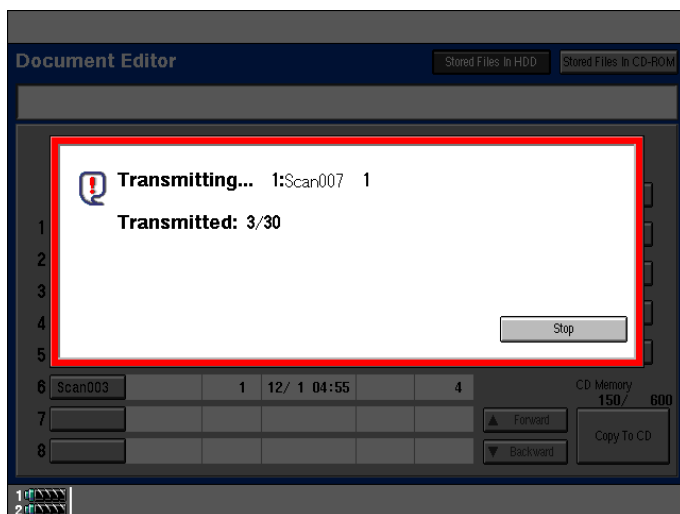

3

Note

- To cancel this operation, press the **[Stop]** key.
- You cannot move or copy files that are currently being used by other functions.

Moving/Copying files from CD-ROM to HDD

1 Press the **[Document Editor]** key.

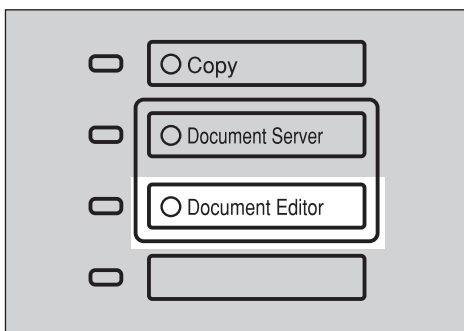

ZAJ5090N

2 Press the **[Stored Files In CD-ROM]** key.

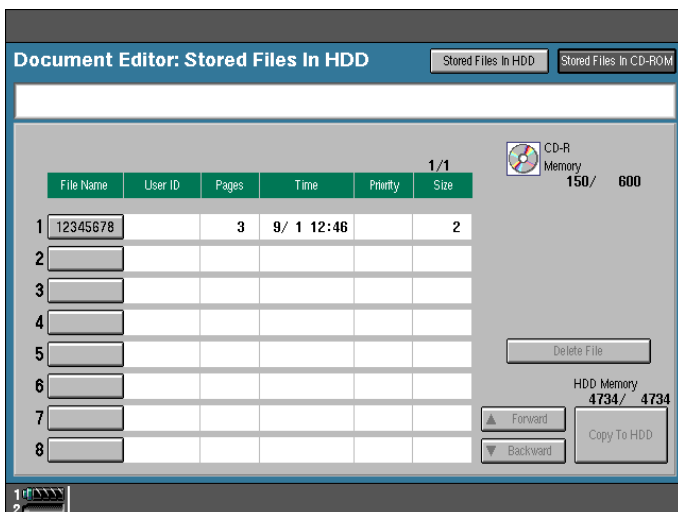

3

3 Select the file you want to move or copy.

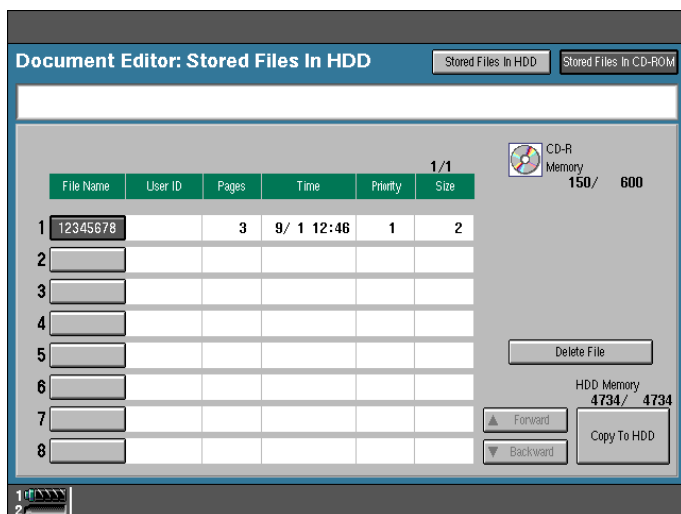

Note

- If the file size is larger than the free space on the HDD, you cannot move or copy this file.
- If a document is being stored during the move or copy operation and the HDD or CD-ROM runs out of space, the move or copy may not be successful.

4 Press the [Stored Files In HDD] key.

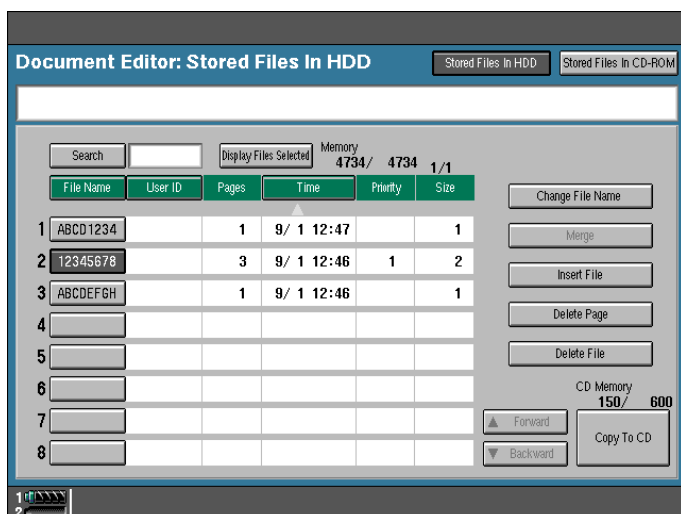

5 Enter the new file name using the letter keys.

Note

- If you do not wish to register a file name, go to step 6.

To set the file name

- 1 Press the **[Change]** key.
- 2 Enter the file name using the letter keys on the display panel.

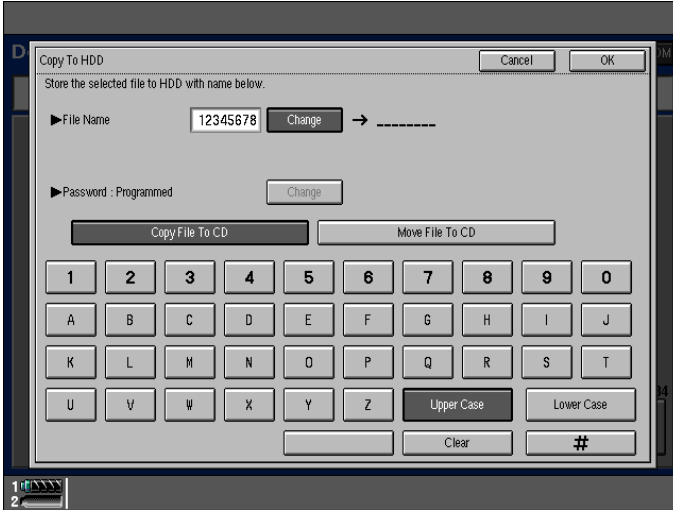

Note

- You can enter up to 8 letters.
- To change the letter entered, press the **[Clear]** key and enter the new letter.

- 3 Press the **[#]** key.

- 6 Enter your password using the number keys.

Note

- If you do not wish to change the password, go to step 7.

To set the password

- 1 Press the **[Change]** key.

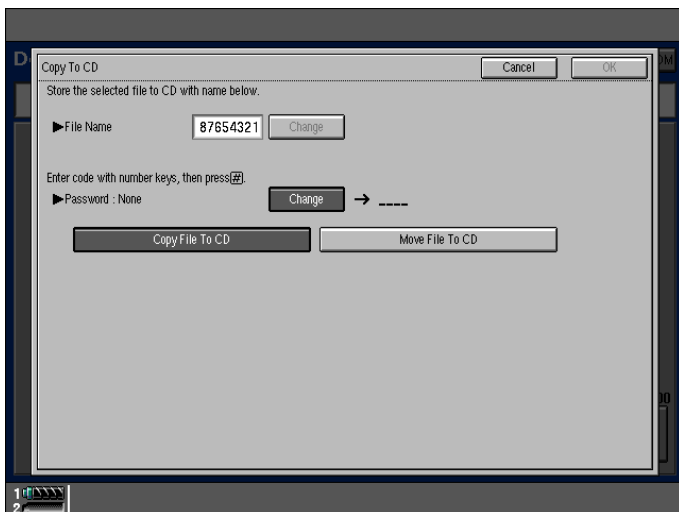
2 Enter your password using the number keys.

3

Note

- To delete an entered value, press the **[Clear]** key.

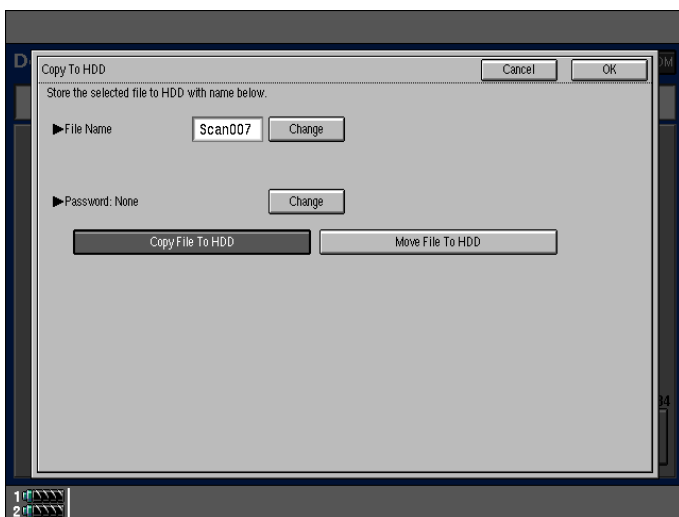
3 Press the **[#]** key.**7** Press the **[Copy File To CD]** or **[Move File To CD]** key.

8 Press the [OK] key.

3

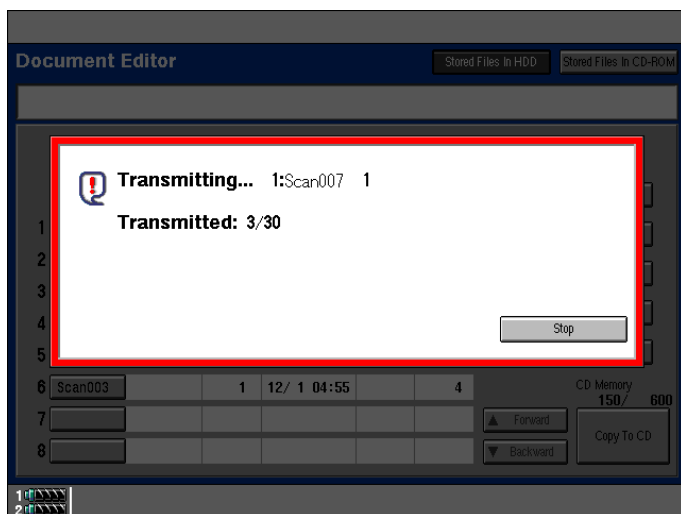

Note

To cancel this operation, press the [Stop] key.

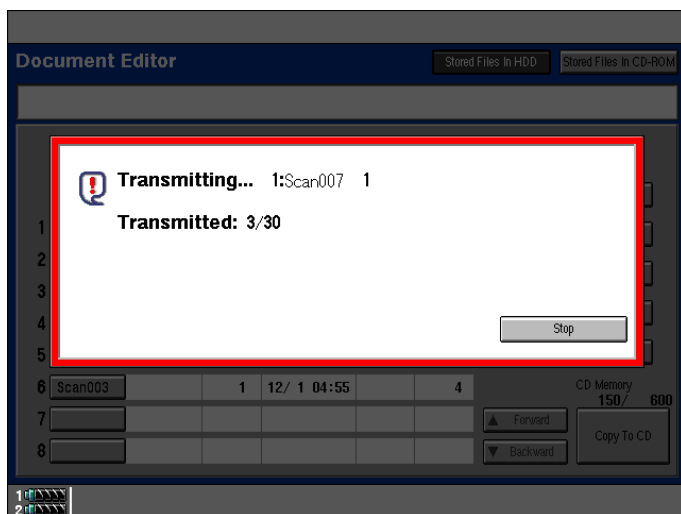

You cannot move or copy files that are currently in use by other functions.

4. Connect Copy (Option)

What is Connect Copy?

Connect Copy is a feature that allows you to connect two machines using a cable. When you set up your copy job on one machine (the master unit), data is transferred to the other machine (the sub-unit) so that copies can be made on both machines simultaneously.

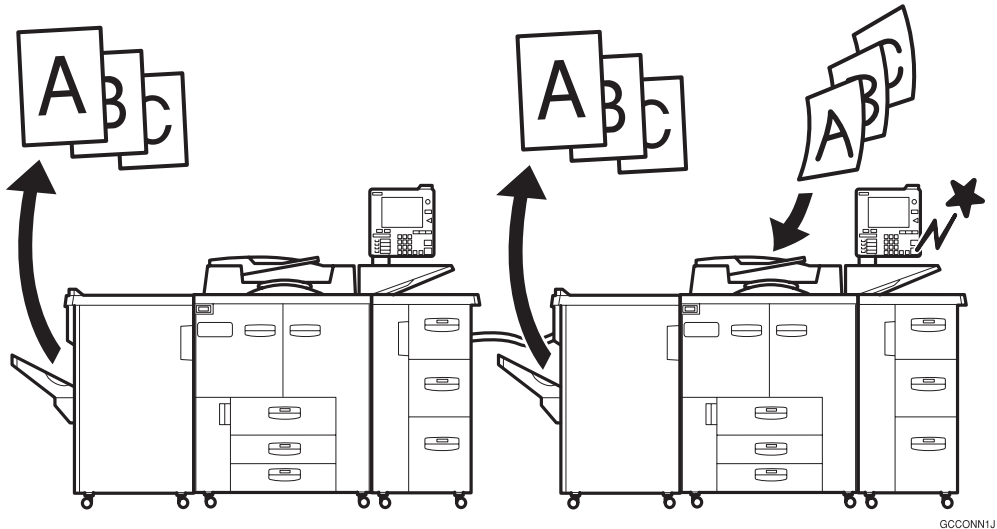

Connect copy benefits

Connect Copy provides the following benefits:

❖ **High-speed copying for greater productivity**

For large volume copy runs, two connected machines form a single system that can complete the job in a shorter time. A 170 copies/minute (A4 □, 8¹/₂" × 11" □ size) speed will be available.

❖ **Auto-backup system for less participation of operators**

Even if one machine stops because of a paper jam, it has run out of toner, or run out of paper, the other machine will take over and finish the job automatically. If the stopped machine is recovered, the machines will allocate the job again and continue using Connect Copy to complete the job in a way that results in maximum productivity.

 **Note**

- You cannot make other copy jobs when the two machines are connected.
- The two machines automatically share the job for maximum productivity.
-  key is described **[Connect]** key in this manual.
- To use the two machines separately, press the **[Connect]** key to disconnect them.

How Connect Copy Works

In this manual we refer to the two machines as the master unit and sub-unit respectively.

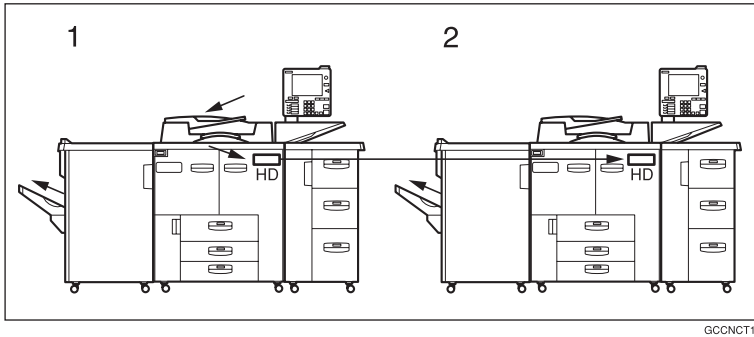

1. Master unit

2. Sub-unit

❖ Copy

As your original is scanned, the image data is stored on the master unit hard disk and transferred simultaneously to the sub-unit hard disk. As soon as scanning has finished, copying starts.

❖ Copy Server

The master unit transfers the image data stored in the hard disk to the sub-unit hard disk.

As soon as transferal has completed, copying starts.

Note

Transfer of image data may take some time.

The master unit is the machine at which you press the **[Connect]** key to enter Connect Copy mode. When you do this, the other machine becomes the sub-unit. You can use either machine as the master unit or sub-unit, but you cannot change the relationship without exiting Connect Copy mode first.

Connectable Copier Models

- You can still use Connect Copy even if no optional large capacity tray (LCT) is available. However, the optional finisher must be installed in both units in order to use Staple functions, and the punch kit must be installed in both units in order to use the Punch function.

Functions Not Available with Connect Copy

The following functions are not available in Connect Copy mode:

- Job Preset

Interrupt Functions

- You cannot use Connect Copy when a job has been paused using the Interrupt function.
- You can use the Interrupt function on the sub-unit while in Connect Copy mode, but only when the master unit is not scanning originals.
- You cannot use other functions in Connect Copy mode no matter how the “Output Priority” of the User Tools (System Settings) is programmed.
- You cannot switch to other functions while in Connect Copy mode. To access other functions you must exit Connect Copy mode.
- While you use other functions, you cannot use Connect Copy mode.

Before You Start

Both machines must have paper trays loaded with paper of the same size, direction and type that you wish to copy onto.

To make the most out of the Connect Copy feature, we recommend that :

- The paper tray settings of the master unit and sub-unit should match each other.
- The “Original Mode Level” of the User Tools (Copier/Document Server Features) settings should be the same on each unit. If they are not the same, the copied images may differ. See ⇒ P.314 “Original Mode Level”
- The User Stamp settings should be the same on each unit. If they are not the same, the copied images may differ. See “Program/Delete Stamp” .⇒ P.174 “Program/Delete User Stamp”

Connect Copy Display Panel

This section describes the displays on the master unit and sub-unit.

Note that when you enter Connect Copy mode, you must access all Connect Copy features and menus through the master unit display panel.

	Master unit	Sub-unit
Initial display in standard copy mode		
Initial display in Connect Copy mode		

4

4

	Master unit	Sub-unit
Display when scanning originals on the master unit		
Display when copying/Interrupt copying		
Number of originals	How many original pages have been scanned by the master unit so far.	Not displayed on sub-unit.

	Master unit	Sub-unit
Copy quantity	How many sets/copies to make.	Not displayed on sub-unit.
Copy counter	Displays how many sets/copies made by the master unit so far.	Displays how many sets/copies made by the sub-unit so far.
Copy paper select	<p>Only paper trays loaded with the paper of the same size, direction and type installed in both the master unit and sub-unit are displayed.</p> <p>Other paper tray types will be grayed out and you cannot select them.</p>	<p>Only paper trays loaded with the paper of the same size, direction and type installed in both the master unit and sub-unit are available.</p> <p>Note that you can only select the copy paper from the master unit operation panel.</p>

Using Connect Copy

You can select Connect Copy mode from either of the two connected machines by pressing the **[Connect]** key. The machine you use becomes the master unit, and the other machine the sub-unit.

⚠ Limitation

- Once Connect Copy is selected, you must carry out all operations on the master unit.

1 Make sure the machine is in copy mode.

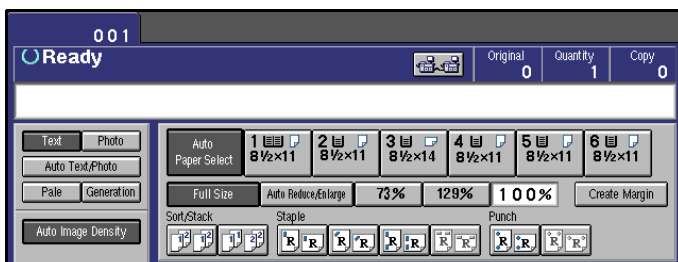

📌 Note

- If user codes are turned on, enter a user code programmed in the master unit with the number keys (up to 8 digits) then press the **[#]** key. You don't need to enter the user code for the sub-unit.

🔍 Reference

See ⇒ P.70 "User Codes".

2 Press the **[Connect]** key on the machine that is to be the master unit.

When the key darkens, the two machines are connected.

❖ Master unit display

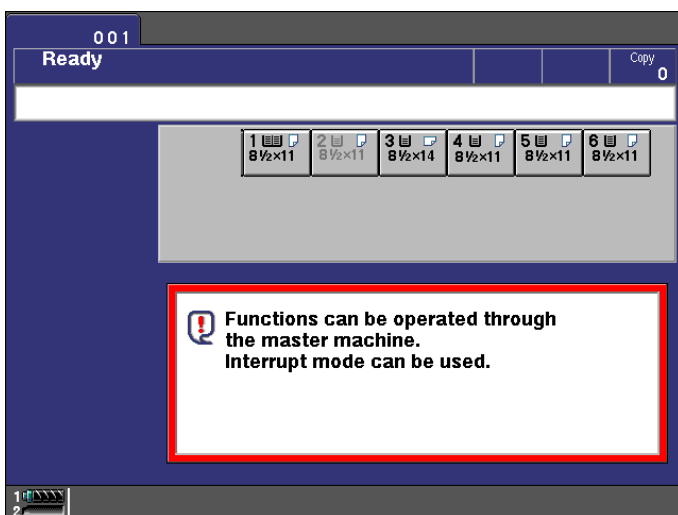

❖ Sub-unit display

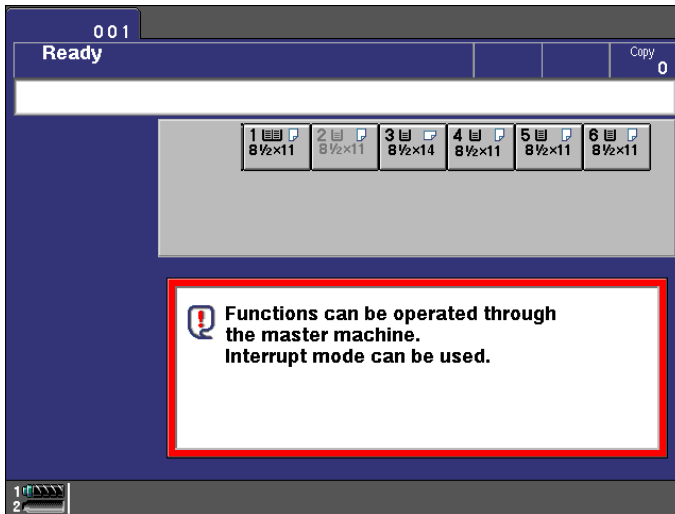

4

🔍 Reference

If the **[Connect]** key is not visible or you cannot select it, see ⇒ P.265 “Connect Copy”.

If you press the **[Connect]** key and see the message and press the **[Cancel]** key. See ⇒ P.269 “If You Cannot Exit Connect Copy”.

3 Set your originals in the master unit.

Originals	Set in the document feeder	Set on the exposure glass
		set1EE
		set2EE

🔍 Reference

See ⇒ P.26 “Setting Originals”.

4 Make any settings you require on the master unit.

Note

- Any copy settings that were set up before you entered Connect Copy mode will still remain in effect. The Punch function requires the optional Punch kit to be installed on both the master and sub-unit.
- To exit Connect Copy mode, press the **[Connect]** key on the master unit again.

5 Enter the number of copies you require with the number keys.

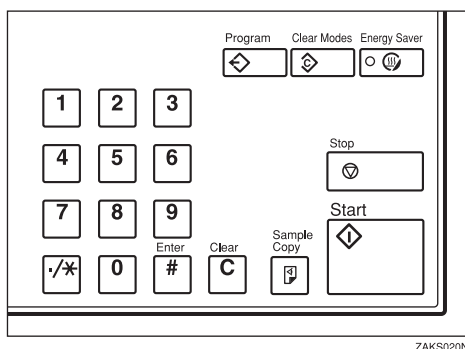

Note

- You can enter up to 9999 copies.
- If you make a mistake, press the **[Clear]** key and enter a new number.
- Even though Connect Copy is selected, only the master unit will make copies in the following situations :
 - When making a single copy set.
 - When the original is a single sheet and you enter a low number of copies/sets.

6 Press the **[Start]** key on the master unit.

Copying starts after the original has been scanned.

Note

- If you have set your originals in the document feeder (ARDF), copying starts simultaneously in the master unit and sub-unit after all originals have been scanned.
- When using the Batch /SADF mode, set your originals and press the **[Start]** key. After all the previously set originals are scanned in, set the next originals while the Auto Feed indicator is lit. When all pages have been scanned in, press the **[#]** key. Copying starts simultaneously in the master unit and sub-unit. See "Batch SADF mode". ⇒ P.32 "Batch/SADF Mode"

- ❑ When scanning from the exposure glass, set the next page(s) when scanning has finished, then press the **[Start]** key. When all pages have been scanned in, press the **[#]** key. Copying starts simultaneously in the master unit and sub-unit.
- ❑ To stop originals being scanned or copied, press the **[Stop]** key on the master unit and follow the instructions on the display, press the **[Yes]** key.

7 Pick up your copies from the master unit and sub-unit.

Note

- ❑ The number of copy sets made by the master unit and sub-unit may differ.
- ❑ The master unit and sub-unit may not finish copying exactly at the same time.
- ❑ When using the Sort/Staple function, copies are organized into copy sets. If there is a paper misfeed in one machine during this process, it is not possible for the other machine to take over the copy set processing of the non functional machine.
- ❑ When using Document Server functions, only the master unit will make copies by the combination of the features.

Copy output order

❖ **When copying in Sort/Staple mode**

e.g., copying 6-sets of a 3-sheet original

- Copying with the master unit (face-down output)—sub-unit (face-down output)

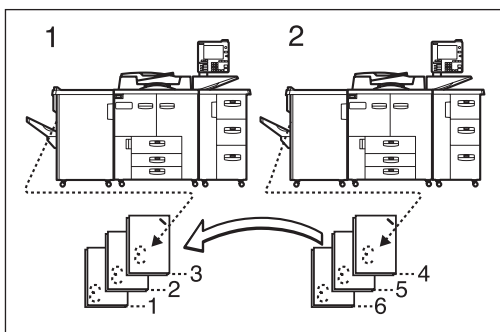

1. Master unit

2. Sub-unit

When using Sort/Staple, your copies sets are not split between the master unit and sub-unit.

❖ **When copying not in Sort/Staple mode**

e.g., making 2 copies of each page of a 6-sheet original

- Copying with the master unit (face-down output)—sub-unit (face-up output)

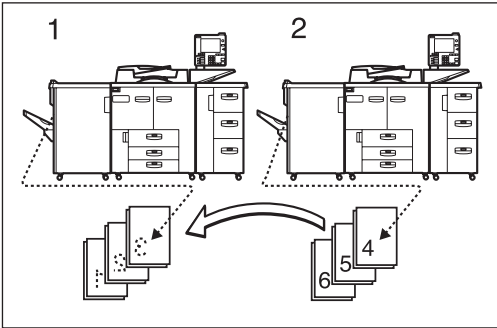

1. Master unit

2. Sub-unit

Combine your copy stacks from the master unit and sub-unit as shown in the diagram.

 **Auto Reset**

The machine exits Connect Copy mode and automatically returns to the initial condition a certain period of time after your job has finished. This function is called “Auto Reset”.

 **Note**

- ❑ After the time that is set in “Copy Reset Timer” on the master unit have passed, the master unit exits Connect Copy mode.
- ❑ While the sub-unit is using Interrupt Copy functions, the Interrupt Copying function is released after the time that is set “System Reset” in the sub-unit.

 **Reference**

See “Copy Reset Timer” in the copy User Tools ⇒ P.312 “General Features”
See “System Reset” in the System Settings manual.

💡 Auto Off

The machine turns itself off automatically a certain period of time after your job has finished. This function is called “Auto Off”.

📌 Note

- ❑ The Auto Off function is available only for the main unit.

🔍 Reference

See “Auto Off Timer” in the System Settings manual.

Exiting Connect Copy Mode

4

- 1 Press the **[Connect]** key on the master unit.

The **[Connect]** key will be deselected.

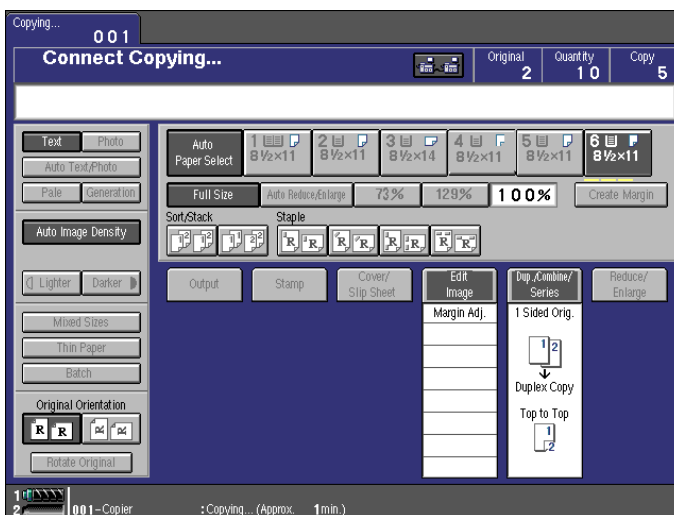

📌 Note

- ❑ Settings which were selected on the master unit while in Connect Copy mode will not be cleared.
- ❑ Press the **[Clear Modes]** key to cancel the master unit settings and return to the initial state.
- ❑ The sub-unit will return to the state which is before entering Connect Copy mode.

🔍 Reference

If you cannot exit Connect Copy mode, see ⇒ P.269 “If You Cannot Exit Connect Copy”

Relationship between Master Unit and Sub-unit System Settings

This section describes which System Settings are used by the master unit and sub-unit in Connect Copy mode.

Note

- In Connect Copy mode the **[User Tools]** key on the sub-unit is disabled. To access the user tools on the sub-unit, you need to exit Connect Copy mode first.

Reference

See System Settings manual for details.

4

Symbol	Meaning
☆	The master unit and sub-unit use each setting
←	Both units use the master unit setting
—	Unrelated
★	Depends on the function

Menu	Master unit	Sub-unit	Remarks
General			
Function Priority	—	—	When the time set in the “Copy Reset Timer” of the user tools (Copier/Document Server Features) on the master unit passed and the Connect Copy is canceled, and then the time set in the “System Reset” of the user tools (System Setting) passed, it returns to the function defined by the “Function Priority” of the User Tools (System Settings) setting.
Panel Tone	☆	☆	
Ready Panel Tone	☆	☆	
Copy Count Display	—	—	The copy counter is always displayed in count up mode.
System Reset	—	★	Interrupt mode on the sub-unit will be cleared by this timer.

Menu	Master unit	Sub-unit	Remarks
Function Reset Timer	—	—	Other function will begin after the connect copy mode is canceled.
Energy Saver Timer	—	—	Energy Saver modes. When Connect Copy is exited, the machine will enter Energy Saver mode after certain period of time passed.
Panel Off Timer	—	—	
Auto Off Timer	☆	—	Sub-unit will not be in Auto Off mode during Connect Copying.
Auto Tray Switching	☆	☆	
Copier/Document Server Output Tray	☆	☆	
Printer Output Tray	☆	☆	
Print Priority	—	—	Other function will begin after the connect copy mode is canceled.
Interleave Print Pages	—	—	
Status Indicator	☆	☆	
Language Priority	☆	☆	
Screen Color Setting	☆	☆	
Original: F/F4 Size Setting	☆	—	
Paper Tray Priority	☆	☆	
Timer Settings			
Date	☆	☆	The date setting depends on the master unit.
Time	☆	☆	
Weekly Timers: Monday to Sunday	☆	—	This function is not available on the sub-unit in Connect Copy mode. When Connect Copy is exited, the power will be switched off at the time specified by the timer.
Key Operator Code for Off Setting	—	—	

Menu	Master unit	Sub-unit	Remarks
Tray Paper Settings			
Tray1: Paper Type	☆	☆	We recommend that the master unit and sub-unit have the same paper tray settings. This is because only paper trays with the same size, direction, and type of paper can be used in Connect Copy mode.
Tray2: Paper Type	☆	☆	
Tray3: Paper Type	☆	☆	
Tray4: Paper Type	☆	☆	
Tray5: Paper Type	☆	☆	
Tray6: Paper Type	☆	☆	
Slip Sheet 1	☆	☆	
Slip Sheet 2	☆	☆	
Slip Sheet 3	☆	☆	
Cover Sheet	☆	☆	
Separation Sheet	☆	☆	
Key Operator Tools			
User Codes: Copier/Document Server	☆	—	Access these settings on the master unit. The master unit settings override those of the sub-unit.
Key Counter: Copier Access	—	—	
Key Counter: Printer Access	—	—	
Key Card: Copier Access	☆	—	
Key Card: Printer Access	☆	—	
Memory Allocation	☆	☆	Memory Allocation for the copy function set in each unit will be used for Connect Copy mode.
Key Operator Access	★	★	
AOF (Keep It On.)	—	—	Function in Connect Copy mode. The power will go off after you have exited Connect Copy mode and the AOF Delay has elapsed.
Check/Reset/Printer Copy Counter	—	—	

Relationship between Master Unit and Sub-Unit Copier/Document Server Features

This section describes which Copier Feature settings are used by the master unit and sub-unit in Connect Copy mode.

Note

- In Connect Copy mode the **[User Tools]** key on the sub-unit is disabled. To access to the User Tools on the sub-unit, you need to exit Connect Copy mode first.

Reference

See ⇒ P.312 “Settings You Can Change with the User Tools”.

4

Symbol	Meaning
☆	The master unit and sub-unit use each setting
←	Both units use the master unit setting
—	Unrelated

Menu	Master unit	Sub-unit	Remarks
General Features			
Auto Paper Select Priority	☆	—	Trays with the same size and direction of paper will be selected from the master unit and sub-unit automatically.
Auto Image Density Select Priority	☆	—	
Original Mode Priority	☆	—	
Duplex Mode Priority	☆	—	
Copy Orientation in Duplex Mode	☆	—	
Original Orientation In Duplex Mode	☆	—	
Initial Mode Set	☆	—	
Maximum Copy Quantity	☆	—	
Copy Reset Timer	☆	—	Connect Copy will be cancelled according to the timer on the master.

Menu	Master unit	Sub-unit	Remarks
Job List Screen Timeout	☆	—	
Paper Eject: Always Rotate 180°	☆	←	
Manual Original Counter Reset	☆	—	
Set Ratio			
Preset Reduce/Enlarge	☆	—	
Preset Reduce/Enlarge Priority	☆	—	
Shortcut R/E	☆	—	
Create Margin Ratio	☆	—	
Original Mode Level			
Image: Text	☆	☆	
Image: Auto Text/Photo	☆	☆	
Image: Photo	☆	☆	
Image:Pale	☆	☆	
Image: Generation	☆	☆	
Display/Panel Tone			
Original Mode Display	☆	☆	
Special Original Display	☆	—	
Paper Type Display	☆	—	This function is available only for the main unit. The sub-unit display the type of paper whether this function is selected or not.
Panel Features Default	☆	—	
Image Adjustment Priority	☆	—	
Staple Position	☆	—	
Original Tone	☆	—	
Job End Call	☆	☆	When turned on, the tone sounds only on the master unit when copying is completed. Only if the "Panel Tone" of the User Tools (System Settings) is on.

Menu	Master unit	Sub-unit	Remarks
Adjust Image			
Copy Back Cover	☆	←	
Front Margin: Left/Right	☆	←	
Back Margin: Left/Right	☆	←	
Front Margin: Top/Bottom	☆	←	
Back Margin: Top/Bottom	☆	←	
1 → 2 Duplex Auto Margin Adjust	☆	←	
Border Erase Width	☆	←	
Combine Orig. Shadow Erase	☆	←	
Center Erase Width	☆	←	
Repeat Separation Line	☆	←	
Double Copies Separation Line	☆	←	
Combine Separation Line	☆	←	
Copy Order In Combine Mode	☆	←	
Copy Orientation In Booklet/Magazine	☆	←	
Front Cover Copy In Combine Mode	☆	←	
Designated Slip Sheet Copy In Combine Mode	☆	←	
Stamp			
Background Numbering			
Size	☆	←	
Density	☆	←	
Superimpose	☆	←	
Preset Stamp			
Stamp Language	☆	←	The master unit setting will be applied. However, set the same settings in both
Stamp Priority	☆	←	
Stamp Format	☆	←	

Menu	Master unit	Sub-unit	Remarks
Superimpose	☆	←	
User Stamp			
Program/Delete Stamp	☆	←	Set the same stamp in the both unit.
Stamp Format	☆	←	
Date Stamp			
Format	☆	←	
Font	☆	←	
Position Priority	☆	←	
Size	☆	←	
Superimpose	☆	←	
Page Numbering			
Format	☆	←	
Font	☆	←	
Position Priority	☆	←	
Size	☆	←	
Duplex Back Page Number Position	☆	←	
Page Numbering In Combine Mode	☆	←	
Copy On Slip Sheet In Designate Mode	☆	←	
Superimpose	☆	←	
Position Priority: P1, P2	☆	←	
Position Priority: 1/5, 2/5	☆	←	
Position Priority: -1-, -2-	☆	←	
Position Priority: P.1, P.2	☆	←	
Position Priority: 1,2	☆	←	
Position Priority: 1-1, 1-2	☆	←	
Input/Output			
SADF Auto Reset Timer	☆	—	
ADF Original Table Rise Time	☆	—	

Menu	Master unit	Sub-unit	Remarks
Face-up/down Eject From Platen	☆	—	The setting will be ignored and the setting programmed for Connect Copy will be used.
Auto Sort Mode	☆	—	
Memory Full Auto Scan Restart	☆	←	
Shift Tray	☆	—	
Separation Sheet	☆	←	
Document Server			
File List Sort Priority	—	—	
Store Mode Priority	☆	—	
Auto File Delete	☆	☆	
Delete All The Saved Files	—	—	
Delete All The Saved Files In CD	—	—	
CD Read/Write Speed Control	—	—	
Key Operator Tools			
Check/Reset/Print Copy Counter	—	—	
Program/Change/Delete User Code	—	—	
Connect Copy Master	—	—	

5. What to do if Something Goes Wrong

If Your Machine Does Not Operate as You Want

General

Machine Status	Problem/Cause	Action
The machine instructs you to wait.	The machine is warming up.	Wait for the machine to warm-up. 🔍 Reference You can use Auto Start mode during warm-up. See ⇒ P.70 "Auto Start".
	Copy paper is moving in tray 1 (Tandem Tray).	Please wait until paper has moved.
The machine cannot detect the original size.	Improper original is set. See ⇒ P.16 "Sizes Difficult to Detect".	Set non-standard size originals on the exposure glass.
		Input the both horizontal and vertical sizes of the non-standard original. See ⇒ P.26 "Setting Originals on the Exposure Glass".
		Select paper manually. Do not use Auto Paper Select.
	Do not use Auto Reduce/Enlarge.	
	Original is not set.	Set your originals.
The machine instructs you to check the original direction.	There is no copy paper that is the same direction as the originals.	Set the original in the same direction as the copy paper.
The machine instructs you to check the paper size.	Improper original size is set.	Select the proper paper size.
Staple mode has been reset.	The paper size was changed during stapling.	You can only staple together pages of the same size. Select copy paper of the same size.





Machine Status	Problem/Cause	Action
The number of sheets that can be stapled has been exceeded.	--	Check the stapler capacity. See ⇒ P.49 "Staple".
The machine cannot staple this size paper.	--	Select a paper size that can be used in Staple mode. See ⇒ P.49 "Staple"
This paper is not available in Duplex mode.	A paper size not available in Duplex mode has been selected.	Select a paper size that can be used in Duplex mode. See ⇒ P.84 "Duplex"
You cannot enter the desired copy set number.	The number of copies exceeds the maximum copy quantity.	You can change the maximum copy quantity. See "Maximum Copy Quantity" ⇒ P.312 "General Features".



5

Document Server

Problem	Action
"Exceeded max. disk memory (50 files)." is displayed.	The maximum number of files you can store is 250 in the HDD, 50 files in the CD-RW (option). Delete any unnecessary files and then scan the document again.
"Insufficient memory. The selected file cannot be transmitted." is displayed.	Delete any unnecessary files and then scan the document again. See ⇒ P.330 "Document Server"
	Change the Memory Allocation. See "Memory Allocation" in the System Settings manual. However if you change this setting, the documents in the HDD will be deleted. Print the stored documents in the HDD.
"The selected file(s) currently in use." is displayed.	Change the disk in the CD-RW. The disk must be unformatted one that has already been used in this machine.
"Cannot recognize" is displayed.	Make sure the selected file is not using in document server or document editor function.

Connect Copy

Machine Status	Cause	Action
You cannot use Connect Copy.	The sub-unit has a paper misfeed or needs a fresh supply of toner or other replenishable supply.	<p>Press the [Cancel], key on the master unit and follow the instructions given on the sub-unit display.</p> <p> Reference</p> <p>See ⇒ P.283 “ Changing the Toner Bottle”</p> <p>See ⇒ P.286 “ Clearing Misfeeds”</p> <p>See ⇒ P.302 “ Removing Jammed Staples”</p> <p>If the sub-unit display shows that a cover is open, follow the instructions given. For all other situations, follow the instructions on the display.</p>
	The User Tools menu is open on the sub-unit.	Press the [Cancel] key on the master unit. Then on the sub-unit press the [User Tools] key to close the User Tools menu.

Machine Status	Cause	Action
<p>You cannot use Connect Copy.</p>	<p>The sub-unit is busy copying or printing with another function.</p>	<p>Press the [Cancel] key on the master unit then stop the sub-unit from copying/printing.</p>
	<p>The sub-unit is in Interrupt mode.</p>	<p>Press the [Cancel] key on the master unit. Then press the [Interrupt] key on the sub-unit to exit Interrupt mode.</p> <p> Reference See ⇒ P.68 “Interrupt Copy”</p>
	<p>The sub-unit has been switched off automatically by the Weekly Timer function and is waiting for the Key Operator Off Code to be entered.</p>	<p>Press the [Cancel] key on the master unit. Then on the sub-unit enter the code and press the [#] key.</p> <p> Reference See “Key Operator Code For Off Setting” in the System Settings manual</p>
	<p>The sub-unit is not in Copy mode (i.e., Document Server mode).</p>	<p>Press the [Cancel] key on the master unit. Then press the [Copy] key on the sub-unit to switch over to copy mode.</p>
	<p>The [Connect] key was pressed simultaneously on both the master unit and sub-unit.</p>	<p>Press the [Cancel] key on both the master unit and sub-unit, then press the [Connect] key on just one of them.</p>
	<p> indicator is lit on the sub-unit.</p>	<p>Follow the instructions shown on the display.</p>
<p>You cannot use Connect Copy. The other machine is in use.</p>	<p>The master unit is not in Copy mode (i.e. Document Server mode).</p>	<p>Press the [Cancel] key on the master unit. Then press the [Copy] key on the master unit to switch over to the copy function.</p>



Display

Problem	Cause	Action
The display panel is off.	The screen contrast is set too dark.	Turn the screen contrast knob to adjust the contrast.
	The machine is in Energy Saver mode.	Press the [Energy Saver] key to exit Energy Saver mode.
	The operation switch is turned off.	Turn on the operation switch.
Nothing happens when the operation switch is turned on.	The main power switch is turned off.	Turn on the main power switch. See ⇒ P.4 "Guide to Components"
	The circuit breaker has cut out.	Call your service representative.

5

Connect Copy

Machine Status	Cause	Action
The [Connect] key does not appear on the display.	The main power switch on the sub-unit is off.	Turn on the sub-unit main power switch.
	The operation switch on the sub-unit is off.	Press the operation switch on the right side of the operation panel. The On indicator will light.  Note <input type="checkbox"/> The machine will be ready to operate about five minutes after turning power on.
	The master unit is not in Copy mode.	Press the [Copy] key on the master unit to switch to the copy function.
	The master unit is in Interrupt mode.	Press the [Interrupt] key on the master unit to exit Interrupt mode.



Machine Status	Cause	Action
The [Connect] key does not appear on the display.	The master unit is in Preset Jobs mode.	Exit Preset Jobs mode in one of the following ways. <ul style="list-style-type: none"> ❖ If you are still selecting copy settings and copying has not started yet : Press the [Clear] key then remove the originals set in the master unit document feeder. ❖ If Preset Jobs mode is in progress : Press the [Stop] key, follow the instructions on the display then press the [Cancel] key. <p> Reference See "Preset Jobs" ⇒ P.60 "Job Preset"</p>
The [Connect] key does not appear on the display.	The "Connect Copy" of User Tools setting is set to "No".	Change the setting to "Yes" or press the [Connect] key on the other unit. <p> Reference See "Connect Copy" ⇒ P.265 "Connect Copy"</p>
	The Connect Copy cable is damaged.	Please contact your service representative.
	! indicator is lit.	Follow the instructions shown on the display.

Machine Status	Cause	Action
The [Connect] key is grayed out.	The master unit is now copying or copying will start as soon as the warm-up finished.	Press the master unit [Stop] key to cancel copying.
	Copying has stopped because there is a paper misfeed or toner has run out on the unit you wish to use as the master unit.	Solve the problem on the master unit.
	Functions are programmed that cannot be used with Connect Copy.	Press the master unit [Clear Modes] key to clear the programmed functions.



Document Server





Problem	Cause	Action
Nothing displayed when you press the [Delete From CD-ROM] key.	The power of the CD-RW is not turned on.	Press the power switch on the CD-RW.
	The disk in the CD-RW is not a recommended one.	Change the disk in the CD-RW. The disk must be unformatted one that has already been used in this machine.
The password dialog is displayed when you select the document.	This document has been assigned a password.	<p>You cannot edit documents unless you know the password.</p> <p> Note</p> <p><input type="checkbox"/> To delete all HDD files, see ⇒ P.330 "Document Server"</p>

If Connect Copy is Cleared

Machine Status	Cause	Action
Exited Connect Copy.	The master unit main power switch has been turned off or the operation switch has been pressed.	On the master unit, either turn on the main power switch or press the operation switch, then press the [Connect] key and start your copy job again.
	Either the sub-unit main power switch has been turned off or the operation switch has been pressed.	A message requesting you to check the sub-unit is displayed on the master unit. Press the [Cancel] key to clear connect-copying. Either turn on the main power switch on the sub-unit or press the operation switch. Then press the [Connect] key.
	The Weekly Timer function has automatically turned the master unit off.	Press the master unit operation switch. Then press the [Connect] key and copy.  Reference See "Weekly Timer" in the System Settings manual.
An error message indicating a breakdown is shown on the master unit display.	 indicator is lit.	Follow the instructions displayed in the error message. Copying is not possible.

If You Cannot Exit Connect Copy

Machine Status	Cause	Action
Nothing happens when you press the [Connect] key.	Originals are being scanned or copied.	Press the master unit [Stop] key and then press [Yes] key to cancel scanning or copying.
	There is a paper misfeed in either the master unit or sub-unit.	<p>Clear the paper jam in the master unit or sub-unit.</p> <p> Reference See ⇒ P.286 “ Clearing Misfeeds” See ⇒ P.302 “ Removing Jammed Staples”</p> <p>If the “Cover Open” display appears, follow the instructions given.</p> <p>For any other problems, follow the instructions that are displayed.</p> <p>To exit Connect Copy mode, press the master unit [Stop] key, then press the [Connect] key.</p>
	The master unit [Stop] key was pressed and scanning of the original has been interrupted.	To exit Connect Copy mode, follow the instructions on the display, then press the [Cancel] key.
	The [Stop] key was pressed on either the master unit or sub-unit and copying has been interrupted.	To exit Connect Copy mode, follow the instructions on the display, then press the [Cancel] key.

Machine Status	Cause	Action
Nothing happens when you press the [Connect] key.	The master unit or sub-unit needs a fresh supply of toner or staples.	<p>Solve the problem in the appropriate unit.</p> <p> Reference</p> <p>See ⇒ P.277 “ Loading Paper”</p> <p>See ⇒ P.283 “ Changing the Toner Bottle”</p> <p>See ⇒ P.299 “ Adding Staples”</p> <p>See ⇒ P.305 “ Removing Punch Waste”</p> <p>For any other problems, follow the instructions that are displayed.</p> <p>To exit Connect Copy mode, press the master unit [Stop] key. then press the [Cancel] key.</p>
	A paper misfeed occurred during stapling.	<p>Remove the misfed paper.</p> <p>To exit Connect Copy mode, press the [Stop] key, then press the [Connect] key.</p>

If You Cannot Make Clear Copies

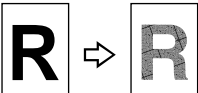
Problem	Cause	Action
Copies appear dirty.	The image density is too dark.	Adjust the image density ⇒ P.34 "Adjusting Copy Image Density".
	Auto Image Density is not selected.	Select Auto Image Density.
The reverse side of an original image is copied.	The image density is too dark.	Adjust the image density ⇒ P.34 "Adjusting Copy Image Density".
	Auto Image Density is not selected.	Select Auto Image Density.
A shadow appears on copies when copying pasted originals.	The image density is too dark.	Adjust the image density ⇒ P.34 "Adjusting Copy Image Density".
		Set the original in a different direction.
		Fix mending tape to the pasted part.
The same copy area is dirty whenever making copies.	The exposure glass or document feeder belt is dirty.	Clean them ⇒ P.337 "Maintaining Your Machine".
Copies are too light.	The image density is too light.	Adjust the image density ⇒ P.34 "Adjusting Copy Image Density".
	Damp or rough grain copy paper is being used.	Use dry paper without a rough grain.
	Toner cartridge is almost empty.	Add toner ⇒ P.283 "Changing the Toner Bottle".
Parts of the image are not copied.	The original is not set correctly.	Set originals correctly ⇒ P.26 "Setting Originals".
	An improper paper size is selected.	Select the proper paper size.
Copies are blank.	The original is not set correctly.	Set originals correctly ⇒ P.26 "Setting Originals".
A moiré pattern is produced on copies. 	Your original has a dot pattern image or many lines.	Place the original on the exposure glass at a slight angle.

If You Cannot Make Copies As You Want

5

Problem	Cause	Action
Copies are not stapled.	There are jammed staples in the stapler.	Remove jammed staples. See ⇒ P.302 “  Removing Jammed Staples”.
	The number of copies exceeds the capacity of the stapler.	Check the stapler capacity. See ⇒ P.49 “Staple”.
Staples are wrongly positioned.	Originals are not set correctly.	Set originals correctly. See ⇒ P.49 “Staple”.
Misfeeds occur frequently.	The copy paper size setting is not correct.	Set the proper paper size. See ⇒ P.294 “Changing the Paper Size”.
		Make sure the back fence in the paper tray is set correctly.
You cannot combine several functions.	Selected functions cannot be used together.	Refer to the combination chart. See ⇒ P.193 “Combination Chart”.
When sorting the pages are divided into two blocks.	Memory ran out during sorting and the pages were ejected in two blocks.	You can interrupt copying when memory runs out. See “Memory Full Auto Scan Restart” ⇒ P.328 “Input/Output”.

Adjust Image

Problem	Cause	Action
In Double Copies mode, parts of the original image are not copied.	The original and copy paper do not match.	Select the proper original and copy paper. See ⇒ P.143 “Double Copies”.

Problem	Cause	Action
In Centre/Border mode, parts of the original image are not copied.	You set too wide an erased margin.	Make the margin narrower with the User Tools. See "Border Erase Width" and "Centre Erase Width" ⇒ P.318 "Adjust Image".
	Your original has narrow margins on four sides.	
In Margin Adjustment mode, parts of the original image are not copied.	You set too wide an erased margin.	Set a narrower margin with the User Tools. See "Front Margin: Left/Right" and "Back Margin: Left/Right" ⇒ P.318 "Adjust Image".
In Image Repeat mode, the original image is not copied repeatedly.	You selected the same size copy paper as originals, and did not select the proper reproduction ratio.	Select copy paper larger than the originals.
		Select the proper reproduction ratio.

Combine

Problem	Cause	Action
You cannot make a book from a booklet or magazine by folding copies.	Combine Original Booklet Format or Combine Original Magazine Format is not correct.	Change the setting ⇒ P.90 "Combine".
Parts of the image are not copied.	You specified an improper reproduction ratio that does not meet the sizes of your originals and copy paper.	When you specify a reproduction ratio using Manual Paper Select mode, make sure the ratio matches your originals and the copy paper.  Note <input type="checkbox"/> Select the correct reproduction ratio before using Combine mode.
	Your originals are not identical in size and direction.	Use originals that are identical in size and direction.

Problem	Cause	Action
Order of copies is not correct.	You set originals in the incorrect order.	When setting a stack of originals in the document feeder, the last page should be on the bottom.
		If you set an original on the exposure glass, start with the first page to be copied.

Duplex

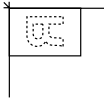
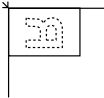
Problem	Cause	Action
Order of copies is not correct.	You set originals in the incorrect order.	When setting a stack of originals in the document feeder, the last page should be on the bottom.
		If you set an original on the exposure glass, start with the first page to be copied.
Orientation of copies (Top to Top, or Top to Bottom) is not correct.	You set originals in an incorrect direction or the orientation setting is incorrect.	<p>Set the original orientation to Select the correct orientation, or set originals correctly ⇒ P.84 "Duplex", P.28 "Original Orientation"</p> <p> Note</p> <p><input type="checkbox"/> If you set A3, 11" × 17" or B4, 8¹/₂" × 14" originals as shown below, select [Top to Bottom] to make copies with "Top to Top" orientation. Alternatively select [Top to Top] to make copies with "Top to Bottom" orientation.</p> <div style="display: flex; justify-content: space-around; align-items: center;">   </div> <p style="text-align: right; font-size: small;">CP270-A</p>

Stamp

Problem	Cause	Action
The wrong date is printed.	The machine main power has been turned off for more than 20 days.	Set the date correctly again. See "Date Settings" in the "System Settings".
The stamp position is wrong.	The paper orientation is wrong.	Check the paper orientation and stamp position.
The stamp does not appear.	Stamp is too large to print.	Check the size of the user stamp and register it again. See ⇒ P.174 "Program/Delete User Stamp"

Document Server

Problem	Cause	Action
You want to find out what is stored in a file.	--	Check the date/time column in the File List.
		Print the first page of the documents. See ⇒ P.210 "Print First Page"
Memory is full.	The Document Server Memory is full.	Delete any unnecessary files and then scan the document again. See ⇒ P.330 "Document Server"
		Change the Memory Allocation. See "Memory Allocation" in the System Settings manual. However if you change this setting, the documents in the HDD will be deleted. Print the stored documents in the HDD.
You cannot store documents.	The Document Server is full.	The maximum number of files you can store is 250 in the HDD, 50 files in the CD-RW (option). Delete any unnecessary files and then scan the document again.

Connect Copy

Machine Status	Cause	Action
You can not use the Punch function.	The sub-unit does not have the optional punch kit.	Press the [Connect Copy] key to disconnect, then start copying.
The copied images differ.	The "Original Mode" of the user tools (Copy Features) settings are not the same.	See ⇒ P.318 " <i>Adjust Image</i> "
	The user stamp settings are not the same on the master unit and sub-unit.	Register the same stamp in each user stamp.

When Memory is Full

5

If the number of originals exceeds a certain limit, the machine will run out of memory, for Connect Copy scans in all your originals into memory.

Limitation

- If memory is full on either the master unit or sub-unit, Interrupt will not be available.

Note

- If you set the "Memory Full Auto Scan Restart" setting in the User Tools (Copier/Document Server Features) to "Yes", the memory overflow message will not be displayed, but originals scanned so far will be copied automatically. Connect Copy continues scanning and copying until finishing the job. Please note that copy sets will be printed out separated by scanning at this time.

Machine Status	Action
The memory is full.	Press the [Output] key to copy scanned originals and clear the scanning data. Press the [Clear] key to clear the scanning data and not copy.
The machine asks you whether you want to scan the remaining originals.	To continue copying, remove all copies then press the [Resume] key. To stop copying, press the [Cancel] key.

Loading Paper

Note

- For how to change the paper size of tray 2 (500-sheet tray), see ⇒ P.294 “Changing the Paper Size”.

Reference

For information on paper types and sizes, see ⇒ P.18 “Copy Paper”.

To load paper in tray 1 (Tandem Tray)

Important

- When the paper on the right side in tray 1 runs out, the paper on the left side will automatically move to the right side. While the paper on the left side is moving, the machine instructs you to wait. At this time, do not pull out the tray.

Note

- You can load paper even while you are copying onto paper loaded in Tray 1 by pulling out the left half of the tray.
- Load the same size and direction paper in the other half of the tray.

1 Pull out the paper tray until it stops.

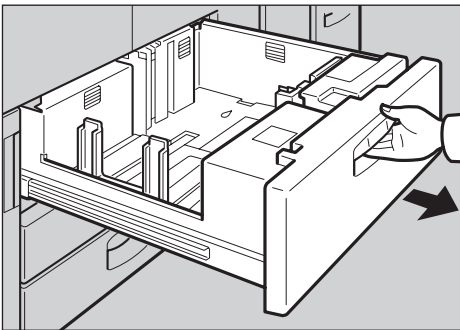

ZAKY010E

2 Square the paper and set it in the tray.

❖ When the whole tray is pulled out:

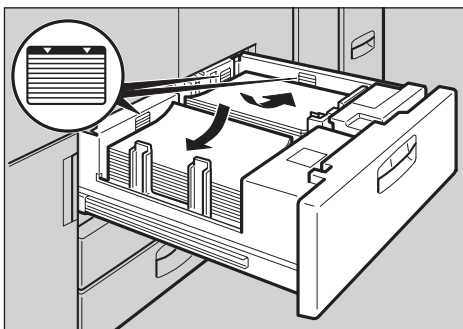

ZAKY020E

Important

❑ Push the right paper to the right side, and the left paper to the left side.

5

❖ When the left half of the tray is pulled out:

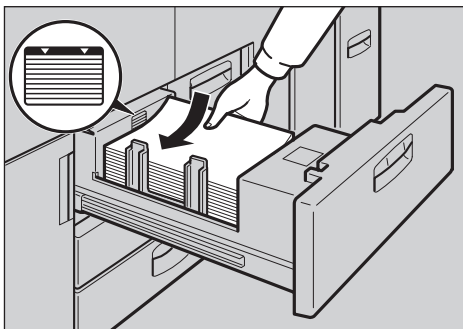

ZAKY030E

Important

❑ Do not stack paper over the limit mark.

❑ Make sure that the paper stack is flush with the left side fence.

Note

❑ Fan the paper before placing it in the tray.

❑ If paper is curled or warped, correct the curl or warp before placing it in the tray.

3 Push the paper tray in until it stops.

Loading paper in Tray 2 or 3

1 Pull out the paper tray until it stops.

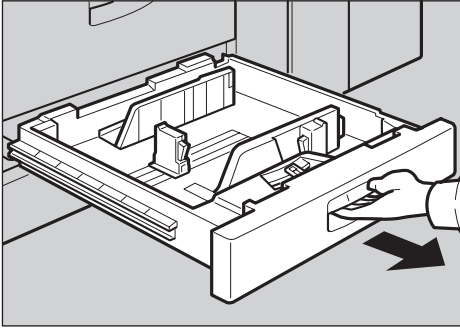

ZAJY040E

2 Square the paper and set it in the tray.

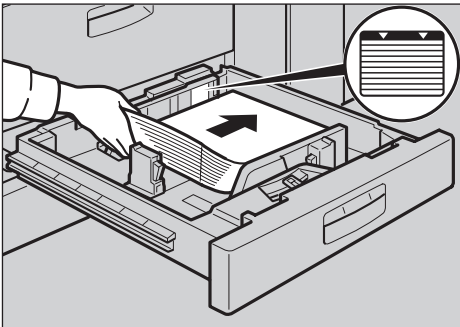

ZAJY050E

5

Important

- Do not stack paper over the limit mark.
- Make sure that the paper stack is flush with the right side fence.

Note

- Fan the paper before placing it in the tray.
- If paper is curled or warped, correct the curl or warp before placing it in the tray.

3 Push the paper tray in until it stops.

Loading Paper in the Large Capacity Tray

1 Pull out the Large Capacity Tray until it stops.

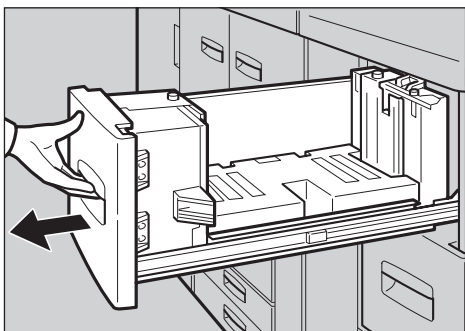

ZAJY090E

2 Place the paper in the tray along the edge on the left.

5

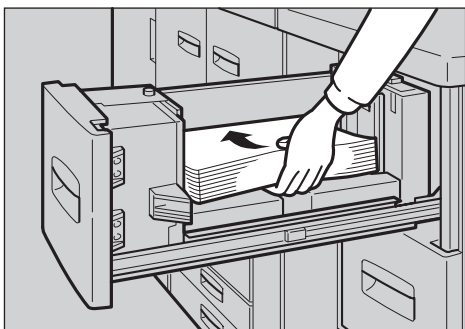

ZAKY090E

Important

Do not stack paper over the limit mark.

Note

Tray 4 and Tray 5 can hold up to 1,000 sheets, and the tray 6 can hold up to 2,550 sheets.

3 Push the Large Capacity Tray in until it stops.

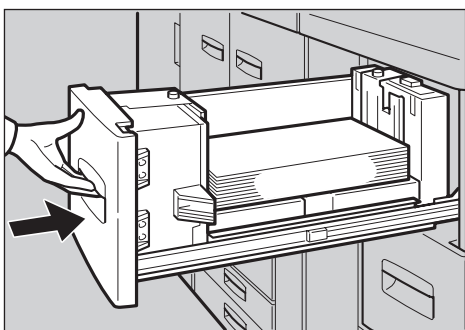

ZAKY100E

Loading Paper in the Optional A3/11" × 17" Tray Kit

- 1** Pull out the A3/11" × 17" Tray until it stops.

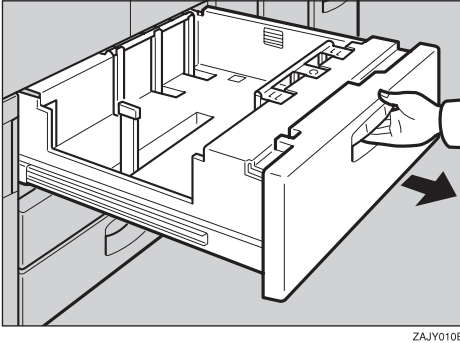

ZAJY010E

- 2** Place the paper in the tray along the edge on the left.

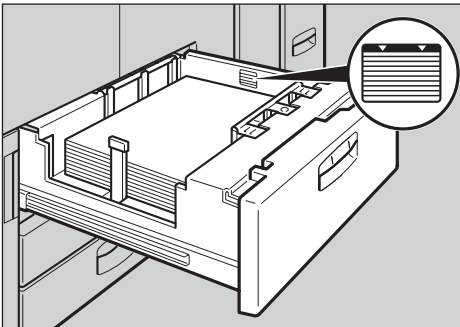

ZAJY020E

Important

- Do not stack paper over limit mark.
- Make sure that the paper stack is flush with the right side fence.

Note

- Fan the paper before placing it in the tray.
- If paper is curled or warped, correct the curl or warp before placing it in the tray.

3 Push the paper tray in until it stops.

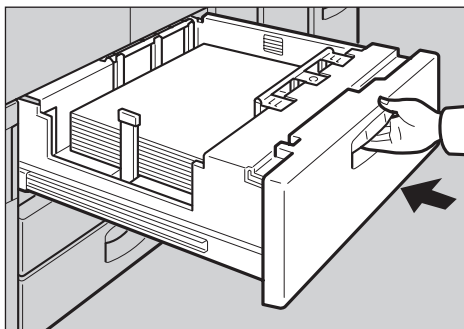

ZAJY520E

5

Changing the Toner Bottle

When  is displayed, it is time to supply toner.

WARNING:

- ***Do not incinerate used toner or toner containers. Toner dust might ignite when exposed to an open flame. Dispose of used toner containers in accordance with local regulations for plastics.***

CAUTION:

- *Keep toner (used or unused) and toner containers out of reach of children.*



CAUTION:

- *Our products are engineered to meet high standards of quality and functionality, and we recommend that you only use the expendable supplies available at an authorized dealer.*

Important

- If you use toner other than that recommended, a fault might occur.
- When changing toner, do not turn off the operation switch or your settings will be cleared.
- Always add toner after the machine instructs you to.
- Do not add used toner. This will damage the machine.
- During the toner adding, the toner bottle is rotating. Do not touch the toner bottle.

Note

- If the both toner bottles are empty,  will appear.
- You can still make about 200 copies after  appears, but replace the toner early to prevent poor copy quality.
- If one of the toner bottle is empty, you can keep copying by using the other bottle.
- You can change the toner bottle during copying.
- If toner remain in the bottle, you cannot pull it out.
- When you change one toner bottle, do not touch the other one.

Reference

For how to store toner, see ⇒ P.21 “Toner Storage”.

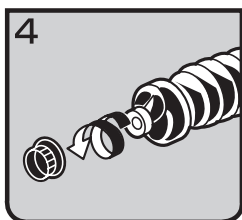
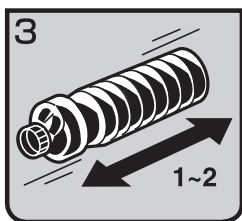
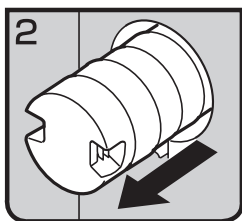
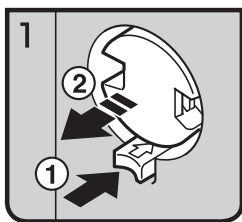

- 1: Open the toner cover.
- 2: Push the green button to release the toner bottle.

- 3: Pull out the toner bottle gently.

- 4: Shake the new toner bottle 1 or 2 times.
- 5: Remove the outer cap.

 **Note**

- Do not remove the inner cap.

- 6: Place the toner bottle in position, then push it in until the green button clicks.

 **Note**

- If you can't get it to click in, pull out the toner bottle a little, slightly rotate it to the left or right, then try again.



- 7: Return the button under the toner bottle to its original position.
- 8: Close the toner cover.

Clearing Misfeeds

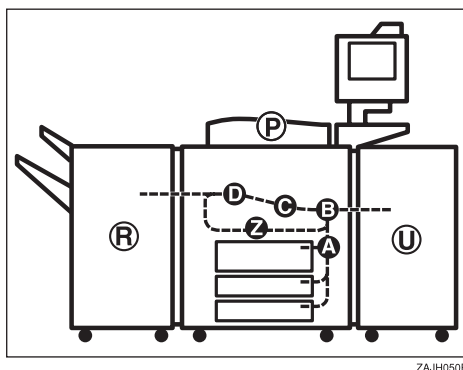

CAUTION:

- *The fusing section of this equipment might be very hot. You should be very careful that you don't touch this section when removing the misfed paper.*

Important

- When clearing misfeeds, do not turn off the operation switch or your copy settings will be cleared.
- To prevent misfeeds, do not leave any torn scraps of paper within the machine.
- If paper misfeeds occur repeatedly, contact your service representative.

Note

- More than one misfeed area may be indicated. In this case, check every applicable area. Refer to the following charts: A, B, C, D, U, P, R (R1 – R6), Z
- You can find a sticker explaining how to remove misfeed paper inside of the front cover or inside of the finisher.

This page is intentionally blank.

When Z is lit

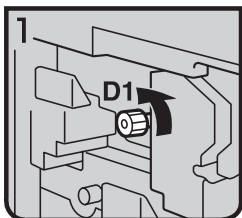

- ① Open the front cover of the machine.
② Turn knob D1 counterclockwise a few times.

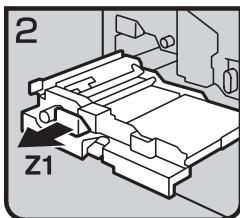

- ③ Pull handle Z1 and fully pull out the duplex unit.

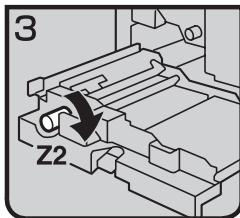

- ④ Turn knob Z2.

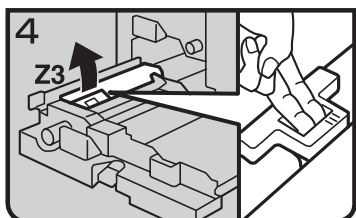

- ⑤ Hold up lever Z3.

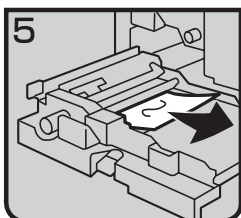

- ⑥ Remove misfed paper.

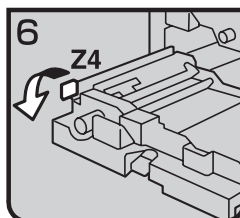

- ⑦ Turn lever Z4.

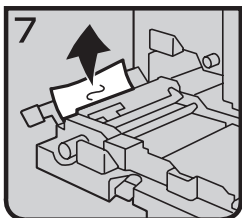

- ⑧ Remove misfed paper.

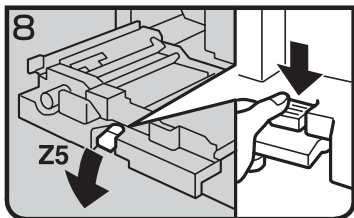

- ⑨ Hold down handle Z5.

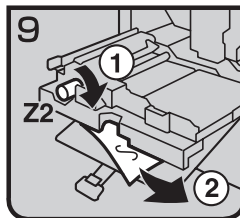

- ⑩ Turn knob Z2 and remove misfed paper.
⑪ Return handle Z5 to its original position.
⑫ Push the duplex unit
⑬ Close the front cover.



When B is lit

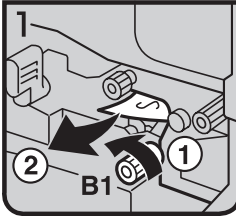

- ① Open the front cover of the machine.
- ② Turn knob B1 and remove misfed paper.

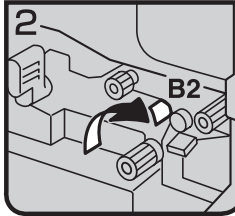

- ③ Hold down lever B2.

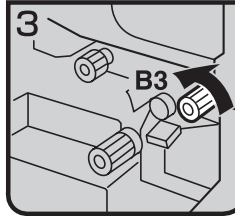

- ④ Turn knob B3.
- ⑤ Return lever B2 to its original position.

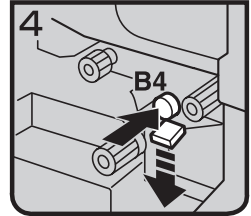

- ⑥ Push button B4 and open the guide plate.

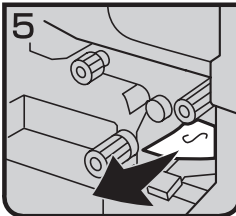

- ⑦ Remove misfed paper.
- ⑧ Close the guide plate.
- ⑨ Close the front cover.

When A is lit

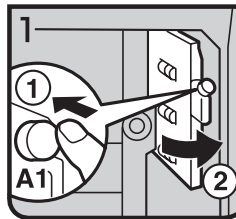

- ① Open the front cover of the machine.
- ② Push button A1 and open the guide plate.

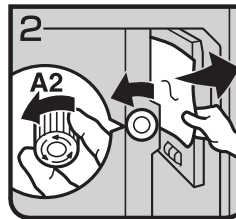

- ③ Turn knob A2 and remove misfed paper.
- ④ Close the guide plate.
- ⑤ Close the front cover.

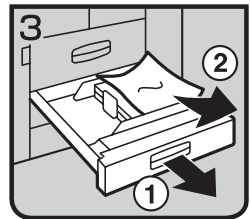

- ⑥ If you can not remove misfed paper, pull the paper tray and remove it.

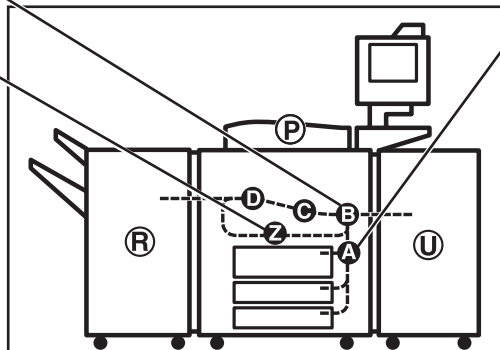

When P is lit

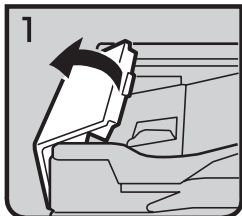

① Open the cover of the auto document feeder.

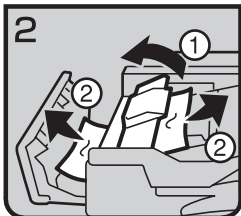

② Remove misfed originals.
③ Close the cover of the auto document feeder.

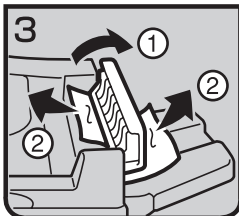

④ Open the cover of the auto document feeder and remove misfed originals.
⑤ Close the cover of the auto document feeder.

5

When C is lit

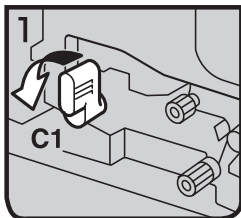

① Open the front cover of the machine.
② Pull down the C1 lever.

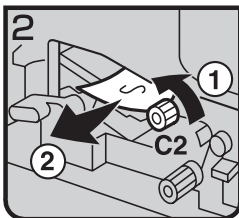

③ Turn the C2 knob and remove misfed paper.
④ Return lever C1 to original position.
⑤ Close the front cover.

When U is lit

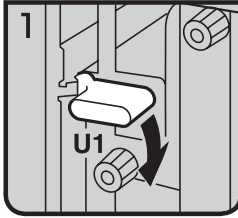

- ① Open the front cover of the machine.
② Hold down lever U1.

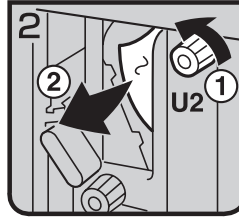

- ③ Turn knob U2 and remove misfed paper.
④ Return lever U1 to original position.

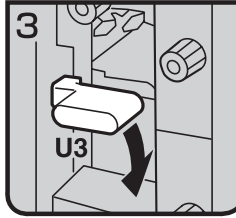

- ⑤ Hold down lever U3

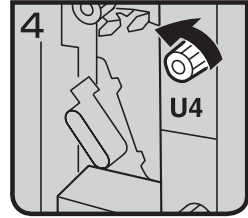

- ⑥ Turn knob U4.

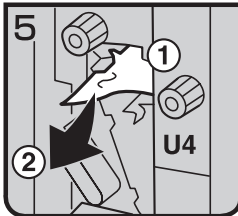

- ⑦ Remove misfed paper.

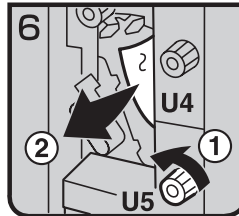

- ⑧ Turn knob U5 and remove misfed paper.

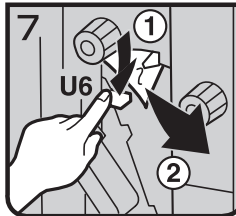

- ⑨ Hold down lever U6 and remove misfed paper.

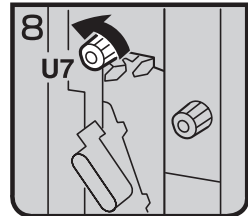

- ⑩ Turn knob U7 and remove misfed paper.
⑪ Return lever U3 to original position.
⑫ Close the front cover.

5

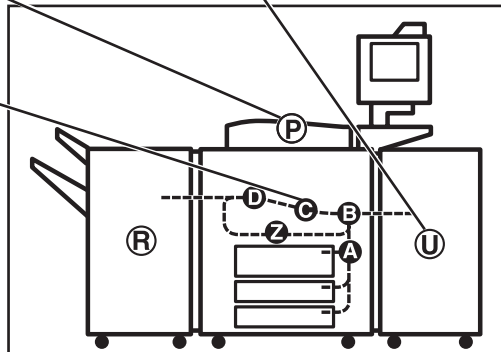

ZAKH080E

When R is lit

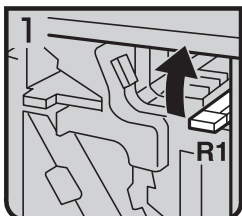

- ① Open the front cover of the machine.
- ② Hold up lever R1 and remove misfed paper.

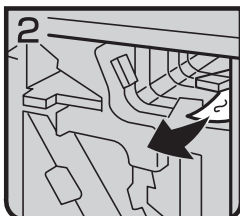

- ③ Remove misfed paper and return lever R1.

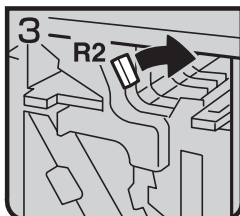

- ④ If you can not remove misfed paper, hold down lever R2.

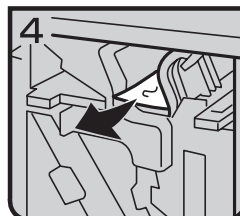

- ⑤ Remove misfed paper and return lever R2.

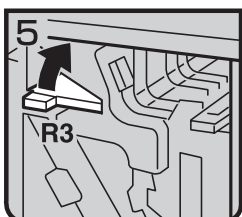

- ⑥ If you can not remove misfed paper, hold up lever R3.

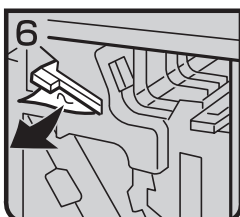

- ⑦ Remove misfed paper and return lever R3.

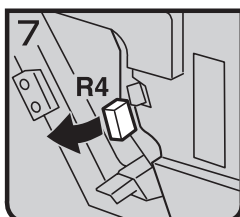

- ⑧ Hold up lever R4.



- ⑨ Remove misfed paper.

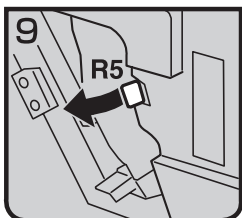

- ⑩ If you can not remove misfed paper, hold up lever R5.



- ⑪ Remove misfed paper.
- ⑫ Return lever R5 and R4 to the original position.

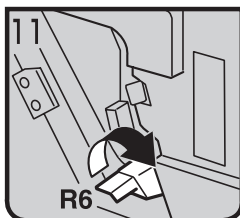

- ⑬ Hold up lever R6.

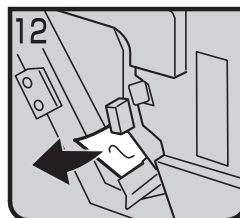

- ⑭ Remove misfed paper.
- ⑮ Return lever R6 to the original position.

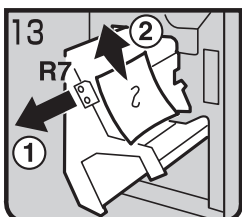

- ⑯ Pull lever R7 and fully pull out the staple unit, then remove misfed paper.
- ⑰ Return Staple unit to original position.
- ⑱ Close the front cover.

When D is lit

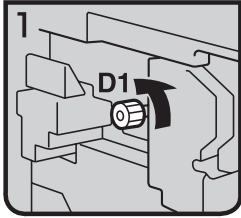

- ① Open the front cover of the machine.
② Turn knob D1 counterclockwise a few times.

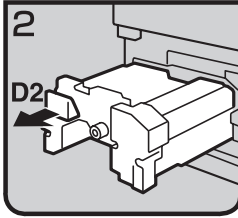

- ③ Pull lever D2 and fully pull out the fuser unit.

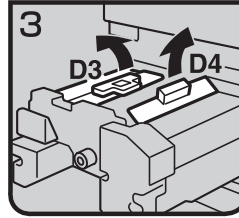

- ④ Hold up lever D3 and D4.

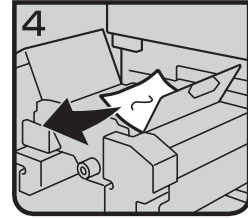

- ⑤ Remove misfed paper and return lever D3 and lever D4 to original position.

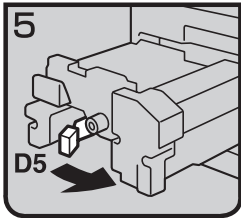

- ⑥ Turn lever D5.

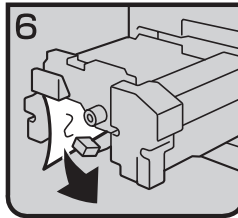

- ⑦ Remove misfed paper.

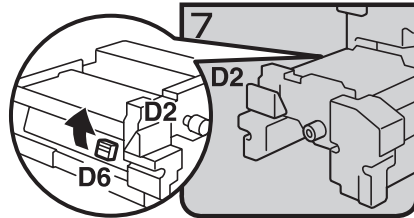

- ⑧ Hold up lever D6.

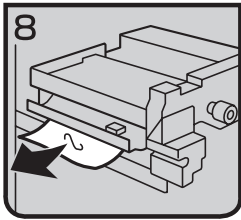

- ⑨ Remove misfed paper.
⑩ Return the fuser unit to original position.
⑪ Close the front cover.

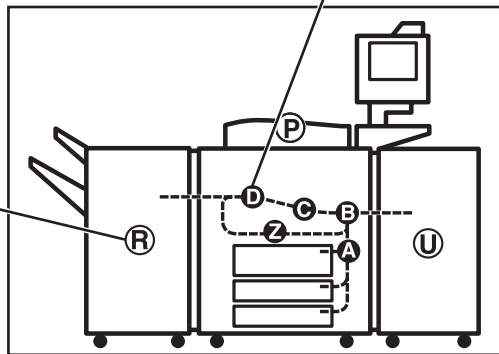

ZAKH060E

Changing the Paper Size

Important

- Always select the paper size loaded with the User Tools. If you do not, mis-feeds might occur.

Reference

For paper sizes, weight, and the amount of paper that can be set in each tray, see ⇒ P.18 "Copy Paper".

Changing the paper size in Tray 1

Note

- The fences of tray 1 (tandem tray) are fixed to A4, 8¹/₂" × 11" size. To change the paper size for this tray, please contact your service representative.

5

Changing the paper size in Tray 2 and Tray 3

- 1** Make sure that the paper tray is not being used. Then fully pull out the tray.

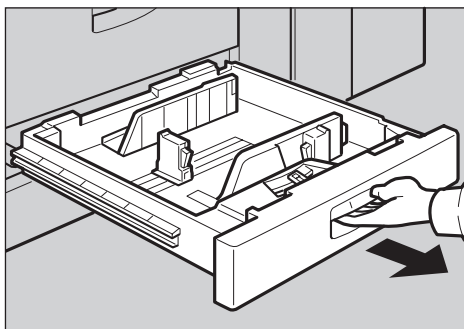

ZAJY040E

- 2** While pushing the release lever, adjust the side fences and back fence to the new paper size.

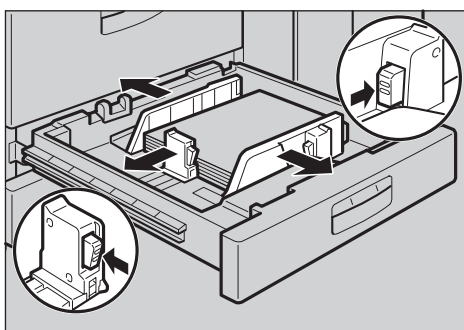

ZAKY400E

3 Square the paper and set it in the tray.

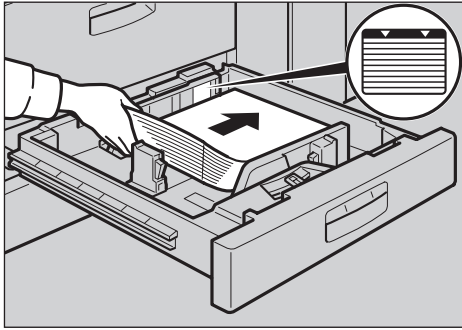

ZAJY050E

Important

- Do not set more than the capacity of the tray.
- Make sure that the paper stack is flush with the right side fence.

Note

- Fan the paper before placing it in the tray.
- Correct the paper, if curled or warped, before placing it in the tray.

4 Set the paper size selector at the outermost part of the tray to the new paper size.

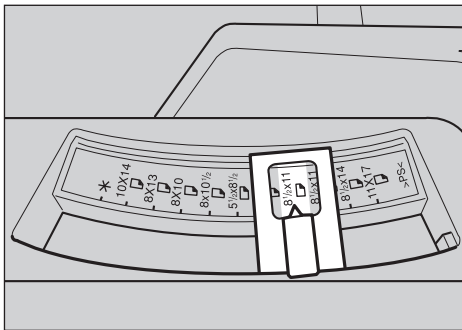

ZAJY450N

To adjust the paper size to one not available with the paper size selector

- 1 Set the paper size selector knob to the * mark on the left.
- 2 Press the [User Tools] key.
- 3 Press the [System Settings] key.
- 4 Press the [Paper Size Setting] key.
- 5 Press the [Tray 2:Paper Size Setting] key.
- 6 Select the paper size then press the [OK] key.
- 7 Press the [Exit] key or press the [User Tools] key to exit the User Tools.

 **Reference**

For details, see “User Tools” in the System Settings manual.

5 Push the paper tray until it stops.

6 Check the paper size displayed on the display panel.

Changing The Paper Size Of The Optional Large Capacity Tray (Tray 4 and Tray 5)

1 Make sure that the paper tray is not being used. Then fully pull out the tray.

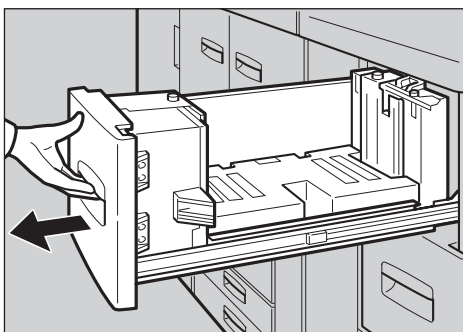

ZAJY090E

2 Pull out the screw fixed the side fence.

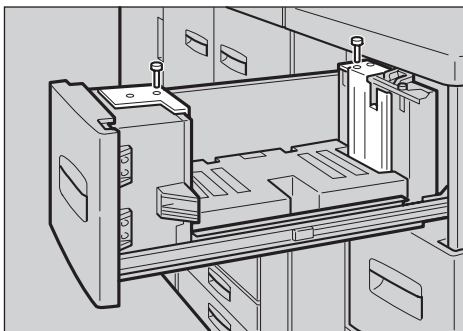

ZAJY460E

5

3 Set the side fence on the size you wish.

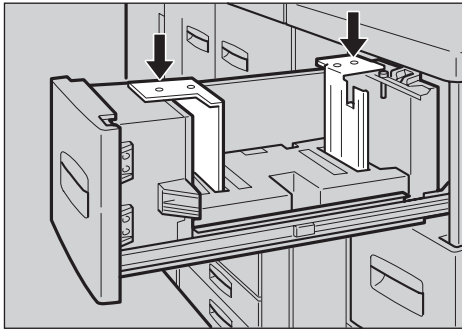

ZAJY470E

4 Fasten the side fence with the screw.

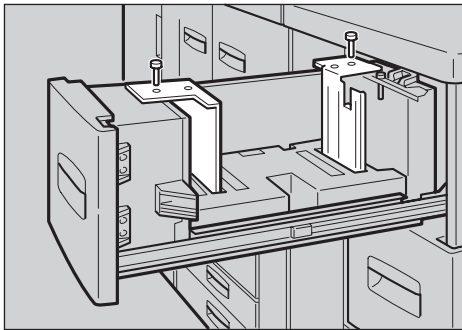

ZAJY480E

5 Set the end fence along the paper size.

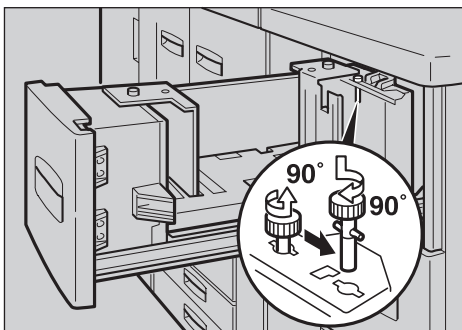

ZAJY490E

6 Square the paper and set it in the tray.

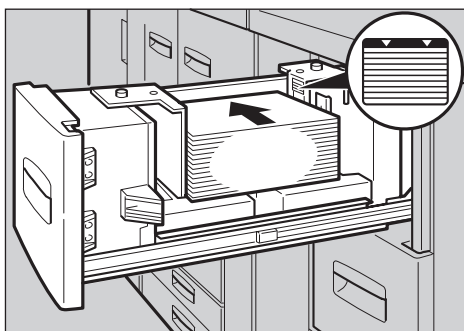

ZAJY500E

Important

- Do not load up over the mark of the least upper bound.

Note

- Fan the paper before placing it in the tray.
- If paper is curled or warped, correct the curl or warp before placing it in the tray.

7 Set the paper size selector at the innermost part of the tray to the new paper size.

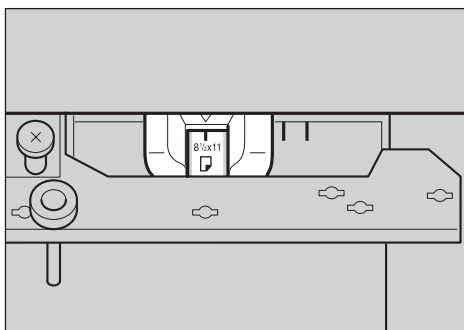

ZAJY510N

Changing The Paper Size Of The Optional Large Capacity Tray (Tray 6)

Note

- The fence of the optional large capacity tray (Tray 6) is fixed to A4, 8¹/₂" × 11" size.
- When you set the tab stocks in the tray, always use the end fence.

To change the paper size of this tray, contact your service representative.

Adding Staples

CAUTION:

- Our products are engineered to meet high standards of quality and functionality, and we recommend that you only use the expendable supplies available at an authorized dealer.

Important

- If you use a staple cartridge other than that recommended, staple failure or staple jams might occur.

- 1: Open the front cover of the finisher.

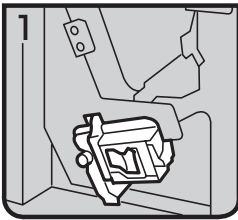

- 2: Pull the lever R8 down in the staple unit.
- 3: Turn knob R9 until the staple unit rises.

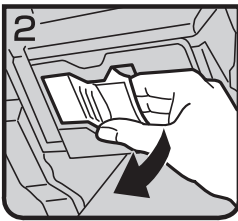

- 4: Pull out the staple unit lever.
- 5: Pull out the staple unit gently.

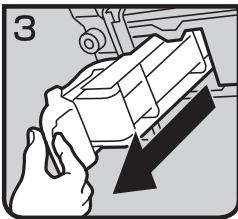

- 6: Put down the staple unit on a level surface.

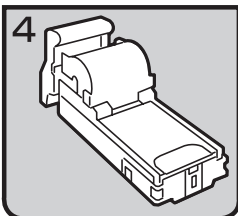

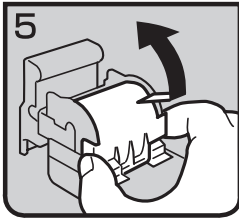

- 7: Raise the cover up.

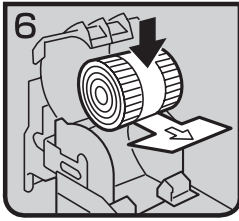

- 8: Set the new refill.

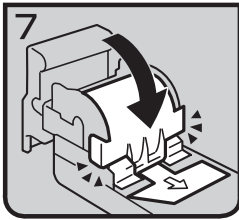

- 9: Lower the cover until it clicks.

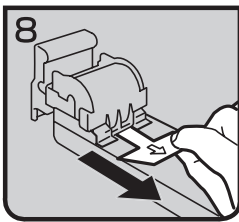

- 10: Pull out the ribbon.

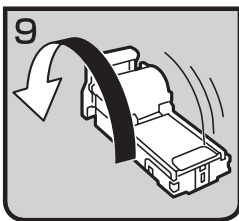

- 11: Turn the staple unit around.

- 12: Reinstall the staple unit.

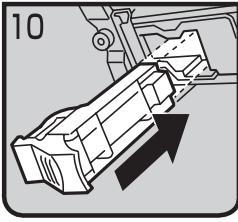

- 13: Push the staple unit until it clicks.

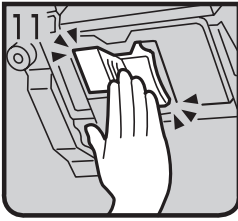

- 14: Close the front cover of the finisher.

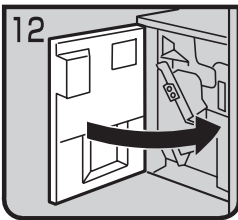

Removing Jammed Staples

Note

- ❑ Staples might be jammed because of curled copies. In this case, try turning the copy paper over in the tray. If there is no improvement, change to copy paper with less curl.
- ❑ After removing jammed staples, staples might not be ejected the first few times you try to use the stapler.

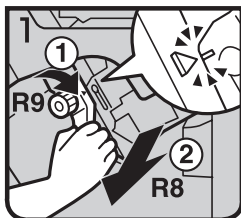

- 1: Open the front cover of the finisher and pull lever R9 down.
- 2: Pull lever R8 and fully pull out the staple unit.

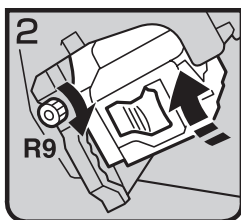

- 3: Turn knob R9 until the marks are aligned.

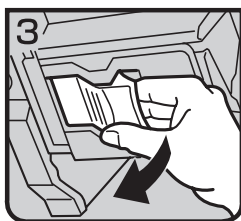

- 4: Pull out the staple unit lever.

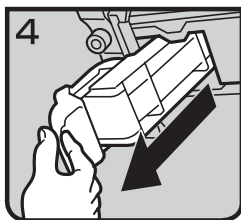

- 5: Pull out the staple unit gently.

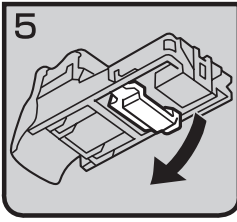

- 6: Raise the blue lever.

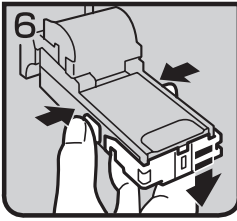

- 7: Push the buttons on the both sides of the staple unit and open the face plate.

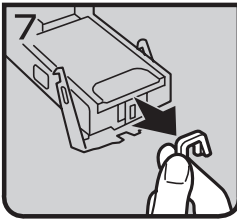

- 8: Pull out the jammed staples.

5

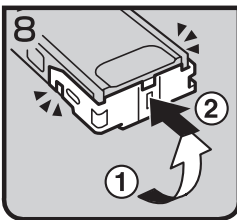

- 9: Lower the face plate until it clicks.

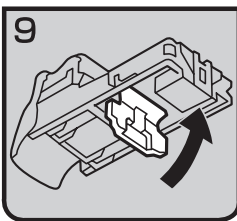

- 10: Lower the blue lever.

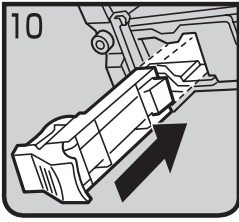

- 11: Reinstall the staple unit.

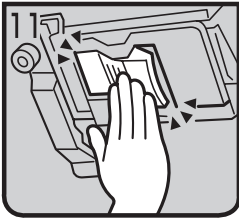

- 12: Push the staple unit until it clicks.

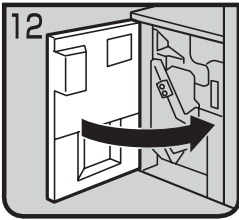

- 13: Replace the staple unit.
- 14: Close the front cover of the finisher.

Removing Punch Waste

Note

While the  indicator is lit you cannot use the punch function.

1 Open the front cover of the finisher.

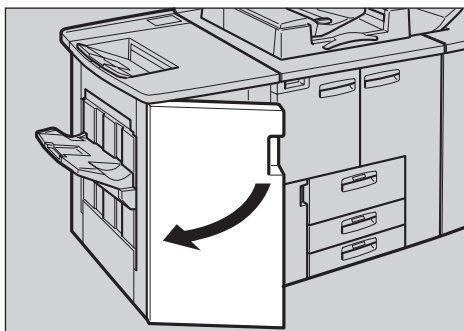

ZAKP010E

2 Pull out the punch waste box and remove punch waste.

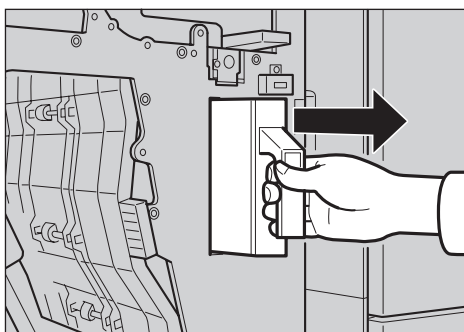

ZAKP020E

3 Reinstall the punch waste box.

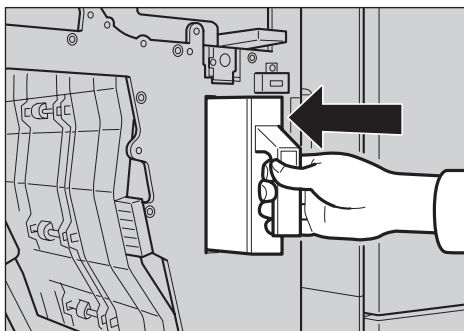

ZAKP030E

4 Close the front cover of the finisher.

The  indicator goes off.

 **Note**

- If the indicator is still lit, reinstall the punch waste box.

6. User Tools (Copier/Document Server Features)

Accessing User Tools (Copier/Document Server Features)

This section is for the key operators in charge of this machine. The User Tools permit you to change or set the machine's default settings.

Preparation

Always exit the User Tools menu when you have finished making settings.

Any changes you make with the User Tools remain in effect even if the main power switch or operation switch is turned off, or the **【Clear Modes】** key is pressed.

The key selected is highlighted.

Reference

For more information, see “Accessing The User Tools (System Settings)” in the System Settings manual.

1 Press the **【User Tools】** key.

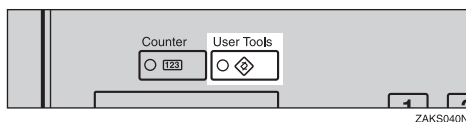

2 Press the **【Copier/Document Server Features】** key.

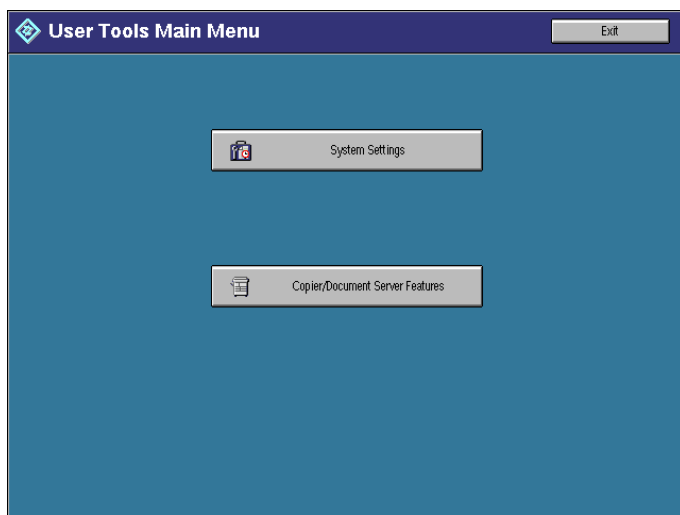

The main menu of the copy features is displayed.

3 Select the desired User Tools menu.

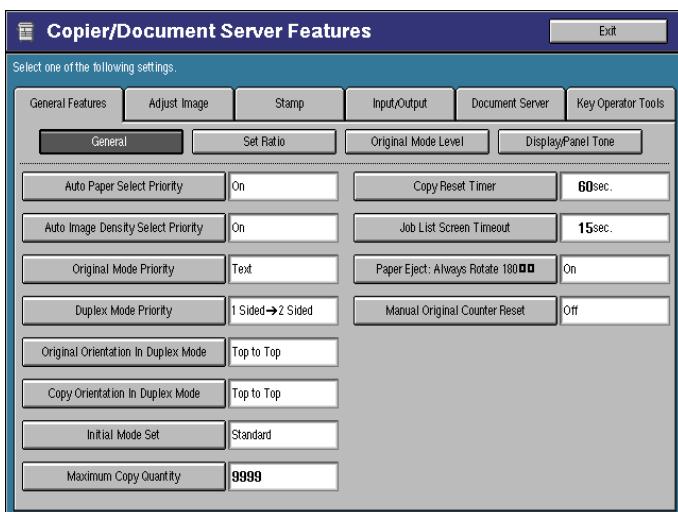

Reference

See ⇒ P.310 “User Tools Menu (Copier/Document Server Features)”.

6

4 Change the settings by following the instructions on the display panel. Then press the [OK] key.

Reference

See ⇒ P.312 “Settings You Can Change with the User Tools”.

Note

- [OK] key: Press to confirm the new settings and return to the previous menu.
- [Cancel] key: Press to return to the previous menu without changing any settings.

Exiting User Tools

1 Press the [Exit] key.

The initial copy display reappears and you can make copies.

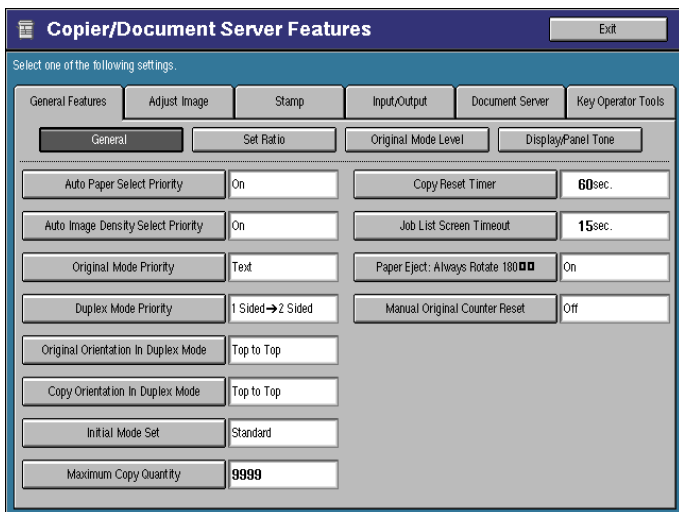

 **Note**

- User Tool settings are not canceled even if the operation switch is turned off or the **[User Tools]** key is pressed.
- You can exit User Tools by touching the **[User Tools]** key.

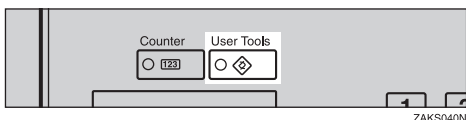

User Tools Menu (Copier/Document Server Features)

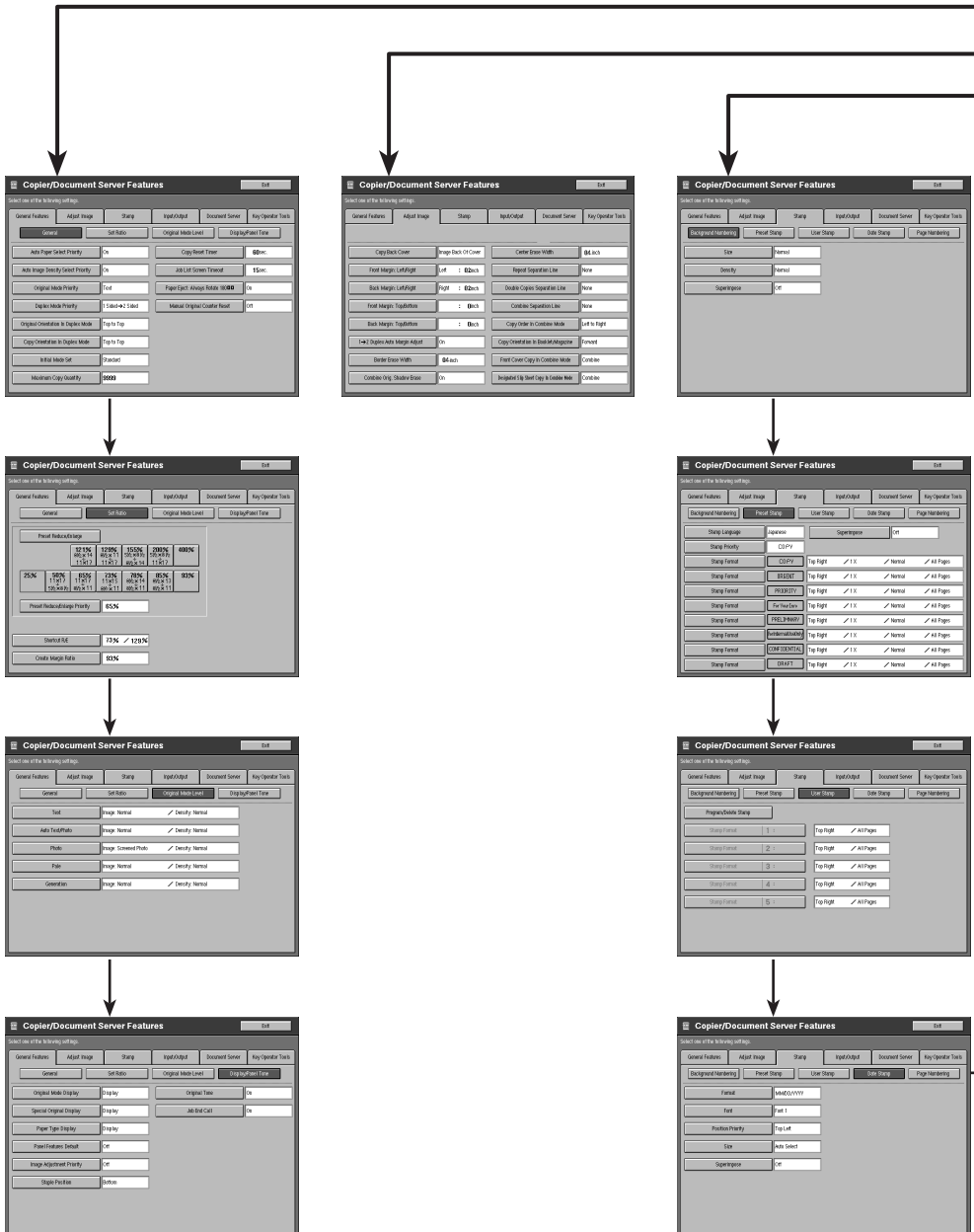
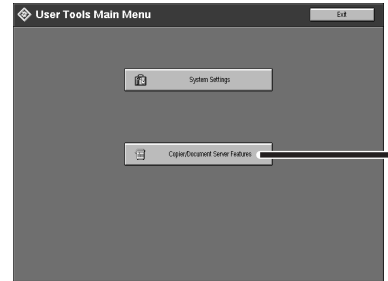

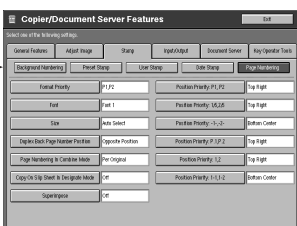
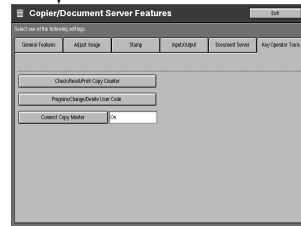
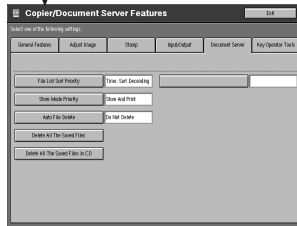
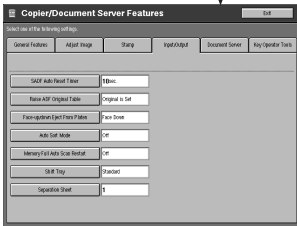
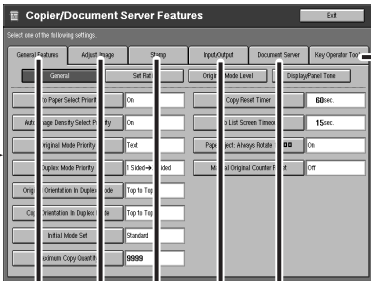





Settings You Can Change with the User Tools







Reference

For how to access the User Tools, see ⇒ P.307 “Accessing User Tools (Copier/Document Server Features)”.





General Features

General Features

Menu	Description
Auto Paper Select Priority	By default, Auto Paper Select is selected. You can cancel this setting.  Note <input type="checkbox"/> Default: <i>On</i>
Auto Image Density Select Priority	By default, Auto Image Density is selected. You can change this setting.  Note <input type="checkbox"/> Default: <i>On</i>
Original Mode Priority	By default, Text is selected as the Original Type. You can change it to Auto Text/Photo, Photo, Pale, or Generation.  Note <input type="checkbox"/> Default: <i>Text</i>
Duplex Mode Priority	You can select the type of Duplex function effective when the machine is turned on, Energy Saver mode exited, or an Auto Reset occurs.  Note <input type="checkbox"/> Default: <i>1 Sided → 2 Sided</i>
Original Orientation In Duplex Mode	You can set the original orientation when making two-sided copies.  Note <input type="checkbox"/> Default: <i>Top to Top</i>

Menu	Description
Copy Orientation In Duplex Mode	<p>You can set the copy orientation when making two-sided copies.</p> <p> Note <input type="checkbox"/> Default: <i>Top to Top</i></p>
Initial Mode Set	<p>You can select the initial mode or Program No. 25 as the mode effective when the machine is turned on, or modes are cleared.</p> <p> Note <input type="checkbox"/> Default: <i>Standard</i></p>
Maximum Copy Quantity	<p>The maximum copy quantity can be set between 1 and 9999.</p> <p> Note <input type="checkbox"/> Default: <i>9999</i></p>
Copy Reset Timer	<p>The machine returns to the initial condition automatically after your job is finished. The time can be set from 10 to 999 seconds, or off.</p> <p> Note <input type="checkbox"/> Default: <i>60 Sec.</i> <input type="checkbox"/> To turn the Copy Reset Timer off, select “Off”. <input type="checkbox"/> Note that when the Copy Reset Timer is turned off, the machine will not return to the user code input display automatically.</p>
Job List Screen Timeout	<p>The machine returns to its initial condition automatically from the Job List Screen. The time can be set from 10 to 999 seconds, or off.</p> <p> Note <input type="checkbox"/> Default: <i>15 Sec.</i> <input type="checkbox"/> To turn the Job List Screen Timeout off, select “Off”.</p>
Paper Eject : Always Rotate 180°	<p>If you want to copy on the paper with letterhead, the machine rotate the image correctly. To use this function turn it on.</p> <p> Note <input type="checkbox"/> Default: <i>Off</i></p>
Manual Original Counter Reset	<p>You can select the Manual Original Counter display turns on or off. The Original Counter can be reset by touching this key.</p> <p> Note <input type="checkbox"/> Default: <i>Off</i></p>





Set Ratio

Menu	Description
Preset Reduce/Enlarge	<p>When you use preset reduce/enlarge, you can select the ratios first displayed.</p> <p> Note</p> <p><input type="checkbox"/> Default: 25, 50, 65, 73, 78, 85, 93, 121, 129, 155, 200, 400 %</p>
Preset Reduce/Enlarge Priority	<p>You can select the ratio that is detected by priority in preset reduce/ enlarge mode.</p> <p> Note</p> <p><input type="checkbox"/> Default: 73%</p>
Shortcut R/E	<p>Up to 2 reproduction ratios which you frequently use can be registered.</p> <p> Note</p> <p><input type="checkbox"/> Default:</p> <ul style="list-style-type: none"> • Shortcut R/E 1 : 73 % • Shortcut R/E 2 : 129 %
Create Margin Ratio	<p>You can set the ratio of Create Margin.</p> <p>The ratio can be set from 90 to 99 %.</p> <p> Note</p> <p><input type="checkbox"/> Default: 93 %</p>

Original Mode Level





You can adjust the quality level of copies for each of the original types (Text, Auto Text/Photo, Photo, Pale, Generation).

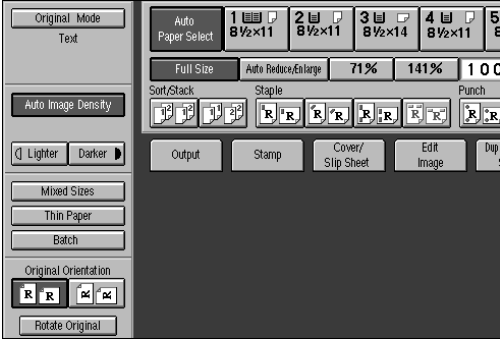
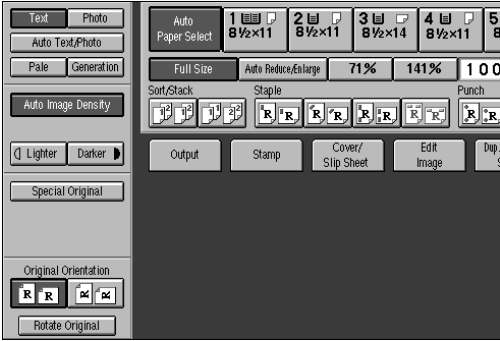

Menu	Description
Text	<p>① Adjust the sharpness of text.</p> <p>② Adjust the density of text.</p> <p> Note</p> <p><input type="checkbox"/> Default: <i>Normal</i></p> <p><input type="checkbox"/> [Service Mode] is the value set during service setup.</p> <p><input type="checkbox"/> Choosing [Soft] or [Sharp] affects the outline sharpness of text.</p>

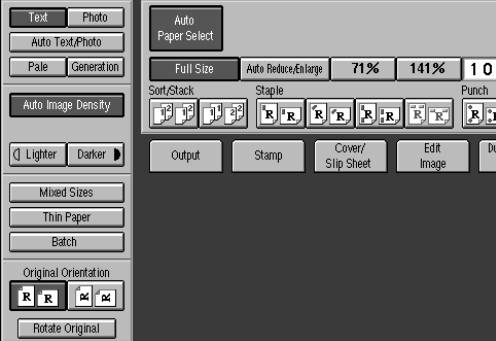
Menu	Description
Auto Text/Photo	<p>① When there are photo(s) and text on the original, this setting determines whether photo or text takes priority.</p> <p>② Adjust the density of Auto Text/Photo.</p> <p> Note</p> <ul style="list-style-type: none"> <input type="checkbox"/> Default: <i>Normal</i> <input type="checkbox"/> [Service Mode] is the value set during service setup. <input type="checkbox"/> [Normal] achieves a good balance between text and photos.
Photo	<p>① For a photo original, adjust the finish quality level to match the type of photo original.</p> <p>② Adjust the density.</p> <p> Note</p> <ul style="list-style-type: none"> <input type="checkbox"/> Default: <i>Normal</i> <input type="checkbox"/> If you change this setting during the document server function is using the finish image may differ. <input type="checkbox"/> [Service Mode] is the value set during service setup. <input type="checkbox"/> Select [Press Print] for printed photo originals with coarse dots, and [Glossy Photo] for printed photo originals with fine dots. <input type="checkbox"/> "Normal" is a well-balanced quality level for printed Photo, Pale, Photo, and Text.
Pale	<p>① Adjust the quality level for the finish of a pale original with normal density.</p> <p>② Adjust the density.</p> <p> Note</p> <ul style="list-style-type: none"> <input type="checkbox"/> Default: <i>Normal</i> <input type="checkbox"/> [Service Mode] is the value set during service setup.
Generation	<p>① Adjust the quality level so as not to thicken the lines of the finish image.</p> <p>② Adjust the density.</p> <p> Note</p> <ul style="list-style-type: none"> <input type="checkbox"/> Default: <i>Normal</i> <input type="checkbox"/> [Service Mode] is the value set during service setup.

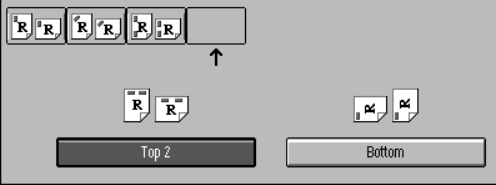
Display/Panel Tone



Menu	Description
<p>Original Mode Display</p>	<p>You can choose whether the original modes are shown on the initial display.</p> <p>Note</p> <ul style="list-style-type: none"> <input type="checkbox"/> Default: <i>Display</i> <input type="checkbox"/> If you choose “Hide”, the display is shown as below. 
<p>Special Original Display</p>	<p>You can choose whether the special original modes are shown on the initial display.</p> <p>Note</p> <ul style="list-style-type: none"> <input type="checkbox"/> Default: <i>Display</i> <input type="checkbox"/> If you choose “Hide”, the display is shown as below. 





Menu	Description
Paper Type Display	<p>You can choose whether the available paper trays/sizes are shown on the initial display.</p> <p> Note</p> <ul style="list-style-type: none"> <input type="checkbox"/> Default: <i>Display</i> <input type="checkbox"/> If you choose “Hide”, the display is shown as below. When the [Auto Paper Select] is touched, paper sizes appear on the display. 
Panel Features Default	<p>You can select the other tab function that is selected automatically just after the machine is turned on or when modes are cleared.</p> <p> Note</p> <ul style="list-style-type: none"> <input type="checkbox"/> Default: <i>Off</i>
Image Adjustment Priority	<p>You can select the function that is priority detected in Image Adjustment mode.</p> <p> Note</p> <ul style="list-style-type: none"> <input type="checkbox"/> Default: <i>Off</i>
Staple Position	<p>You can select the staple position to be displayed as the 4th icon.</p>  <p> Note</p> <ul style="list-style-type: none"> <input type="checkbox"/> Default: <i>Top 2</i>





Menu	Description
Original Tone	<p>The tone sounds when you forget to remove originals after copying.</p> <p> Note</p> <p><input type="checkbox"/> Default: <i>On</i></p> <p><input type="checkbox"/> If the Panel Tone is turned off, (see System Settings manual), the tone does not sound irrespective of the Original Tone function setting.</p>
Job End Call	<p>You can choose whether or not the tone sounds when copying is complete. You can set the volume of the tone that with the User Tools (System Settings), and the tone that sounds when the paper tray runs out of paper or when there is a paper jam.</p> <p> Note</p> <p><input type="checkbox"/> Default: <i>On</i></p>



Adjust Image

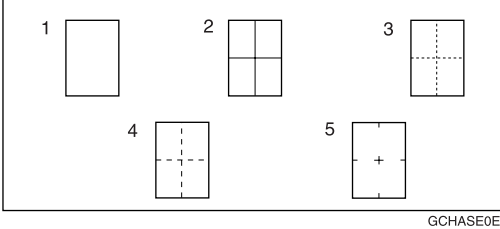

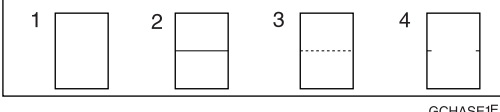

6

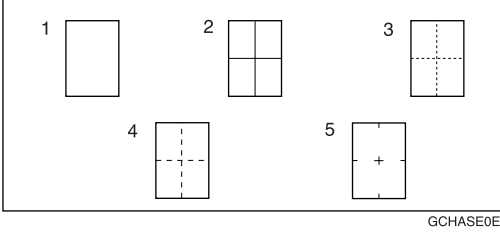
Menu	Description
Copy Back Cover	<p>When copying single sided covers, choose whether the outside back cover is delivered face up or face down.</p> <p> Note</p> <p><input type="checkbox"/> Default: <i>Image Back Of Cover</i></p>
Front Margin: Left/Right	<p>You can specify left or right margins on the front side of copies in Margin Adjust mode.</p> <p> Note</p> <p><input type="checkbox"/> Default:</p> <ul style="list-style-type: none"> • Metric version: <i>Left 5 mm</i> • Inch version: <i>Left 0.2"</i>
Back Margin: Left/Right	<p>You can specify left or right margins on the back side of copies in Margin Adjust mode.</p> <p> Note</p> <p><input type="checkbox"/> Default:</p> <ul style="list-style-type: none"> • Metric version: <i>Right 5 mm</i> • Inch version: <i>Right 0.2"</i>

Menu	Description
Front Margin: Top/Bottom	<p>You can specify front top and bottom margins on the front side of copies in Margin Adjust mode.</p> <p> Note</p> <p><input type="checkbox"/> Default:</p> <ul style="list-style-type: none"> • Metric version: <i>Bottom 0 mm</i> • Inch version: <i>Bottom 0.0"</i>
Back Margin: Top/Bottom	<p>You can specify the top, or bottom margins on the back side of copies in Margin Adjust mode.</p> <p> Note</p> <p><input type="checkbox"/> Default:</p> <ul style="list-style-type: none"> • Metric version: <i>Bottom 0 mm</i> • Inch version: <i>Bottom 0.0"</i>
1 → 2 Duplex Auto Margin Adjust	<p>In 1 sided → 2 sided Duplex mode, you can specify whether to automatically set the margins on the back side.</p> <p>The margin is set the same value of the "Back Margin: Left/Right".</p> <p> Note</p> <p><input type="checkbox"/> Default: <i>On</i></p>
Border Erase Width	<p>The default width of erased margins in Border Erase mode can be changed as follows:</p> <ul style="list-style-type: none"> • Metric version: 3–50 mm in 1 mm steps • Inch version: 0.1–2.0" in 0.1" steps <p> Note</p> <p><input type="checkbox"/> Default:</p> <ul style="list-style-type: none"> • Metric version: <i>10 mm</i> • Inch version: <i>0.4"</i>
Combine Orig. Shadow Erase	<p>In Combine Copy or Booklet/Magazine Copy mode, you can specify whether to erase a 3 mm, 0.1" binding margin around all four edges of each copy.</p> <p> Note</p> <p><input type="checkbox"/> Default: <i>Yes</i></p>



Menu	Description
Center Erase Width	<p>The default width of erased margins in Erase Center mode can be changed as follows:</p> <ul style="list-style-type: none"> • Metric version: 3–50 mm in 1 mm steps • Inch version: 0.1–2.0" in 0.1" steps <p> Note</p> <p><input type="checkbox"/> Default:</p> <ul style="list-style-type: none"> • Metric version: 10 mm • Inch version: 0.4"
Repeat Separation Line	<p>You can select a the kind of separation line in Image Repeat mode from the following:</p> <div data-bbox="504 658 1002 884" style="border: 1px solid black; padding: 5px; margin: 10px 0;">  <p style="text-align: right; font-size: small;">GCHASE0E</p> </div> <ul style="list-style-type: none"> • 1: None • 2: Solid • 3: Broken 1 • 4: Broken 2 • 5: Crop Marks <p> Note</p> <p><input type="checkbox"/> Default: <i>None</i></p>
Double Copies Separation Line	<p>You can select the kind of separation line in Double Copy mode from the following:</p> <div data-bbox="504 1315 1002 1425" style="border: 1px solid black; padding: 5px; margin: 10px 0;">  <p style="text-align: right; font-size: small;">GCHASE1E</p> </div> <ul style="list-style-type: none"> • 1: None • 2: Solid • 3: Broken • 4: Crop Marks <p> Note</p> <p><input type="checkbox"/> Default: <i>None</i></p>

Menu	Description
Combine Separation Line	<p>You can select the kind of separation line in Combine mode from the following:</p>  <ul style="list-style-type: none">• None• Solid• Broken 1• Broken 2• Crop Marks <p> Note</p> <p><input type="checkbox"/> Default: <i>None</i></p>



Menu	Description																																																																																																			
<p>Copy Order In Combine Mode</p>	<p>You can set the copy order in Combine mode to “Left to Right” or “Top to Bottom”.</p> <table border="1" data-bbox="504 305 1002 1058"> <thead> <tr> <th></th> <th>Top to Top</th> <th>Top to Bottom</th> </tr> </thead> <tbody> <tr> <td>1 Sided 4 originals → 1 Side Combine</td> <td> <table border="1"> <tr><td>1</td><td>2</td></tr> <tr><td>3</td><td>4</td></tr> </table> </td> <td> <table border="1"> <tr><td>1</td><td>3</td></tr> <tr><td>2</td><td>4</td></tr> </table> </td> </tr> <tr> <td>1 Sided 8 originals → 1 Side Combine</td> <td> <table border="1"> <tr><td>1</td><td>2</td><td>3</td><td>4</td></tr> <tr><td>5</td><td>6</td><td>7</td><td>8</td></tr> </table> </td> <td> <table border="1"> <tr><td>1</td><td>3</td><td>5</td><td>7</td></tr> <tr><td>2</td><td>4</td><td>6</td><td>8</td></tr> </table> </td> </tr> <tr> <td>1 Sided 8 originals → 2 Side Combine</td> <td> <table border="1"> <tr> <td>Front</td> <td>Back</td> </tr> <tr><td>1</td><td>2</td><td>5</td><td>6</td></tr> <tr><td>3</td><td>4</td><td>7</td><td>8</td></tr> </table> </td> <td> <table border="1"> <tr> <td>Front</td> <td>Back</td> </tr> <tr><td>1</td><td>3</td><td>5</td><td>7</td></tr> <tr><td>2</td><td>4</td><td>6</td><td>8</td></tr> </table> </td> </tr> <tr> <td>1 Sided 16 originals → 2 Side Combine</td> <td> <table border="1"> <tr> <td>Front</td> <td>Back</td> </tr> <tr><td>1</td><td>2</td><td>3</td><td>4</td></tr> <tr><td>5</td><td>6</td><td>7</td><td>8</td></tr> <tr> <td>Back</td> <td>Back</td> </tr> <tr><td>9</td><td>10</td><td>11</td><td>12</td></tr> <tr><td>13</td><td>14</td><td>15</td><td>16</td></tr> </table> </td> <td> <table border="1"> <tr> <td>Front</td> <td>Back</td> </tr> <tr><td>1</td><td>3</td><td>5</td><td>7</td></tr> <tr><td>2</td><td>4</td><td>6</td><td>8</td></tr> <tr> <td>Back</td> <td>Back</td> </tr> <tr><td>9</td><td>11</td><td>13</td><td>15</td></tr> <tr><td>10</td><td>12</td><td>14</td><td>16</td></tr> </table> </td> </tr> </tbody> </table> <p style="text-align: right; font-size: small;">GCCOMB9E</p> <p> Note <input type="checkbox"/> Default: <i>Left to Right</i></p>		Top to Top	Top to Bottom	1 Sided 4 originals → 1 Side Combine	<table border="1"> <tr><td>1</td><td>2</td></tr> <tr><td>3</td><td>4</td></tr> </table>	1	2	3	4	<table border="1"> <tr><td>1</td><td>3</td></tr> <tr><td>2</td><td>4</td></tr> </table>	1	3	2	4	1 Sided 8 originals → 1 Side Combine	<table border="1"> <tr><td>1</td><td>2</td><td>3</td><td>4</td></tr> <tr><td>5</td><td>6</td><td>7</td><td>8</td></tr> </table>	1	2	3	4	5	6	7	8	<table border="1"> <tr><td>1</td><td>3</td><td>5</td><td>7</td></tr> <tr><td>2</td><td>4</td><td>6</td><td>8</td></tr> </table>	1	3	5	7	2	4	6	8	1 Sided 8 originals → 2 Side Combine	<table border="1"> <tr> <td>Front</td> <td>Back</td> </tr> <tr><td>1</td><td>2</td><td>5</td><td>6</td></tr> <tr><td>3</td><td>4</td><td>7</td><td>8</td></tr> </table>	Front	Back	1	2	5	6	3	4	7	8	<table border="1"> <tr> <td>Front</td> <td>Back</td> </tr> <tr><td>1</td><td>3</td><td>5</td><td>7</td></tr> <tr><td>2</td><td>4</td><td>6</td><td>8</td></tr> </table>	Front	Back	1	3	5	7	2	4	6	8	1 Sided 16 originals → 2 Side Combine	<table border="1"> <tr> <td>Front</td> <td>Back</td> </tr> <tr><td>1</td><td>2</td><td>3</td><td>4</td></tr> <tr><td>5</td><td>6</td><td>7</td><td>8</td></tr> <tr> <td>Back</td> <td>Back</td> </tr> <tr><td>9</td><td>10</td><td>11</td><td>12</td></tr> <tr><td>13</td><td>14</td><td>15</td><td>16</td></tr> </table>	Front	Back	1	2	3	4	5	6	7	8	Back	Back	9	10	11	12	13	14	15	16	<table border="1"> <tr> <td>Front</td> <td>Back</td> </tr> <tr><td>1</td><td>3</td><td>5</td><td>7</td></tr> <tr><td>2</td><td>4</td><td>6</td><td>8</td></tr> <tr> <td>Back</td> <td>Back</td> </tr> <tr><td>9</td><td>11</td><td>13</td><td>15</td></tr> <tr><td>10</td><td>12</td><td>14</td><td>16</td></tr> </table>	Front	Back	1	3	5	7	2	4	6	8	Back	Back	9	11	13	15	10	12	14	16
	Top to Top	Top to Bottom																																																																																																		
1 Sided 4 originals → 1 Side Combine	<table border="1"> <tr><td>1</td><td>2</td></tr> <tr><td>3</td><td>4</td></tr> </table>	1	2	3	4	<table border="1"> <tr><td>1</td><td>3</td></tr> <tr><td>2</td><td>4</td></tr> </table>	1	3	2	4																																																																																										
1	2																																																																																																			
3	4																																																																																																			
1	3																																																																																																			
2	4																																																																																																			
1 Sided 8 originals → 1 Side Combine	<table border="1"> <tr><td>1</td><td>2</td><td>3</td><td>4</td></tr> <tr><td>5</td><td>6</td><td>7</td><td>8</td></tr> </table>	1	2	3	4	5	6	7	8	<table border="1"> <tr><td>1</td><td>3</td><td>5</td><td>7</td></tr> <tr><td>2</td><td>4</td><td>6</td><td>8</td></tr> </table>	1	3	5	7	2	4	6	8																																																																																		
1	2	3	4																																																																																																	
5	6	7	8																																																																																																	
1	3	5	7																																																																																																	
2	4	6	8																																																																																																	
1 Sided 8 originals → 2 Side Combine	<table border="1"> <tr> <td>Front</td> <td>Back</td> </tr> <tr><td>1</td><td>2</td><td>5</td><td>6</td></tr> <tr><td>3</td><td>4</td><td>7</td><td>8</td></tr> </table>	Front	Back	1	2	5	6	3	4	7	8	<table border="1"> <tr> <td>Front</td> <td>Back</td> </tr> <tr><td>1</td><td>3</td><td>5</td><td>7</td></tr> <tr><td>2</td><td>4</td><td>6</td><td>8</td></tr> </table>	Front	Back	1	3	5	7	2	4	6	8																																																																														
Front	Back																																																																																																			
1	2	5	6																																																																																																	
3	4	7	8																																																																																																	
Front	Back																																																																																																			
1	3	5	7																																																																																																	
2	4	6	8																																																																																																	
1 Sided 16 originals → 2 Side Combine	<table border="1"> <tr> <td>Front</td> <td>Back</td> </tr> <tr><td>1</td><td>2</td><td>3</td><td>4</td></tr> <tr><td>5</td><td>6</td><td>7</td><td>8</td></tr> <tr> <td>Back</td> <td>Back</td> </tr> <tr><td>9</td><td>10</td><td>11</td><td>12</td></tr> <tr><td>13</td><td>14</td><td>15</td><td>16</td></tr> </table>	Front	Back	1	2	3	4	5	6	7	8	Back	Back	9	10	11	12	13	14	15	16	<table border="1"> <tr> <td>Front</td> <td>Back</td> </tr> <tr><td>1</td><td>3</td><td>5</td><td>7</td></tr> <tr><td>2</td><td>4</td><td>6</td><td>8</td></tr> <tr> <td>Back</td> <td>Back</td> </tr> <tr><td>9</td><td>11</td><td>13</td><td>15</td></tr> <tr><td>10</td><td>12</td><td>14</td><td>16</td></tr> </table>	Front	Back	1	3	5	7	2	4	6	8	Back	Back	9	11	13	15	10	12	14	16																																																										
Front	Back																																																																																																			
1	2	3	4																																																																																																	
5	6	7	8																																																																																																	
Back	Back																																																																																																			
9	10	11	12																																																																																																	
13	14	15	16																																																																																																	
Front	Back																																																																																																			
1	3	5	7																																																																																																	
2	4	6	8																																																																																																	
Back	Back																																																																																																			
9	11	13	15																																																																																																	
10	12	14	16																																																																																																	
<p>Copy Orientation In Booklet/Magazine</p>	<p>You can select the type of originals for Booklet or Magazine mode.</p> <p> Note <input type="checkbox"/> Default: <i>Forward</i></p>																																																																																																			
<p>Front Cover Copy In Combine Mode</p>	<p>You can specify whether to make a combined copy on the front cover sheet when you select [copy] in Front Cover mode.</p> <p> Note <input type="checkbox"/> Default: <i>Combine</i></p>																																																																																																			
<p>Designated Slip Sheet Copy In Combine Mode</p>	<p>You can specify whether to make a combined copy on the inserted slip sheets in Designate: Copy mode.</p> <p> Note <input type="checkbox"/> Default: <i>Combine</i></p>																																																																																																			





Stamp

Background Numbering



Menu	Description
Size	<p>You can set the size of the numbers.</p> <p> Note</p> <p><input type="checkbox"/> Default: <i>Normal</i></p> <ul style="list-style-type: none"> • Small: 8 × 4mm, 0.32" × 0.16" • Normal: 32 × 16mm, 1.28" × 0.64" • Large: 64 × 32mm, 2.56" × 1.28"
Density	<p>You can set the density of the numbers.</p> <p> Note</p> <p><input type="checkbox"/> Default: <i>Normal</i></p>
Superimpose	<p>You can select whether the numbering is printed negative when it overlaps black parts of the image.</p> <p> Note</p> <p><input type="checkbox"/> Default: <i>Off</i></p>

Preset Stamp



Menu	Description
Stamp Language	<p>You can select the language of the message that is printed in Stamp mode.</p> <p> Note</p> <p><input type="checkbox"/> Default: <i>English</i></p>
Stamp Priority	<p>You can select the stamp type priority detected in Stamp mode.</p> <p> Note</p> <p><input type="checkbox"/> Default: <i>COPY</i></p>



Menu	Description
Stamp Format You can adjust the position, size, density and print page for the stamp.	
Position Priority	You can set the stamp position.  Note <input type="checkbox"/> Default: <ul style="list-style-type: none"> • Metric version: <ul style="list-style-type: none"> • Position: <i>Top Right</i> • Top/Bottom Margin: <i>24mm</i> • Left/Right Margin: <i>24mm</i> • Inch version: <ul style="list-style-type: none"> • Position: <i>Top Right</i> • Top/Bottom Margin: <i>10"</i> • Left/Right Margin: <i>10"</i> <input type="checkbox"/>
Size	You can set the size of the stamp.  Note <input type="checkbox"/> Default: 1x
Density	You can set the pattern used to print the stamp.  Note <input type="checkbox"/> Default: <i>Normal</i> <input type="checkbox"/> Normal: The stamp is printed on the image. You cannot confirm which parts overlap the image. <input type="checkbox"/> Lighter: The image can be seen through the stamp. <input type="checkbox"/> Light: You can see the image even more than the "Lighter" setting.
Print Page	You can select whether the stamp is printed on the first page or all pages.  Note <input type="checkbox"/> Default: <i>All Pages</i>
Superimpose	You can select whether the Preset Stamp is printed negative when it overlaps black parts of the image.  Note <input type="checkbox"/> Default: <i>Off</i>

User Stamp



Menu	Description
Program/Delete Stamp	<p>You can register up to 5 custom stamps with your favorite design. You can register/change/delete your favorite design as a user stamp.</p> <p>How to Program/Delete Stamp See ⇒ P.174 “Program/Delete User Stamp”</p>
Position : Stamp Format 1–5	<p>You can set the position at which the stamp is printed. Press the arrow keys to adjust the position.</p> <p> Note</p> <p><input type="checkbox"/> Default:</p> <ul style="list-style-type: none"> • Metric version: <ul style="list-style-type: none"> • Position: <i>Top Right</i> • Top/Bottom Margin: <i>24mm</i> • Left/Right Margin: <i>24mm</i> • Inch version: <ul style="list-style-type: none"> • Position: <i>Top Right</i> • Top/Bottom Margin: <i>10”</i> • Left/Right Margin: <i>10”</i>
Print Page	<p>You can select whether the stamp is printed on the first page or all pages.</p> <p> Note</p> <p><input type="checkbox"/> Default: <i>All Pages</i></p>







Date Stamp

Menu	Description
Format	<p>You can select the date format for Date Stamp mode.</p> <p> Note</p> <p><input type="checkbox"/> Default: <i>01/01/2000</i></p>
Font	<p>You can select the Date Stamp font.</p> <p> Note</p> <p><input type="checkbox"/> Default: <i>Gothic</i></p> <p><input type="checkbox"/> This setting is linked with Page Numbering.</p>







Menu	Description
Position Priority	<p>You can set the position at which the stamp is printed. Press the arrow keys to adjust the position.</p> <p> Note</p> <p><input type="checkbox"/> Default:</p> <ul style="list-style-type: none"> • Metric version <ul style="list-style-type: none"> • Position: <i>Top Left</i> • Top/Bottom Margin: <i>8mm</i> • Left/Right Margin: <i>32mm</i> • Inch version <ul style="list-style-type: none"> • Position: <i>Top Left</i> • Top/Bottom Margin: <i>0.3"</i> • Left/Right Margin: <i>0.8"</i>
Size	<p>You can set the Date Stamp size.</p> <p> Note</p> <p><input type="checkbox"/> Default: <i>Auto Select</i></p> <p><input type="checkbox"/> This setting is linked with Page Numbering.</p>
Superimpose	<p>You can select whether the Preset Stamp is printed negative it overlaps black parts of the image.</p> <p> Note</p> <p><input type="checkbox"/> Default: <i>Off</i></p> <p><input type="checkbox"/> This setting is linked with Page Numbering.</p>

Page Numbering

Menu	Description
Format	<p>You can select the page number format that is printed in Page Numbering mode.</p> <p> Note</p> <p><input type="checkbox"/> Default: <i>P1, P2</i></p>
Font	<p>You can select the font of the page number that is printed in Page Numbering mode.</p> <p> Note</p> <p><input type="checkbox"/> Default: <i>Gothic</i></p> <p><input type="checkbox"/> This setting is linked with the Date Stamp.</p>







Menu	Description
Size	<p>You can set the size of the stamp that is printed in Page Numbering mode.</p> <p> Note</p> <p><input type="checkbox"/> Default: <i>Auto Select</i></p> <p><input type="checkbox"/> This setting is linked with the Date Stamp.</p>
Duplex Back Page Number Position	<p>You can set the position of the duplex back page number that is printed in Duplex mode.</p> <p> Note</p> <p><input type="checkbox"/> Default: <i>Opposite Position</i></p>
Page Numbering In Combine Mode	<p>You can set how the pages are numbered when you use the Combine function and Page Numbering function together.</p> <p> Note</p> <p><input type="checkbox"/> Default: <i>Per Original</i></p>
Copy On Slip Sheet In Designate Mode	<p>You can select whether to print the page number onto slip sheets when you use the Designate function, “Copy” and Page Numbering together.</p> <p> Note</p> <p><input type="checkbox"/> Default: <i>Off</i></p> <p><input type="checkbox"/> If you combine with the Designate function, you can use only 1-1, 1-2... format.</p>
Superimpose	<p>You can select whether page numbers are printed negative when they overlap black parts of the image.</p> <p> Note</p> <p><input type="checkbox"/> Default: <i>Off</i></p>
Position Priority Position : P1, P2, Position : 1/5, 2/5 Position : -1-, -2- Position : P.1, P.2 Position : 1, 2 Position : 1-1, 1-2	<p>You can set the position.</p> <p>Press the arrow keys to adjust the position.</p> <p> Note</p> <p><input type="checkbox"/> Default:</p> <ul style="list-style-type: none"> • Metric version <ul style="list-style-type: none"> • Position: P.1, P1, 1, 1/5: <i>Top Right</i>, -1-, 1-1: <i>Bottom Center</i> • Margin: P.1, P1, 1, 1/5: <i>12mm</i>, -1-, 1-1: <i>8mm</i> • Inch version <ul style="list-style-type: none"> • Position: P.1, P1, 1, 1/5: <i>Top Right</i>, -1-, 1-1: <i>Bottom Center</i> • Margin: P.1, P1, 1, 1/5: <i>5"</i>, -1-, 1-1: <i>3"</i>

Input/Output

Menu	Description
SADF Auto Reset Timer	<p>When you set one original at a time in the optional document feeder, the Auto Feed indicator lights for a time after the last original is fed to show that the document feeder is ready for another original. You can adjust this time from 3 seconds to 99.</p> <p> Note <input type="checkbox"/> Default: <i>10 seconds</i></p>
ADF Original Table Rise Time	<p>You can set the document feeder original table rise time.</p> <p> Note <input type="checkbox"/> Default: <i>Original is Set</i></p>
Face-up/down Eject From Platen	<p>When copying an original placed on the exposure glass or one original loaded in the document feeder, you can specify the way copies are delivered.</p> <p> Note <input type="checkbox"/> Default: <i>Face Up</i></p>
Auto Sort Mode	<p>You can specify whether Sort mode is selected when the machine is turned on or when modes are cleared.</p> <p> Note <input type="checkbox"/> Default: <i>Off</i></p>
Memory Full Auto Scan Restart	<p>If memory runs out while scanning originals, the machine can make copies of the scanned originals first, then automatically proceed with scanning the remaining originals. You can enable or disable this function.</p> <ul style="list-style-type: none"> • If you select [On]: When the memory becomes full, the machine stops allowing you to remove the copy pages delivered on the output tray. • If you select [Off]: You can leave the machine unattended to make all the copies, but the resulting sorted pages will not be in sequence. <p> Note <input type="checkbox"/> Default: <i>Off</i></p>
Shift Tray	<p>You can have copies shifted in sort or stack mode.</p> <p> Note <input type="checkbox"/> Default: <i>Standard</i></p>



Menu	Description
Separation Sheet	<p>You can set the number of separation sheets that is inserted (1-999).</p> <p> Note</p> <p><input type="checkbox"/> Default: 1</p>

Document Server

Menu	Description
File List Sort Priority	<p>You can select how files that are listed in Document Server mode.</p> <p> Note</p> <p><input type="checkbox"/> Default: <i>Time : Sort Descending</i></p>
Store Mode Priority	<p>By default, "Store And Print" is selected.</p> <p>You can cancel this setting.</p> <p> Note</p> <p><input type="checkbox"/> Default: <i>Store And Print</i></p>
Auto File Delete	<p>Old files stored on the Document Server can be deleted automatically.</p> <p> Note</p> <p><input type="checkbox"/> Default: <i>Do Not Delete</i></p> <p><input type="checkbox"/> When you select Delete, input the time using the number keys. The time can be set from 1 to 180 days in 1 day steps.</p>
Delete All The Saved Files, Delete All The Saved Files In CD	<p>You can delete all saved files.</p> <p>If you have registered the access code, you need to input the code before you can delete files.</p> <p> Limitation</p> <p><input type="checkbox"/> You can not delete files that are currently in use.</p> <p> Note</p> <p><input type="checkbox"/> The message dialog is displayed. If you want to delete all files, press [Yes] key, If you do not, press [No] key to cancel.</p>
CD Read/Write Speed Control	<p>You can select the access speed for CD-RW.</p> <p> Note</p> <p><input type="checkbox"/> Default: <i>Auto</i></p>

Key Operator Tools

If the key operator code has been registered beforehand, you cannot access the Key Operator Tools unless you enter the key operator code (up to 8 digits).

Menu	Description
Check/Reset/Print Copy Counter	<p>You can check or print the number of copies made under each user code.</p> <p>You can also reset each user code counter to 0.</p> <p>If more than 20 user codes are registered, you can view all the counters using the [Previous] or [Next] key.</p>
Print Counter List	<p>You can print the number of copies under each user code.</p> <p>To start printing, press the [Print Counter List] key. To stop printing, touch the [Cancel] key.</p>
Reset Counters	You can reset each user code counter to 0.
Reset All Counters	You can reset all counters to 0.
Program/Change/Delete User Code	<p>You can register, change, or delete user codes (8 digits or less).</p> <p> Note</p> <ul style="list-style-type: none"> <input type="checkbox"/> Up to 500 user codes can be registered. <input type="checkbox"/> Even if you have changed a user code, the counter value will not be cleared. <input type="checkbox"/> When the user code is deleted, the counter value will be automatically deleted.
Program	<p>You can register user codes.</p> <ol style="list-style-type: none"> ① Press the [Program] key. ② Enter the User Code using the number keys. ③ Press the [OK] key.
Change	<p>You can change user codes.</p> <ol style="list-style-type: none"> ① Press the [Change] key. ② Press the User Code you want to change. ③ Enter new User Code using the number keys. ④ Press the [OK] key. <p> Note</p> <ul style="list-style-type: none"> <input type="checkbox"/> The number of copies made under the old code is added to that made under the new user code.

Menu	Description
Delete User Code	You can delete user codes. ① Press the [Delete User Code] key. ② Press the User Code you want to delete. ③ Press the [OK] key. ④ Press the [Yes] key.
Delete All User Codes	You can delete all user codes. ① Press the [Delete All User Code] key. ② Press the [Yes] key.
Connect Copy Master	You can choose whether the original modes are shown on the initial display.  Note <input type="checkbox"/> Default: <i>On</i>

Do's And Don'ts

CAUTION:

- *Unplug the power cord from the wall outlet before you move the equipment. While moving the equipment, you should take care that the power cord will not be damaged under the equipment.*
- Do not press areas on or around the fusing unit. These areas get hot.
- After making copies continuously, the exposure glass may feel warm—this is not a malfunction.
- You might feel warm around the ventilation hole. This is caused by exhaust air, and is not a malfunction.
- Do not turn off the operation switch while copying or printing. Make sure that all copying or printing has finished.
- The machine might fail to produce good copy images if condensation forms inside the machine due to rapid temperature change. To prevent this problem, the machine has an anti-condensation function. Even after the main power switch is in the stand-by position, the anti-condensation heater is active, thus keeping the machine body slightly warm.
- Do not open the covers of machine while copying or printing. If you do, mis-feeds might occur.
- Do not move the machine while copying or printing.
- If you operate the machine improperly or a failure occurs on the machine, your machine settings might be lost. Be sure to take a note of your machine settings.
- Supplier shall not be liable for any loss or damages resulting from a failure on the machine, loss of machine settings, and use of the machine.

Where to Put Your Machine

Machine Environment

Your machine's location should be carefully chosen because environmental conditions greatly affect its performance.

Optimum Environmental Conditions

⚠ CAUTION:

- *Keep the equipment away from humidity and dust. Otherwise a fire or an electric shock might occur.*
- *Do not place the equipment on an unstable or tilted surface. If it topples over, it could cause injury.*

⚠ CAUTION:

- *If you use the equipment in a confined space, make sure there is a continuous air turnover.*

- Temperature: 10 – 32°C (50 – 89.6°F) (humidity to be 54 % at 32°C, 89.6°F)
- Humidity: 15 – 80 % (temperature to be 27°C, 80.6°F at 80 %)
- A strong and level base.
- The machine must be level within 5 mm, 0.2" both front to rear and left to right.
- To avoid possible buildup of ozone, make sure to locate this machine in a large well ventilated room that has an air turnover of more than 30 m³/hr/person.

Environments To Avoid

- Locations exposed to direct sunlight or strong light (more than 1,500 lux).
- Locations directly exposed to cool air from an air conditioner or heated air from a heater. (Sudden temperature changes might cause condensation within the machine.)
- Locations close to such machines generating ammonia as diazo copy machine.
- Places where the machine might be subjected to frequent strong vibration.
- Dusty areas.
- Areas with corrosive gases.

Power Connection

⚠ WARNING:

- ***Only connect the machine to the power source described on the inside front cover of this manual. Connect the power cord directly into a wall outlet and do not use an extension cord.***
- ***Do not damage, break or make any modifications to the power cord. Do not place heavy objects on it. Do not pull it hard nor bend it more than necessary. These actions could cause an electric shock or fire.***

⚠ CAUTION:

- *Unplug the power cord from the wall outlet before you move the equipment. While moving the equipment, you should take care that the power cord will not be damaged under the equipment.*

⚠ CAUTION:

- *When you disconnect the power plug from the wall outlet, always pull the plug (not the cable).*
- When the main switch is in the Stand-by position, the optional anti-condensation heaters are on. In case of emergency, unplug the machine's power cord.
- When you unplug the power cord, the anti-condensation heaters turn off.
- Make sure the plug is firmly inserted in the outlet.
- Voltage must not fluctuate more than 10 %.

Access to Machine

Place the machine near the power source, providing clearance as shown.

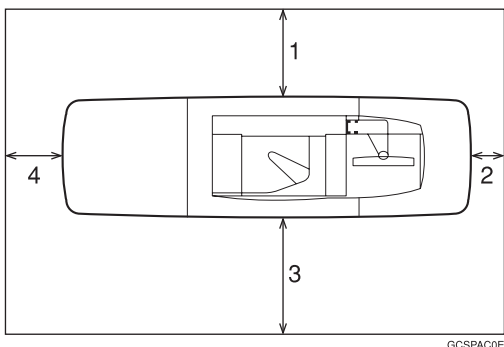

1. Rear: more than 20cm (7.8")
2. Right: more than 3cm (1.1")
3. Front: more than 55.5cm (21.6")
4. Left: more than 40cm (15.7")

Note

- For the required space when options are installed, please contact your service representative.

Maintaining Your Machine

If the exposure glass or document feeder belt is dirty, you might not be able to make copies as you want. Clean them if you find them dirty.

❖ Cleaning the machine

Wipe the machine with a soft, damp cloth. Then, wipe it with a dry cloth to remove the water.

⚠ Important

- ❑ Do not use chemical cleaner or organic solvent, such as thinner or benzene. If they get into the machine or melt plastic parts, a failure might occur.
- ❑ Do not clean parts other than those specified in this manual. Such parts should be cleaned by your service representative.

Cleaning the Exposure Glass

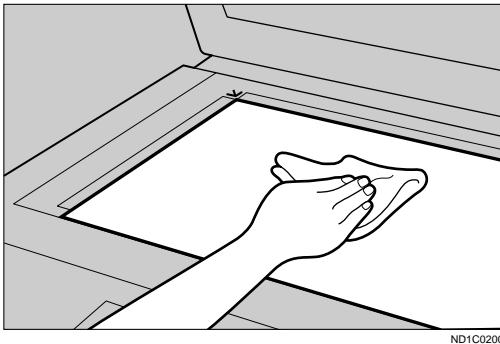

Cleaning the Document Feeder

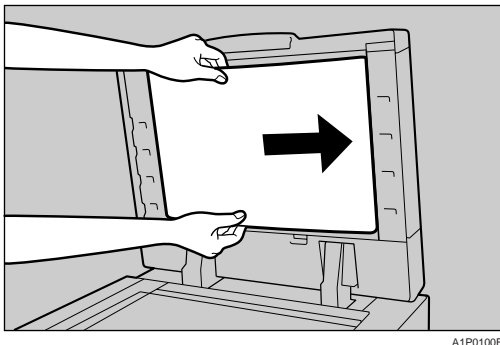

Stapling Position

When there is copy paper identical in size and direction to your original, the stapling position is as follows:

Original				Rotate Original +	Rotate Original +	Staple position

GGSTAP1E

8. Specification

Mainframe

- ❖ **Configuration:**
Console
- ❖ **Photosensitivity type:**
OPC drum (Ø100)
- ❖ **Original scanning:**
One-dimensional solid scanning system through CCD
- ❖ **Copy process:**
Dry electrostatic transfer system
- ❖ **Development:**
Dry two-component magnetic brush development system
- ❖ **Fusing:**
Heating roll pressure system
- ❖ **Resolution:**
600 dpi
- ❖ **Exposure glass:**
Stationary original exposure type
- ❖ **Original reference position:**
Rear left corner
- ❖ **Warm-up time:**
Less than 360 seconds (23°C)
- ❖ **Originals:**
Sheet/Book/Objects
- ❖ **Original size:**
A3☐ – A5☐☐, 11" × 17"☐ – 5¹/₂" × 8¹/₂"☐☐
- ❖ **Copy paper size:**
 - Tray1: A4☐, 8¹/₂" × 11"☐
 - Tray2, Tray3: A5☐- A3☐
 - Tray4-6: A5☐☐- A4☐, 5¹/₂" × 8¹/₂"☐☐- 8¹/₂" × 11"☐

❖ **Copy paper weight:**

- Tray 1 – Tray 3, Tray 6 : 52 - 163g/m², 16 lb. Bond - 90 lb. Index
- Tray 4, Tray 5: 52 – 216g/m², 16 lb. Bond - 80 lb. Cover

❖ **Non-reproduction area:**

- Leading edge: Less than 3 ± 2mm
- Trailing edge: More than 2 + 2/-1.7mm
- Left edge: More than 2 ± 1.5mm
- Right edge: More than 2 ± 1.5mm

❖ **First copy time:**

- 4.1 seconds or less
(A4 □, 8¹/₂" × 11" □, 100 %, feeding from tray 1 to Finisher Proof Tray, on the exposure glass, Text/Photo mode, Auto Image Density)

❖ **Copying speed:**

- 85 copies/minute (A4 □, 8¹/₂" × 11" □)
- 41 copies/minute (A3 □, 11" × 17" □)

❖ **Reproduction ratio:**

Preset reproduction ratios:

	Metric version	Inch version
Enlargement	400 %	400 %
	200 %	200 %
	141 %	155 %
	122 %	129 %
	115 %	121 %
Full Size	100 %	100 %
Reduction	93 %	93 %
	82 %	85 %
	75 %	78 %
	71 %	73 %
	65 %	65 %
	50 %	50 %
	25 %	25 %

Zoom: From 25 % to 400 % in 1 % steps.

❖ **Maximum number of continuous copy sets**

1 – 9999 copies

❖ Copy paper capacity:

- Tray 1 (Tandem tray) : 2,000 sheets (1,000 sheets × 2) (80g/m², 20 lb Bond)
- Tray 2 (500-sheet tray) : 500 sheets (80g/m², 20 lb Bond)
- Tray 3 (500-sheet tray) : 500 sheets (80g/m², 20 lb Bond)
- Tray 4 (LCT): 1,000 sheets (80g/m², 20 lb Bond)
- Tray 5 (LCT): 1,000 sheets (80g/m², 20 lb Bond)
- Tray 6 (LCT): 2,550 sheets (80g/m², 20 lb Bond)

❖ Power consumption:

	Mainframe Only	Full System ^{*1}
Warm-up	about 1.25 kw	about 1.27 kw
Stand-by	about 0.1 kw	about 0.12 kw
Copying	about 1.5 kw	about 1.6 kw
Maximum	less than 1.75 kw	less than 3 kw

^{*1} Mainframe with the finisher, large capacity tray

❖ Dimensions (W × D × H up to exposure glass):

2,096 × 735 × 1,476mm, 82.5" × 28.9" × 58.1"

❖ Space for main frame (W × D):

- 1,202 × 735 mm, 47.3" × 28.9" (ADF external extender is not used, optional Output tray is installed.)
- 2,218 × 735 mm, 87.3" × 28.9" (ADF external extender is used for larger size originals, optional Finisher Proof Tray is installed.)
- 2,314 × 735 mm, 91.1" × 28.9" (ADF external extender is used for larger size originals, optional Finisher Proof Tray is installed.)

❖ Noise Emission ^{*1}:

Sound Power Level

	Mainframe Only	Complete System ^{*3}
When printing	74 dB (A) or less	78 dB (A) or less
Stand-by	59 dB (A) or less	63 dB (A) or less

Sound Pressure Level ^{*2}

	Mainframe Only	Complete System ^{*3}
During printing	68 dB (A) or less	72 dB (A) or less

^{*1} The above measurements made ISO 7779 are actual value.

^{*2} It is measured at the position of the bystander. During Printing.

^{*3} Mainframe with the full options.

❖ **Weight:**







Approx. 252kg, 555.6 lb (mainmachine with document feeder)

Document Feeder

❖ Mode:

ADF mode, ARDF mode, Batch/SADF mode, Mixed Sizes mode, Thin mode

❖ Original size:

- A3  - A5  
- 11" × 17"  - 8¹/₂" × 5¹/₂"  



❖ Original weight:

- 1-sided originals: 52 - 156g/m² (14 - 42 lb. Bond)
- 2-sided originals: 52 - 128g/m² (14 - 34 lb. Bond) (Duplex)
- Thin paper mode: 40 - 156g/m² (11 - 42 lb. Bond)

❖ Number of originals that can be set:

100 sheets (80g/m², 20 lb. Bond) or less than 12 mm, 0.5"

❖ Copying speed:

72 copies/minute (A4 , 8¹/₂" × 11" , 1 to 1 copying)

❖ Power Source:





Power is supplied from the main frame.





Note





- Specifications are subject to change without notice.





Finisher

❖ Paper size:

Proof Tray: A3  - A5 , $8\frac{1}{2}'' \times 5\frac{1}{2}''$  - $11'' \times 17''$ 

Shift Tray: A3  - A5 , $8\frac{1}{2}'' \times 5\frac{1}{2}''$  - $11'' \times 17''$ 

Staple Mode: A3  - A4 , $11'' \times 17''$ , $8\frac{1}{2}'' \times 11''$  - $11'' \times 17''$ 

Punch Mode: A3  - A4 , $11'' \times 17''$ , $8\frac{1}{2}'' \times 11''$  - $11'' \times 17''$ 

❖ Paper weight:

Stack: 52 - 216 g/m², 14 lb. Bond - 80 lb. Covers)

Staple: 64 - 80 g/m², 17 - 20 lb. Bond)

Punch:

- 4 hokes: 52 - 128 g/m², 14 lb - 34 lb. Bond)
- 2 or 3 holes: 52 - 163 g/m², 14 lb. Bond - 90 lb. Index)

❖ Stack capacity:

Proof Tray:

- 500 sheets (A4, $8\frac{1}{2}'' \times 11''$ or smaller) (80g/m², 20 lb. Bond)
- 250 sheets (B4, $8\frac{1}{2}'' \times 14''$ or larger) (80g/m², 20 lb. Bond)

Shift Tray (without Punch):

- 3,000 sheets (A4, $8\frac{1}{2}'' \times 5\frac{1}{2}''$ or smaller) (80g/m², 20 lb. Bond)
- 1,500 sheets (B4, $8\frac{1}{2}'' \times 14''$ or larger) (80g/m², 20 lb. Bond)

Shift Tray (with Punch):

- 2,500 sheets (A4, $8\frac{1}{2}'' \times 5\frac{1}{2}''$ or smaller) (80g/m², 20 lb. Bond)
- 1,500 sheets (B4, $8\frac{1}{2}'' \times 14''$ or larger) (80g/m², 20 lb. Bond)

Shift Tray (with Staple):

- 10 - 100 originals = 200 - 30 sets (A4, $8\frac{1}{2}'' \times 5\frac{1}{2}''$) (80g/m², 20 lb. Bond)
- 1,500 sheets (B4, $8\frac{1}{2}'' \times 14''$ or larger) (80g/m², 20 lb. Bond)

❖ Staple capacity:

- 2 - 100 sheets (A4, $8\frac{1}{2}'' \times 11''$) (80g/m², 20 lb. Bond)
- 2 - 50 sheets (Others) (80g/m², 20 lb. Bond)

❖ Staple position:

Five positions (Top, Top Slant, Bottom, Left 2, Top 2)

❖ Power consumption:

140W (power is supplied from the main frame.)

❖ Dimensions (W × D × H):

800 × 728 × 980mm, 31.5" × 28.7" × 38.6"

❖ Weight:

Approx. 50kg, 130.1 lb

Note

- ❑ Specifications are subject to change without notice.

CD-RW (Option)

❖ **Storage: Number of files**

Up to 50 files

❖ **Power consumption:**

100-240V, 50/60Hz

❖ **Dimensions (W × D × H up to exposure glass):**

350 × 215mm × 300mm, 13.7" × 8.4" × 11.8"

❖ **Weight:**

Approx. 2.5kg, 5.5 lb

A3/11" × 17" Tray Kit (Option)

❖ **Paper Size:**

A3, B4, A4, 11" × 17", 8¹/₂" × 11", LG

❖ **Paper weight:**

52-163g/m², 14 lb. Bond-90 lb. Index

❖ **Copy paper capacity:**

1000 sheets (80g/m², 20 lb. Bond)

Punch Kit (Option)

❖ Paper size:

2 holes

- A3, B4, A4, B5, A5, 11" × 17", 11" × 15", 10" × 14", 8½" × 14", 8½" × 13", 8¼" × 13", 8" × 13", 8½" × 11", 8" × 10½", 8" × 10", 5½" × 8½", 210 × 340mm, 210 × 182mm, 210 × 170mm

3 holes

- A3, B4, A4, B5, 11" × 17", 11" × 15", 10" × 14", 8½" × 11"

❖ Paper weight:

- 2 holes version: 52 g/m² – 128 g/m², 14 – 34 lb
- 3 holes version: 52 g/m² – 105 g/m², 14 – 28 lb
- 4 holes version: 52 g/m² – 128 g/m², 14 – 34 lb

❖ Power consumption:

33.6 W (power is supplied from the mainframe.)

❖ Dimensions (W × D × H):

92 × 463 × 100 mm, 3.7" × 18.3" × 4.0"

❖ Weight:

Approx. 3kg, 6.6 lb

Note

- ❑ Specifications are subject to change without notice.

Large Capacity Tray (LCT) (Option)

❖ **Paper size:**

A4 □ – A5 □ □, 8¹/₂" × 5¹/₂" □ □ – 8¹/₂" × 11" □

❖ **Paper weight:**

Tray 4, Tray 5

- 52 - 216g/m², 16 lb. Bond - 80 lb. Covers

Tray 6

- 52 - 163g/m², 16 lb. Bond - 90 lb. Index

❖ **Paper capacity:**

Tray 4, Tray 5

- 1,000 sheets (80 g/m², 20 lb. Bond)

Tray 6

- 2,550 sheets (80 g/m², 20 lb. Bond)

❖ **Power consumption**

Maximum. 60 W (power is supplied from the main frame.)

❖ **Dimensions (W × D × H, option unit):**

540 × 727 × 986mm, 21.3" × 28.6" × 38.8"

❖ **Weight:**

Approx. 78.8kg, 173.7 lb

 **Note**

- Specifications are subject to change without notice.

Copy Connector Cable (Option)

- ❖ **Continuous copying speed:**
170 copies/minute models
- ❖ **Dimensions (W × D × H):**
310 × 310 × 65mm, 12.2" × 12.2" × 2.5"
- ❖ **Weight:**
Approx. 500g, 1.1 lb
- ❖ **Length:**
10m

INDEX

3 Side Full Bleed, 142

A

A3/11" × 17" Tray Kit, 346
Access to Machine, 336
Adding Staples, 299
Additional, 142
Auto Off, 25, 251
Auto Reset, 24, 250
Auto Start, 70

B

Back Cover, 151
Background Numbering, 165
Basic functions, 34
Batch (SADF) mode, 32
Book originals, copying, 120
Border Erase, 132

C

CD-RW, 345
Centering, 146
Changing Paper
 Tray 2 or 3, 294
Changing the Paper Size, 294
Changing the Toner Bottle, 283
Chapters, 158
Clearing Misfeeds, 286
Clear key, 7
Clear Modes/Energy Saver key, 7
Combination Chart, 193
Combine, 90
Connect Copy, 239, 241, 246, 349
 Document Server, 242
 Exiting, 251
 Interrupt, 242
 Relationship, 252
Control Panel, 7
Control panel, 4
Copying
 Connect Copy, 239
Copy Paper, 18
Cover
 Back Cover, 151
 Front Cover, 149

D

Date Stamp, 180
Delete Inside, 138
Delete Outside, 140
Designate/Chapters, 153
Directional Magnification (%), 79
Directional Size Magnification (inch), 82
Display, initial copy, 9
Display Panel, 8, 9
Document feeder, 4, 27, 248, 343
 Cleaning, 337
Document Server, 195
 Deleting, 224
 Features and Benefits, 197
 Printing, 204
 Scanning Originals, 199
Do's And Don'ts, 333
Double Copies, 143

E

Energy Saver mode, 68
Enlarging, 72
Environment, 334
Erase
 Border, 132
 Center/Border, 135
Erase Center, 135
Exposure glass, 4, 15, 17, 26
 Cleaning, 337

F

Finisher, 6, 241, 344
Front Cover, 4, 149

I

Image Density, 34, 35
Image Repeat, 145
Interrupt copy, 68
Interrupt key, 7

L

Large Capacity Tray (LCT), 6
LCT
 Sheet Large Capacity Tray, 348
Loading Paper, 277
 Large Capacity Tray, 280

Tray 1, 277
Tray 2 or 3, 279

M

Machine Environment, 334
Mainframe, 339
Main power switch, 4, 13
Maintenance, 337
Margin Adjustment, 130
Master Unit, 241
Messages, 261
Misfeeds, 286
Mixed sizes mode, 31

N

Numbering
 Background Numbering, 165
 Page Numbering, 183
Number keys, 8

O

On Demand Printing, 197
On indicator, 4
Operation switch, 4, 13
Options, 6
Original Mode Level, 242
Originals, 15, 247
Originals, setting, 26
Original Tone, 71
Original Type, selecting, 36

P

Page Numbering, 183
Panel Display, 243
Paper
 Changing, 294
 Loading, 277
Paper, having the machine choose, 38
Paper, selecting, 37
Paper tray, 4
Power Connection, 335
Preset Jobs, 60
Preset Stamp, 167
Program
 Storing, 55
Program key, 7
Programs, 55
Programs, deleting, 58
Programs, recalling, 59

Punching copies, 52
Punch kit, 347

R

Reduce/Enlarge, 72
Reduce/Enlarge, Auto, 40
Reducing, 72
Remarks, 333
Removing Jammed Staples, 302
Removing Punch Waste, 305
Repeat
 Image Repeat, 145

S

Safety information, i
Sample Copy, 71
Sample Copy key, 7
Save/Delete Area, 138
Scanned File Printing, 198
Screen Contrast Knob, 7
Series Copies, 116
Slip Sheets, 163
Sorting copies into sets, 44
Specification, 339, 344
 Connect Copy, 349
 Document Feeder, 343
 Mainframe, 339
 Punch Kit, 347
 Sheet Large Capacity Tray (LCT), 348
Stack, 47
Stamp
 Date Stamp, 180
 Preset Stamp, 167
 User Stamp, 171
Staple, 299
Staples
 Removing Jammed Staples, 302
Stapling copies, 49
Start key, 7
Stop, 7
Sub-Unit, 241
System indicators, 8

T

Thin mode, 32
Toner Bottle
 Changing, 283
 Storage, 21
Toner Cover, 4
Two-sided Copies, 84

U

User Codes, 70

User Stamp, 171

User Tools

Copier/Document Server Features, 307

Document Server, 330

Settings, 312

User Tools/Counter key, 8

V

Ventilation hole, 5

Z

Zoom, 75

New Machine Warranty and Limitation of Liability

Warranty – 90 days

Lanier warrants that its equipment and accessories will be free from defective parts and workmanship for a period of ninety (90) days from the date of first installation by Lanier's Authorized Dealer. Customers must notify a Lanier servicing dealer or Lanier of a warranty claim within the warranty period. For a listing of authorized Lanier servicing dealers or to notify Lanier of a warranty claim, write to Lanier Worldwide, Inc., 2300 Parklake Drive, N.E., Atlanta, Georgia 30345-2979.

Warranty Exclusions

THE FOREGOING EXPRESS WARRANTY IS MADE IN LIEU OF ALL OTHER PRODUCT WARRANTIES, EXPRESS OR IMPLIED, INCLUDING MERCHANTABILITY AND FITNESS AND THOSE ARISING FROM A COURSE OF DEALING OF USAGE OF TRADE. The Express Warranty will not apply to drums, cleaning blades, fuser cleaning felts, toner, developer or paper or to defects of damage incurred in transportation, or due to accident; neglect; misuse such as use of harmful or unapproved supplies; alterations; operator error; power surges; failure to properly install, clean, maintain, or repair; improper operating environment; or failure to provide proper utilities. The Express Warranty also will not apply to used or refurbished Lanier equipment unless Lanier expressly authorizes resale with its original equipment warranty.

Limitation of Liability

Fulfillment of Lanier's warranty obligation shall be the Customer's exclusive remedy and Lanier's and the Lanier Dealer's limit of liability for any breach of warranty or otherwise. In no event will Lanier or Lanier's Dealers be responsible or liable for special, incidental or consequential losses or damages.



Customer Vision® –
our commitment to your
complete satisfaction



your document management partner

www.lanier.com

Lanier Worldwide, Inc. | 2300 Parklake Drive, N.E. | Atlanta, GA USA 30345